

Pricelist
2020

memo

Contents

3	Terms of Sale	72	Prose Tables
4	Limited Lifetime Warranty	72	Free-Standing End Table
5	Customer Service	73	Free-Standing Coffee Table
6	Crating Fees	74	Linked Corner Table
7	Finishes Overview	75	Linked End Table
9	Textiles Overview	76	Linked Connecting Table
13	Chord Tables	77	Tenet
13	Personal Table	77	Daybed
15	Side Table	79	Array Casework
17	Coffee Table	79	Overview - Example Configurations
19	Chroma Seating	80	Standard Modules
19	Lounge	81	Standard Features, Options, and Finishes
21	Lounge Armless	82	Materials & Finishes Schedules
23	Lounge Swivel	82	Maharam Textiles Schedule
25	Ottoman	92	Corian Solid Surface Schedule
27	Low Table	93	Linoleum Schedule
29	High Table	94	Leather Arm Wrap Colors for Chroma
31	Penna Seating		
31	Lounge		
33	Penna Tables		
33	Large Round		
34	Obround		
35	Small Round		
36	Prose Seating		
36	Side Chair with Arms		
38	Side Chair Armless		
40	Plus Chair		
42	Two Seat Tandem		
46	Three Seat Tandem		
54	Settee		
56	Pull-Up Chair		
58	High Back Chair		
60	Bench		
62	Lounge		
64	Loveseat		
66	Sofa		
68	Ottoman		
70	Folding Chair		

Terms of Sale**Pricing Policy**

All prices shown for products and accessories are manufacturer's suggested list price. Prices shown do not include appropriate taxes, crating (if applicable), storage and installation charges. Memo reserves the right to amend price lists, change designs, and discontinue or add models without prior notice. Price list of latest date supersedes and cancels all previous lists. All orders accepted are subject to prices upon receipt of order.

Payment Terms

Except as otherwise specified, all orders require a 50% deposit with the balance due with thirty (30) days from the invoice date. All payments are payable in U.S. dollars. Lead times start after the receipt of deposit. Payments not made by the due date may incur, at the sole discretion of Memo, a late payment service charge of 1.5% per month. All payments and deposits are non-refundable.

Changes and Cancellations

Customers will receive a written confirmation of pricing, credit terms and estimated completion date. Changes to orders or cancellations made after production has begun will carry extra charges based on expenses incurred.

Shipping

Memo list prices include standard cartoning and standard surface freight to any point within the 48 contiguous United States. For shipments to Alaska, Hawaii and International destinations, additional shipping and handling charges will apply. Additional freight charges will be provided at the time of quote. Orders are shipped blanket wrapped as standard. If crating is requested or required, additional charges will apply. For a schedule of crating charges, please consult page 06 of this pricelist.

Freight Claims

Product is shipped FOB Factory, freight prepaid and allowed via truck. The title of goods changes to the purchaser when merchandise leaves Memo's dock and any subsequent freight damage and all freight claims are the responsibility of the purchaser. All shipments are transferred to the transportation company in good condition.

Custom Requests

Requests to modify existing products (Modifications) or to produce ground-up solutions (Specials) should be submitted to our customer service group, at which time they will be assessed and submitted for design and engineering approval. All custom requests will elicit a receipt and a response will be provided within 48 hours of receipt. Upon approval, a price and lead-time quote will be generated and provided for customer review and acceptance.

Limited Lifetime Warranty

Memo Furniture warrants its products, to the original user and for the original purpose, to be free of defects in design, material and workmanship, given normal use and care for the lifetime of the product from the date of invoice. This warranty does not include damage from accident, alteration, misuse, normal wear and tear, transportation or improper installation and maintenance.

During the warranty period, Memo Furniture, at its option, will repair or replace any product which, upon inspection by Memo Furniture or its designated representative, is deemed to be defective in materials or workmanship and is covered by this warranty.

This warranty does not apply to defects in components not manufactured by Memo Furniture. In these cases, the warranty period provided by the supplier of the component will apply. The liability of Memo Furniture is limited to furnishing new parts as may be necessary to replace any item that may prove to be defective in material or workmanship. Memo Furniture will make every effort to replace parts if they are available from the supplier of those parts. We will not assume liability of charges for labor, consequential expenses or damages incurred.

Textiles and leathers are not warranted against fading or normal wear, customer induced cuts or tears or irregularities in the registration of printed textile patterns. Due to natural variations, in which Memo Furniture has no control, this warranty does not extend to color, grain, texture or the durability or suitability of any exterior surface coatings or treatments.

This warranty is void in cases of damage in transit, negligence, abuse, abnormal usage, misuse, accidents, and improper cleaning and maintenance. Normal aging and wear of woven and non-woven upholstery are exempt from this warranty.

All other warranties, expressed or implied, are excluded. Memo Furniture shall not be liable for incidental or consequential damages of any sort.

If you have any questions or wish to file a claim against this warranty, please contact Customer Service at +1 206 995 8780.

Customer Service

Memo's Customer Service Group is trained to assist with quotes, orders, custom requests, product details, warranty inquires, and to answer general questions.

We can be reached Monday through Friday, 7:00 am – 5:00 pm Pacific Time, directly at +1 206 995 8780 or via email at info@memofurniture.com.

Inquiries received after-hours via voicemail or email will receive a response before the close of business on the following business day.

Please visit www.memofurniture.com for answers to most questions including product prices, specifications, photos, SketchUp and Revit files, and marketing material. Additionally, a local sales representative can assist you further. Contact names and numbers are also available on our website.

Crate Fee Schedule

Product	NET		
Array Drawer Modules		Penna Seating & Tables	
Drawer Module - Single	75	Lounge	125
Drawer Module - Double	100	Small Round Table	50
Drawer Module - Triple	125	Large Round Table	50
		Obround Table	50
Array Overhead Storage		Prose Seating & Tables	
Overhead Storage - Sngl.	75	Side Chair	75
Overhead Storage - Dbl.	100	Side Chair Armless	75
Overhead Storage - Trpl.	125	Plus Chair	85
		Settee	125
Array Work Stations		Two-Seat Tandem	150
Compact Work Station	150	Three-Seat Tandem	175
		High Back Chair	150
Array Sink Stations		Bench	125
Sink Only	75	Lounge	125
Sink + Drawer Left	125	Loveseat	150
Sink + Drawer Right	125	Sofa	175
		Ottoman	50
Array Wardrobes		Folding Chair	50
Wardrobe, Floor Based	125	Pull-Up Chair	85
Wall Mounted, Basic	125	Free-Standing End Table	50
Wall Mounted, Low	125	Free-Standing Coffee Table	50
		Linked Corner Table	50
Array Bridge Surfaces		Linked End Table	50
Bridge Table Surface - Single	75	Linked Connecting Table	50
Bridge Table Surface - Double	125		
		Tenet	
Chord Tables		Tenet Daybed	250
Personal Table	50		
Side Table	75		
Coffee Table	100		
Chroma Seating and Tables			
Lounge	125		
Lounge, Armless	125		
Lounge, Swivel	125		
Ottoman	50		
Low Table	75		
High Table	75		

Memo list prices include standard cartoning. The above fees apply when more durable crating is requested or required.

For larger quantities, crating fees may be reduced from the stated prices and reflected in the quote.

Finishes

Memo offers a range of proprietary colors and finishes on select materials, as well as support for a broad range of open line laminates and Corian solid surface. Our finishes have been curated to offer a foundation of essential base neutrals, to which accents and stronger colors can be added.

Memo offers finish and pattern selections in the following materials:

Metal Powder Coat

Our powder coats are applied to both steel and aluminum, and are available in textured and smooth finishes. Powder coating is extremely durable and emits zero pollutants once cured.

Natural Stone and Quartz

Memo offers natural stone and quartz on select table and horizontal surface tops. Our stone is hand selected from the highest quality slabs however natural variances will occur from product to product.

Solid Surface

Memo offers all Corian solid surface on most applicable products. Corian, is a non-porous high durability product that is stain resistant, easy to clean, and easily repairable.

Stainless Steel

Select products offer stainless steel as an alternate to Powder Coated Metal. Our stainless is 200 series, treated with a #4 brushed surface finish.

Wood & Veneer

Our products utilize both solid wood and wood veneer, and are offered in either Ash or Walnut. Products with edge profiles will include a matching wood edge. Wood products are finished in a resilient, long lasting, conversion varnish.

Memo Colors and Finishes

Metal Powder Coat

Light Gray Texture	MLG
Steel Gray Gloss	MSG
Med Bronze Gloss	MMB
Black Texture	MBT
Silver Metallic Gloss	MSM
Yellow Leaf Gloss	MYL
Copper Red Matte	MCR
Sage Green Matte	MGG
Navy Blue Matte	MNB

Natural Stone and Quartz

White Gray Marble	RWM
Valente Pearl Quartz	RVQ
Concrete Gray Quartz	RCQ
Indigo Swirl Quartz	RIQ
Onyx Carrara Quartz	ROQ

Stainless Steel

Brushed Stainless Steel	MSS
-------------------------	-----

Wood & Veneer

Clear over Ash	WCA
Oak Over Ash	WOA
Gray Over Ash	WGA
Walnut Over Ash	WWA
Clear Over Walnut	WCW
Navy Painted Wood	WNP

Memo Supported Open-Line Finishes

Corian - Solid Surface

Memo offers all Corian solid surface on most applicable products. For a list of Corian products by grade see page 92.

Linoleum

Memo offers Forbo furniture-grade linoleum on select products. See a list of available colors on page 93.

Textiles

Graded-in Textiles

Memo has partnered with Maharam to offer graded-in textiles. All graded-in textiles are listed by Pattern Name on page 82 and by Grading Group on page 87. Our Grading Groups and their LIST prices per yard are outlined below. Published product prices, including the cost of Graded-in Textiles, have been calculated by multiplying by the price per yard figures below by the yardage requirements indicated on a given product page.

Grading Group	LIST Price per Yard
1	44
2	56
3	69
4	81
5	94
6	113
7	138
8	163
9	188
10	219
11	256
12	294
13	375
14	438
15	563

Memo is glad to grade in textiles from suppliers other than Maharam, per customer requests. Please contact us to submit grading requests.

When specifying graded-in textiles the projected completion date of your order may exceed our normal lead times due to constraints of the textile supplier. In such instances, Memo will promptly communicate such delays and advise on adjusted lead times.

Textiles are subject to the quality and shipping standards of the provider. Memo assumes no responsibility for defects, color inaccuracies, shortages, wear, or performance of textiles.

Ordering a Textile Sample

Samples can be ordered by visiting the textile provider's website.

Textiles

Customer's Own Material (COM)

While we recommend selecting from our graded-in Maharam textile offer for the most streamlined process, we also provide the option to use COM. Memo, however, reserves the right to reject textiles which are unsuitable for upholstery on our products. This may be due to inadequate textile weight or unique elastic qualities which impact the integrity of upholstery on our products.

To select fabric outside of the graded-in fabric program, a few steps are required. Memo provides the total yardage for each product on its product spec sheets and pricelist reference pages. These published yardage figures are based on the application conditions of the cutting pattern for each product as well as managing quality issues. Certain textiles, depending on their width and/or repeat, may require additional yardage beyond the figures in our pricing pages. To calculate additional yardage, see our guidelines on page 12. Memo will also provide yardage requirements upon receipt of an order.

Upon receipt of the textile, Memo will immediately advise if flaws or deficiencies in the order are discovered. Memo assumes no responsibility for defects, color inaccuracies, shortages, wear, or sub-standard performance of the specified textiles.

Note that Memo will dispose of excess upholstery material at the time of shipment unless expressly requested to return it with the product shipment.

Customer's Own Leather (COL)

Please contact our customer service group at info@memofurniture.com or +1 206 995 8780.

Textiles**Delivery of Customer's Own Material (COM)**

Customers are responsible for ensuring delivery of COM fabric to Memo. Orders for COM-upholstered products will be scheduled into production upon receipt of all COM and swatches. Please work with our customer service group to procure written confirmation of textile supplier ship dates to ensure the best possible lead time. Since shipment of COM orders depends upon textile availability, lead times may vary.

When supplying COM textiles to Memo, please include the following info:

Textile supplier

Pattern name and number

Color name and number

A representative fabric swatch for identification purposes with face side marked

Any nonstandard treatments applied to the fabric

Any additional documentation

All COM or COL must be sent prepaid to the following address and tagged as follows:

C/O Memo Furniture

4660 Colorado Avenue South, Suite A

Seattle, WA 98134

Dealer name

P.O. #

Order code # (for each fabric)

Textiles**Order Requirements for Customer's Own Material (COM)**

Memo reserves the right to reject textiles or materials. Textiles requiring secondary backing or coatings should be treated prior to shipping to Memo. All yardage figures listed in Memo product spec sheets and pricelist reference pages are based on at least 54" Wide, Plain Fabric.

Increases for Textile Width and/or Repeat

In the event that COM textile is both less than 54" wide and also has a repeat, add both of the two increases shown below. For textiles that require matching (stripes, plaids, prints, pattern repeats) it is Memo's policy to match all pattern repeats, stripes, prints or plaids unless specified 'No Matching Required' on purchase order.

Fabric Bolts Less than 54" Wide

Less than 54" wide	Add 08%
Less than 50" wide	Add 13%
Less than 48" wide	Add 20%
Less than 45" wide	Add 50%
Less than 36" wide	Add 60%

Fabrics with Repeats

Repeat 7" & less	Add 11%
Repeat 13" & less	Add 18%
Repeat 21" & less	Add 21%
Repeat 27" & less	Add 24%
Repeat more than 27"	Add 25%

Order Requirements for Customer's Own Leather (COL)

COL orders are based on an average hide size of 45 square feet of usable leather and 19 feet per yard. Due to shape and quality issues with some leather, additional hides may be required after receipt of COL. Ship full hides only.

To convert COM yardage requirements to COL square footage and number of hides, multiply the COM yardage by 19.

Example: 5 yards x 19 = 95 square feet.

Chord

Personal Table

Designed by Standard Issue, 2019

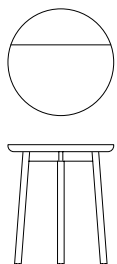

Depth	Width	Height
18"	18"	20.5"

Core Product	Core Code	List Price
Personal Table	MM01-T1	1182

Standard with Core Product

- Glides
- Open Tray Surface
- Powder Coated Steel Frame

Options

	Code	List Price Add
Large Insert Options		
Forbo Linoleum	FTL	243
Wood Veneer (Ash)	VAL	253
Wood Veneer (Walnut)	VWL	253
Small Insert Options		
No Insert (void)	XXS	0
Forbo Linoleum	FTS	37
Wood Veneer (Ash)	VAS	85
Wood Veneer (Walnut)	VWS	85
Stone/Quartz	STS	1032

Specifiable Finishes

- Linoleum Choose from Forbo linoleum products on page 93.
- Metal Choose from Memo Metal Powder Coat Finishes on page 8.
- Wood Choose from Memo Wood Finishes on page 8.
- Stone/Quartz Choose from Memo Stone & Quartz Finishes on page 8.

Reference Price Range

List Price COM: 1425–2544

Notes

Pricing includes Freight within Continental US.
For step-by-step specifications and quotes, access our live quote tool online at → [Quotes](#)

Chord

Side Table

Designed by Standard Issue, 2019

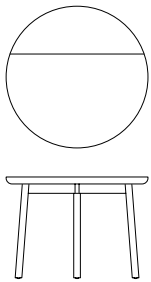

Depth	Width	Height
24"	24"	17.25"

Core Product	Core Code	List Price
Side Table	MM01-T2	1367

Standard with Core Product

- Glides
- Open Tray Surface
- Powder Coated Steel Frame

Options

	Code	List Price Add
Large Insert Options		
Forbo Linoleum	FTL	283
Wood Veneer (Ash)	VAL	316
Wood Veneer (Walnut)	VWL	316
Small Insert Options		
No Insert (void)	XXS	0
Forbo Linoleum	FTS	43
Wood Veneer (Ash)	VAS	88
Wood Veneer (Walnut)	VWS	88
Stone/Quartz	STS	1171

Specifiable Finishes

- Linoleum Choose from Forbo linoleum products on page 93.
- Metal Choose from Memo Metal Powder Coat Finishes on page 8.
- Wood Choose from Memo Wood Finishes on page 8.
- Stone/Quartz Choose from Memo Stone & Quartz Finishes on page 8.

Reference Price Range

List Price COM: 1650–2943

Notes

Pricing includes Freight within Continental US.
For step-by-step specifications and quotes, access our live quote tool online at → [Quotes](#)

Chord

Coffee Table

Designed by Standard Issue, 2019

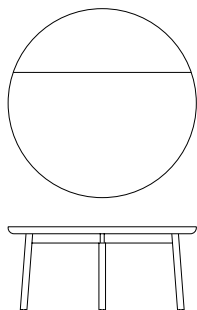

Depth	Width	Height
32"	32"	14.25"

Core Product	Core Code	List Price
Coffee Table	MM01-T3	1454

Standard with Core Product

- Glides
- Open Tray Surface
- Powder Coated Steel Frame

Options

	Code	List Price Add
Large Insert Options		
Forbo Linoleum	FTL	356
Wood Veneer (Ash)	VAL	415
Wood Veneer (Walnut)	VWL	415
Small Insert Options		
No Insert (void)	XXS	0
Forbo Linoleum	FTS	44
Wood Veneer (Ash)	VAS	95
Wood Veneer (Walnut)	VWS	95
Stone/Quartz	STS	1369

Specifiable Finishes

Linoleum	Choose from Forbo linoleum products on page 93.
Metal	Choose from Memo Metal Powder Coat Finishes on page 8.
Wood	Choose from Memo Wood Finishes on page 8.
Stone/Quartz	Choose from Memo Stone & Quartz Finishes on page 8.

Reference Price Range

List Price COM: 1810–3356

Notes

Pricing includes Freight within Continental US.

For step-by-step specifications and quotes, access our live quote tool online at → [Quotes](#)

Chroma

Lounge

Designed by Harri Koskinen, 2019

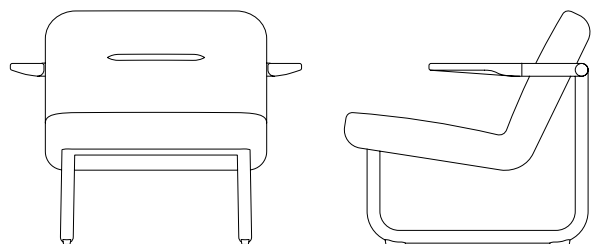

Depth	Width	Height
28.75"	33.75"	27.5"

Core Product

Lounge

Core Code

HK01-01

Textile Yardage

Total: 2.0

Seat	Back	Arms
n/a	n/a	n/a

List Price by Textile Grade

	COM	1	2	3	4	5	6	7	8	9	10	11	12	13	14	15
HK01-01	2410	2498	2522	2548	2572	2598	2636	2686	2736	2786	2848	2922	2998	3160	3286	3536

Standard with Core Product

Ash Arms

Non-Marring Glides

High Resilience Polyurethane Foam

Options and Notes overleaf

Options

Component	Code	List Price Add
Walnut Arms	WCW	180

Specifiable Finishes

- Metal Choose from Memo Metal Powder Coat Finishes on page 8.
- Textiles Choose from Maharam textiles, or contact Memo for assistance with COM fabrics
- Wood Choose from Memo Wood Finishes on page 8.

Reference Price Range

List Price: 2410-3716

Notes

Pricing includes Freight within Continental US.
Due to the continuous seat and back, multiple textiles are not permitted on Chroma Lounge
For step-by-step specifications and quotes, access our live quote tool online at → [Quotes](#)

Chroma

Lounge, Armless

Designed by Harri Koskinen, 2019

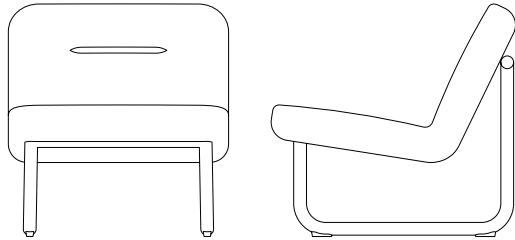

Depth	Width	Height
28.75"	26"	27.5"

Core Product

Lounge, Armless

Core Code

HK01-09

Textile Yardage

Total: 2.0

Seat	Back	Arms
n/a	n/a	n/a

List Price by Textile Grade

	COM	1	2	3	4	5	6	7	8	9	10	11	12	13	14	15
HK01-09	2189	2277	2301	2327	2351	2377	2415	2465	2515	2565	2627	2701	2777	2939	3065	3315

Standard with Core Product

Non-Marring Glides

High Resilience Polyurethane Foam

Options and Notes overleaf

Specifiable Finishes

Metal

Choose from Memo Metal Powder Coat Finishes on page 8.

Textiles

Choose from Maharam textiles, or contact Memo for assistance with COM fabrics

Reference Price Range

List Price: 2189-3315

Notes

Pricing includes Freight within Continental US.

Due to the continuous seat and back, multiple textiles are not permitted on Chroma Lounge

For step-by-step specifications and quotes, access our live quote tool online at → [Quotes](#)

Chroma

Lounge, Swivel

Designed by Harri Koskinen, 2019

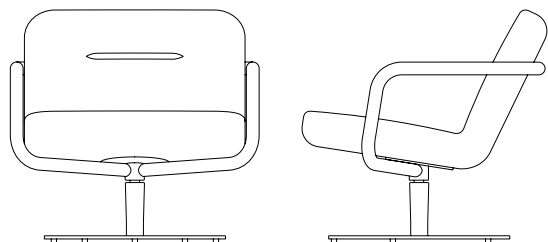

Depth	Width	Height
28.75"	29.25"	27.5"

Core Product

Lounge, Swivel

Core Code

HK01-11

Textile Yardage

Total: 2.0

Seat	Back	Arms
n/a	n/a	n/a

List Price by Textile Grade

	COM	1	2	3	4	5	6	7	8	9	10	11	12	13	14	15
HK01-11	2574	2662	2686	2712	2736	2762	2800	2850	2900	2950	3012	3086	3162	3324	3450	3700

Standard with Core Product

Free swivel base

High Resilience Polyurethane Foam

Non-Marring Glides

Options

Component	Code	List Price Add
Leather Arm Wrap	varies	287

Specifiable Finishes

- Leather Choose from Memo Leather Colors on page 94.
- Metal Choose from Memo Metal Powder Coat Finishes on page 8.
- Textiles Choose from Maharam textiles, or contact Memo for assistance with COM fabrics

Reference Price Range

List Price: 2574–3987

Notes

Pricing includes Freight within Continental US.
Due to the continuous seat and back, multiple textiles are not permitted on Chroma Lounge
For step-by-step specifications and quotes, access our live quote tool online at → [Quotes](#)

Chroma

Ottoman

Designed by Harri Koskinen, 2019

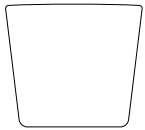
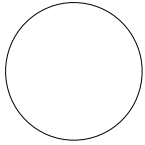

Depth	Width	Height
17.25"	17.25"	15.5"

Core Product

Ottoman

Core Code

HK01-00

Textile Yardage

Total: 1.50

Seat Back Arms

1.50 n/a n/a

List Price by Textile Grade

	COM	1	2	3	4	5	6	7	8	9	10	11	12	13	14	15
HK01-00	898	964	982	1002	1020	1039	1068	1105	1143	1180	1227	1282	1339	1461	1555	1743

Standard with Core Product

High Resilience Polyurethane Foam

Non-Marring Glides

Options and Notes overleaf

Specifiable Finishes

Textiles

Choose from Maharam textiles, or contact Memo for assistance with COM fabrics

Reference Price Range

List Price: 898–1743

Notes

Pricing includes Freight within Continental US.

For step-by-step specifications and quotes, access our live quote tool online at → [Quotes](#)

Chroma

Low Table

Designed by Harri Koskinen, 2019

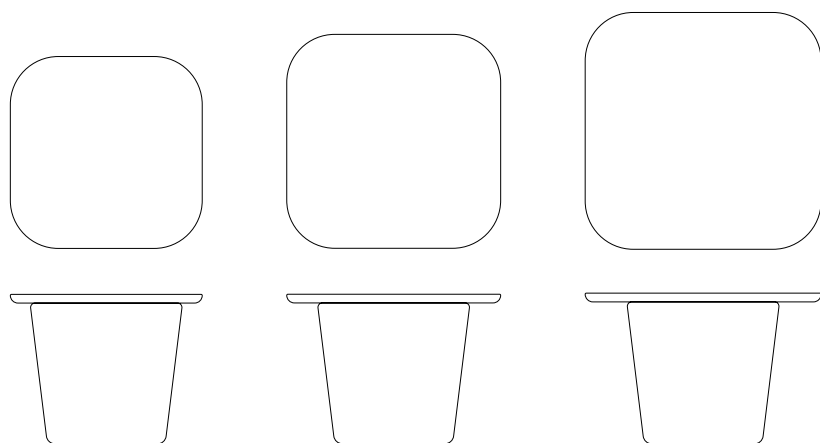

Depth	Width	Height	
22"	22"	17.5"	Small Top
24.5"	24.5"	17.5"	Mid Top
27"	27"	17.5"	Large Top

Core Product

Low Table - Small Top
Low Table - Mid Top
Low Table - Large Top

Core Code

HK01-T1-TSS
HK01-T1-TSM
HK01-T1-TSL

Textile Yardage

Total (base): 1.00

List Price by Textile Grade

	COM	1	2	3	4	5	6	7	8	9	10	11	12	13	14	15
HK01-T1-TSS	1144	1188	1200	1213	1225	1238	1257	1282	1307	1332	1363	1400	1438	1519	1582	1707
HK01-T1-TSM	1244	1288	1300	1313	1325	1338	1357	1382	1407	1432	1463	1500	1538	1619	1682	1807
HK01-T1-TSL	1344	1388	1400	1413	1425	1438	1457	1482	1507	1532	1563	1600	1638	1719	1782	1907

Standard with Core Product

Veneer Top (Ash)
High Resilience Polyurethane Foam
Non-Marring Glides

Options and Notes overleaf

Options

Component	Code	List Price Add
Veneer Top - Ash	VTA	0
Veneer Top - Walnut	VTW	21
Forbo Linoleum Top	FTT	52

Specifiable Finishes

- Linoleum Choose from Forbo linoleum products on page 93.
- Textiles Choose from Maharam textiles, or contact Memo for assistance with COM fabrics
- Veneer Choose from Memo Wood Finishes on page 8.

Reference Price Range

List Price COM: 1144-1396

Notes

Pricing includes Freight within Continental US.
For step-by-step specifications and quotes, access our live quote tool online at → [Quotes](#)

Chroma

High Table

Designed by Harri Koskinen, 2019

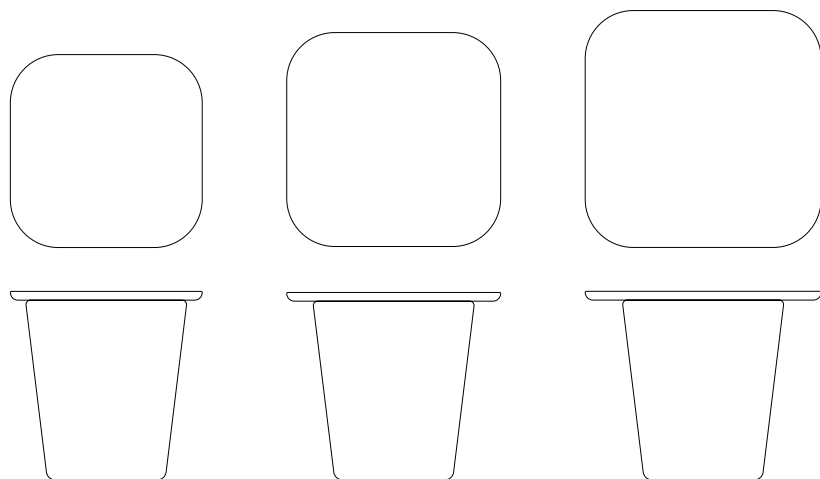

Depth	Width	Height	
22"	22"	21.75"	Small Top
24.5"	24.5"	21.75"	Mid Top
27"	27"	21.75"	Large Top

Core Product

High Table - Small Top
High Table - Mid Top
High Table - Large Top

Core Code

HK01-T2-TSS
HK01-T2-TSM
HK01-T2-TSL

Textile Yardage

Total (base): 1.00

List Price by Textile Grade

	COM	1	2	3	4	5	6	7	8	9	10	11	12	13	14	15
HK01-T2-TSS	1229	1273	1285	1298	1310	1323	1342	1367	1392	1417	1448	1485	1523	1604	1667	1792
HK01-T2-TSM	1329	1373	1385	1398	1410	1423	1442	1467	1492	1517	1548	1585	1623	1704	1767	1892
HK01-T2-TSL	1429	1473	1485	1498	1510	1523	1542	1567	1592	1617	1648	1685	1723	1804	1867	1992

Standard with Core Product

Veneer Top (Ash)
High Resilience Polyurethane Foam
Non-Marring Glides

Options and Notes overleaf

Options

Component	Code	List Price Add
Veneer Top - Ash	VTA	0
Veneer Top - Walnut	VTW	21
Forbo Linoleum Top	FTT	52

Specifiable Finishes

Linoleum	Choose from Forbo linoleum products on page 93.
Textiles	Choose from Maharam textiles, or contact Memo for assistance with COM fabrics
Veneer	Choose from Memo Wood Finishes on page 8.

Reference Price Range

List Price COM: 1229–1481

Notes

Pricing includes Freight within Continental US.

For step-by-step specifications and quotes, access our live quote tool online at → [Quotes](#)

Penna

Lounge

Designed by Studio Gorm, 2019

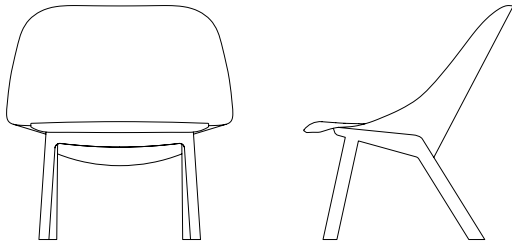

Depth	Width	Height
32"	25.5"	30"

Core Product

Lounge - Ash
Lounge - Walnut

Core Code

SG01-01-A
SG01-01-W

Textile Yardage

Total: 3.5

Seat	Back	Arms
1.0	2.5	n/a

List Price by Textile Grade*

	COM	1	2	3	4	5	6	7	8	9	10	11	12	13	14	15
SG01-01-A	2409	2563	2605	2651	2693	2738	2805	2892	2980	3067	3176	3305	3438	3722	3942	4380
SG01-01-W	2913	3067	3109	3155	3197	3242	3309	3396	3484	3571	3680	3809	3942	4226	4446	4884

*Pricing assumes a single textile selection for seat and back. For multiple textiles please visit → Quotes

Standard with Core Product

Non-Marring Glides
High Resilience Polyurethane Foam

Options and Notes overleaf

Options

Component	Code	List Price Add
Multiple Textiles (Seat/Back)	TA	50

Specifiable Finishes

- Textiles Choose from Maharam textiles, or contact Memo for assistance with COM fabrics
- Wood Choose from Memo Wood Finishes on page 8.

Reference Price Range

List Price COM: 2409–2963

Notes

- Pricing includes Freight within Continental US.
- Multiple Textile option allows for separate seat and back textiles.
- For step-by-step specifications and quotes, access our live quote tool online at → [Quotes](#)

Penna

Large Round Table

Designed by Studio Gorm, 2019

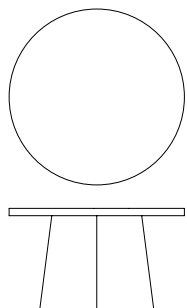

Depth	Width	Height
30"	30"	17.5"

Core Product	Core Code	List Price
Large Round Table - Ash	SG01-T1-A	2178
Large Round Table - Walnut	SG01-T1-W	2363

Standard with Core Product

- Glides
- Forbo Linoleum Top
- Solid Wood Edge Band (finish to match base)
- Wood Veneer Base

Options

Component	Code	List Price Add
Forbo Linoleum Top	FTT	0
Wood Veneer Top (Ash)	VTA	219
Wood Veneer Top (Walnut)	VTW	297

Specifiable Finishes

- Linoleum Choose from Forbo linoleum products on page 93.
- Wood Choose from Memo Wood Finishes on page 8.

Reference Price Range

List Price COM: 2178–2660

Notes

Pricing includes freight within Continental US.
For step-by-step specifications and quotes, access our live quote tool online at → Quotes

Penna

Obround Table

Designed by Studio Gorm, 2019

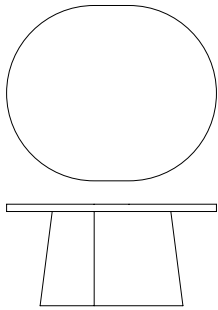

Depth	Width	Height
30"	36"	17.5"

Core Product	Core Code	List Price
Obround Table - Ash	SG01-T2-A	2345
Obround Table - Walnut	SG01-T2-W	2468

Standard with Core Product

- Glides
- Forbo Linoleum Top
- Solid Wood Edge Band (finish to match base)
- Wood Veneer Base

Options

Component	Code	List Price Add
Forbo Linoleum Top	FTT	0
Wood Veneer Top (Ash)	VTA	247
Wood Veneer Top (Walnut)	VTW	322

Specifiable Finishes

- Linoleum Choose from Forbo linoleum products on page 93.
- Wood Choose from Memo Wood Finishes on page 8.

Reference Price Range

List Price COM: 2345–2790

Notes

Pricing includes Freight within Continental US.
For step-by-step specifications and quotes, access our live quote tool online at → Quotes

Penna

Small Round Table

Designed by Studio Gorm, 2019

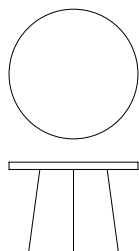

Depth	Width	Height
22.5"	22.5"	16"

Core Product	Core Code	List Price
Small Round Table - Ash	SG01-T3-A	1931
Small Round Table - Walnut	SG01-T3-W	2074

Standard with Core Product

- Glides
- Forbo Linoleum Top
- Solid Wood Edge Band (finish to match base)
- Wood Veneer Base

Options

Component	Code	List Price Add
Forbo Linoleum Top	FTT	0
Wood Veneer Top (Ash)	VTA	194
Wood Veneer Top (Walnut)	VTW	271

Specifiable Finishes

- Linoleum Choose from Forbo linoleum products on page 93.
- Wood Choose from Memo Wood Finishes on page 8.

Reference Price Range

List Price COM: 1931–2345

Notes

Pricing includes Freight within Continental US.
For step-by-step specifications and quotes, access our live quote tool online at → Quotes

Prose Seating

Side Chair with Arms

Designed by Memo Studio, 2017

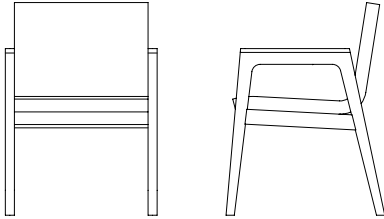

Depth	Width	Height
24"	23"	33"

Core Product

Side Chair with Arms - Ash
Side Chair with Arms - Walnut

Core Code

GC01-10-A
GC01-10-W

Textile Yardage	Seat	Back	Arms
Total: 1.50	n/a	n/a	n/a

List Price by Textile Grade

	COM	1	2	3	4	5	6	7	8	9	10	11	12	13	14	15
GC01-10-A	1,296	1,362	1,380	1,400	1,418	1,437	1,466	1,503	1,541	1,578	1,625	1,680	1,737	1,859	1,953	2,141
GC01-10-W	1,828	1,894	1,912	1,932	1,950	1,969	1,998	2,035	2,073	2,110	2,157	2,212	2,269	2,391	2,485	2,673

Standard with Core Product

Glides
High Resilience Polyurethane Foam
Solid Wood Arm Caps

Options and Notes overleaf

Options

Component	Code	List Price Add						
Solid Surface Arm Caps	by Grade (right)	CA1	CA2	CA3	CA4	CA5	CA6	CA7
		280	340	340	480	480	560	560
Removable Covers	RC	140						
Moisture Barrier	MB	140						
CAL TB 133	FB	140						

Specifiable Finishes

- Solid Surface Choose from Corian solid surface products on page 92
- Textiles Choose from Maharam textiles on page 82, or contact Memo for assistance with COM fabrics
- Wood Choose from Memo Wood Finishes on page 8

Reference Price Range

List Price COM: 1296--2808

Notes

Pricing includes Freight within Continental US.
 Due to its continuous seat and back, multiple fabric configurations are not supported on the Prose Side Chair with Arms.
 For step-by-step specifications and quotes, access our live quote tool online at memofurniture.com/quotes.

Prose Seating

Side Chair Armless

Designed by Memo Studio, 2017

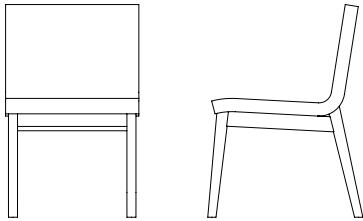

Depth	Width	Height
24"	20"	33"

Core Product

Side Chair Armless - Ash
Side Chair Armless - Walnut

Core Code

GC01-09-A
GC01-09-W

Textile Yardage	Seat	Back	Arms
Total: 1.50	n/a	n/a	n/a

List Price by Textile Grade

	COM	1	2	3	4	5	6	7	8	9	10	11	12	13	14	15
GC01-09-A	1,154	1,220	1,238	1,258	1,276	1,295	1,324	1,361	1,399	1,436	1,483	1,538	1,595	1,717	1,811	1,999
GC01-09-W	1,663	1,729	1,747	1,767	1,785	1,804	1,833	1,870	1,908	1,945	1,992	2,047	2,104	2,226	2,320	2,508

Standard with Core Product

Glides
High Resilience Polyurethane Foam

Options and Notes overleaf

Options

Component	Code	List Price Add
Removable Covers	RC	140
Moisture Barrier	MB	140
CAL TB 133	FB	140

Specifiable Finishes

Textiles Choose from Maharam textiles on page 82, or contact Memo for assistance with COM fabrics
Wood Choose from Memo Wood Finishes on page 8

Reference Price Range

List Price COM: 1154-2083

Notes

Pricing includes Freight within Continental US.
Due to its continuous seat and back, multiple fabric configurations are not supported on the Prose Side Chair Armless.
For step-by-step specifications and quotes, access our live quote tool online at memofurniture.com/quotes.

Prose Seating

Plus Chair

Designed by Memo Studio, 2017

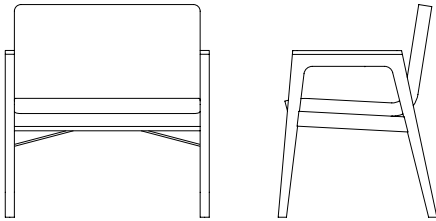

Depth	Width	Height
24"	30.75"	33"

Core Product

Plus Chair - Ash
Plus Chair - Walnut

Core Code

GC01-15-A
GC01-15-W

Textile Yardage	Seat	Back	Arms
Total: 2.00	n/a	n/a	n/a

List Price by Textile Grade

	COM	1	2	3	4	5	6	7	8	9	10	11	12	13	14	15
GC01-15-A	1,767	1,855	1,879	1,905	1,929	1,955	1,993	2,043	2,093	2,143	2,205	2,279	2,355	2,517	2,643	2,893
GC01-15-W	2,414	2,502	2,526	2,552	2,576	2,602	2,640	2,690	2,740	2,790	2,852	2,926	3,002	3,164	3,290	3,540

Standard with Core Product

Glides
High Resilience Polyurethane Foam
Solid Wood Arm Caps

Options and Notes overleaf

Options

Component	Code	List Price Add						
Solid Surface Arm Caps	by Grade (right)	CA1	CA2	CA3	CA4	CA5	CA6	CA7
		280	340	340	480	480	560	560
Removable Covers	RC	140						
Moisture Barrier	MB	140						
CAL TB 133	FB	140						

Specifiable Finishes

- Solid Surface Choose from Corian solid surface products on page 92
- Textiles Choose from Maharam textiles on page 82, or contact Memo for assistance with COM fabrics
- Wood Choose from Memo Wood Finishes on page 8

Reference Price Range

List Price COM: 1767-3394

Notes

Pricing includes Freight within Continental US.
 Due to its continuous seat and back, multiple fabric configurations are not supported on the Prose Plus Chair.
 For step-by-step specifications and quotes, access our live quote tool online at memofurniture.com/quotes.

Prose Seating

Two Seat Tandem

Designed by Memo Studio, 2017

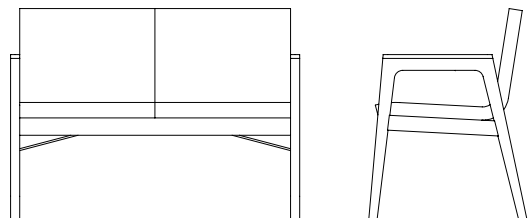

Depth	Width	Height
24"	43.5"	33"

Core Product

Two Seat Tandem - Ash

Two Seat Tandem - Walnut

Core Code

GC01-20-A

GC01-20-W

Module Variations

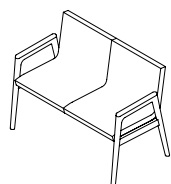

TAN-XX-TAN
(shown above)

Textile Yardage

Total: 2.5

Seat	Back	Arms
n/a	n/a	n/a

List Price by Textile Grade

	COM	1	2	3	4	5	6	7	8	9	10	11	12	13	14	15
GC01-20-A	2,025	2,157	2,193	2,232	2,268	2,307	2,364	2,439	2,514	2,589	2,682	2,793	2,907	3,150	3,339	3,714
GC01-20-W	2,930	3,062	3,098	3,137	3,173	3,212	3,269	3,344	3,419	3,494	3,587	3,698	3,812	4,055	4,244	4,619

Standard with Core Product

Glides

High Resilience Polyurethane Foam

Solid Wood Arm Caps

Options and Notes overleaf

Options

Intermediate Arm Variations

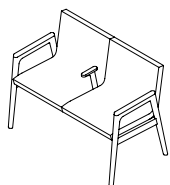

TAN-IA-TAN

Component	Code	List Price Add							
Intermediate Arm	IA	350							
Solid Surface Arm Caps	by Grade (right)		CA1	CA2	CA3	CA4	CA5	CA6	CA7
			280	340	340	480	480	560	560
Removable Covers	RC	170							
Moisture Barrier	MB	170							
CAL TB 133	FB	170							

Specifiable Finishes

- Solid Surface Choose from Corian solid surface products on page 92
- Textiles Choose from Maharam textiles on page 82, or contact Memo for assistance with COM fabrics
- Wood Choose from Memo Wood Finishes on page 8

Reference Price Range

List Price COM: 2025–4170

Notes

Pricing includes Freight within Continental US.
 Due to its continuous seat and back, multiple fabric configurations are not supported on the Prose Two Seat Tandem.
 For step-by-step specifications and quotes, access our live quote tool online at memofurniture.com/quotes.

Prose Seating

Two Seat Tandem

Designed by Memo Studio, 2017

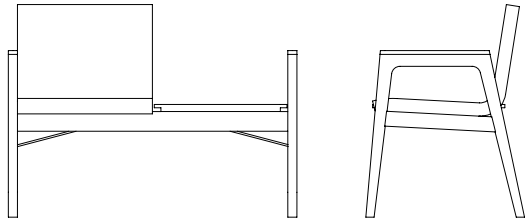

Depth	Width	Height
24"	43.5"	33"

Core Product

Two Seat Tandem - Ash

Two Seat Tandem - Walnut

Core Code

GC01-20-A

GC01-20-W

Module Variations

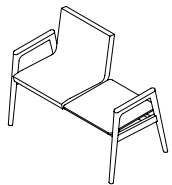

TAN-XX-INL
(shown above)

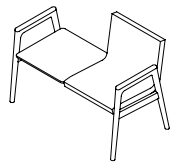

INL-XX-TAN

Textile Yardage

Total: 1.5

Seat Back Arms

n/a n/a n/a

List Price by Textile Grade

	COM	1	2	3	4	5	6	7	8	9	10	11	12	13	14	15
GC01-20-A	2,025	2,091	2,109	2,129	2,147	2,166	2,195	2,232	2,270	2,307	2,354	2,409	2,466	2,588	2,682	2,870
GC01-20-W	2,930	2,996	3,014	3,034	3,052	3,071	3,100	3,137	3,175	3,212	3,259	3,314	3,371	3,493	3,587	3,775

Standard with Core Product

Glides

High Resilience Polyurethane Foam

Forbo Linoleum Table Top

Solid Wood Arm Caps

Options and Notes overleaf

Options

Intermediate Arm Variations

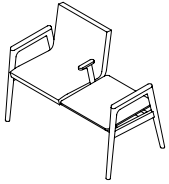

TAN-IA-INL

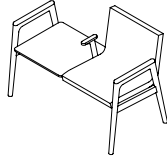

INL-IA-TAN

Component	Code	List Price							
Intermediate Arm	IA	350							
Solid Surface Arm Caps	by Grade (right)		CA1	CA2	CA3	CA4	CA5	CA6	CA7
			280	340	340	480	480	560	560
Solid Surface Table Top	by Grade (right)		CT1	CT2	CT3	CT4	CT5	CT6	CT7
			340	420	420	590	590	690	690
Wood Table Top (veneer)	VTA	0							
Removable Covers	RC	140							
Moisture Barrier	MB	140							
CAL TB 133	FB	140							

Specifiable Finishes

- Linoleum Choose from Forbo linoleum products on page 93
- Solid Surface Choose from Corian solid surface products on page 92
- Textiles Choose from Maharam textiles on page 82, or contact Memo for assistance with COM fabrics
- Wood Choose from Memo Wood Finishes on page 8

Reference Price Range

List Price COM: 2025–4950

Notes

Pricing includes Freight within Continental US.
 Due to its continuous seat and back, multiple fabric configurations are not supported on the Prose Two Seat Tandem.
 For step-by-step specifications and quotes, access our live quote tool online at memofurniture.com/quotes.

Prose Seating

Three Seat Tandem

Designed by Memo Studio, 2017

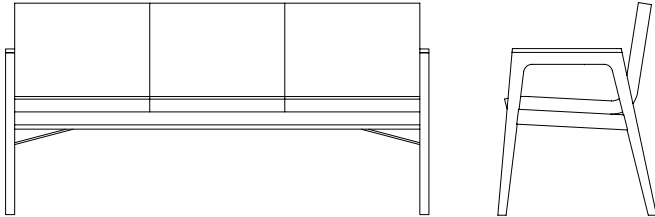

Depth	Width	Height
24"	64"	33"

Core Product

Three Seat Tandem - Ash
Three Seat Tandem - Walnut

Core Code

GC01-30-A
GC01-30-W

Module Variations

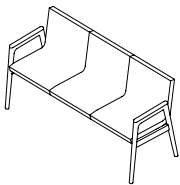

TAN-XX-TAN-XX-TAN
(shown above)

Textile Yardage

Total: 3.75

Seat	Back	Arms
n/a	n/a	n/a

List Price by Textile Grade

	COM	1	2	3	4	5	6	7	8	9	10	11	12	13	14	15
GC01-30-A	2,867	3,065	3,119	3,178	3,232	3,290	3,376	3,488	3,601	3,713	3,853	3,853	4,190	4,555	4,838	5,401
GC01-30-W	4,158	4,356	4,410	4,469	4,523	4,581	4,667	4,779	4,892	5,004	5,144	5,144	5,481	5,846	6,129	6,692

Standard with Core Product

- Glides
- High Resilience Polyurethane Foam
- Solid Wood Arm Caps

Options and Notes overleaf

Options

Intermediate Arm Variations

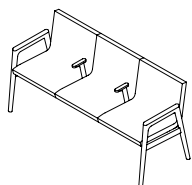

TAN-IA-TAN-IA-TAN

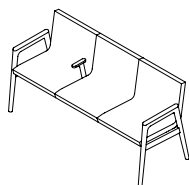

TAN-IA-TAN-XX-TAN

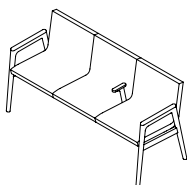

TAN-XX-TAN-IA-TAN

Component	Code	List Price Add							
Intermediate Arm	IA	(ea.) 350							
Solid Surface Arm Caps	by Grade (right)	CA1	CA2	CA3	CA4	CA5	CA6	CA7	
		280	340	340	480	480	560	560	
Removable Covers	RC	210							
Moisture Barrier	MB	210							
CAL TB 133	FB	210							

Specifiable Finishes

- Solid Surface Choose from Corian solid surface products on page 92
- Textiles Choose from Maharam textiles on page 82, or contact Memo for assistance with COM fabrics
- Wood Choose from Memo Wood Finishes on page 8

Reference Price Range

List Price COM: 2867–6048

Notes

Pricing includes Freight within Continental US.
 Due to its continuous seat and back, multiple fabric configurations are not supported on the Prose Three Seat Tandem.
 For step-by-step specifications and quotes, access our live quote tool online at memofurniture.com/quotes.

Prose Seating

Three Seat Tandem

Designed by Memo Studio, 2017

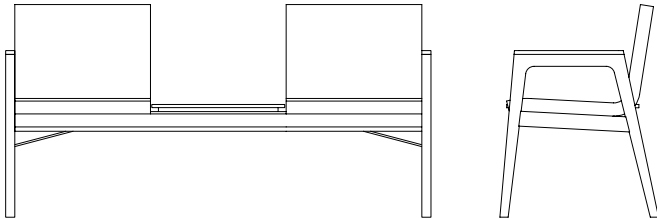

Depth	Width	Height
24"	64"	33"

Core Product

Three Seat Tandem - Ash
Three Seat Tandem - Walnut

Core Code

GC01-30-A
GC01-30-W

Module Variations

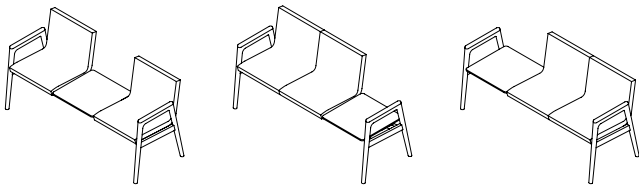

TAN-XX-INL-XX-TAN (shown above) TAN-XX-TAN-XX-INL INL-XX-TAN-XX-TAN

Textile Yardage

Total: 2.5	Seat	Back	Arms
	n/a	n/a	n/a

List Price by Textile Grade

	COM	1	2	3	4	5	6	7	8	9	10	11	12	13	14	15
GC01-30-A	2,867	2,999	3,035	3,074	3,110	3,149	3,206	3,281	3,356	3,431	3,524	3,524	3,749	3,992	4,181	4,556
GC01-30-W	4,158	4,290	4,326	4,365	4,401	4,440	4,497	4,572	4,647	4,722	4,815	4,815	5,040	5,283	5,472	5,847

Standard with Core Product

- Glides
- High Resilience Polyurethane Foam
- Forbo Linoleum Table Top
- Solid Wood Arm Caps

Options and Notes overleaf

Options

Intermediate Arm Variations

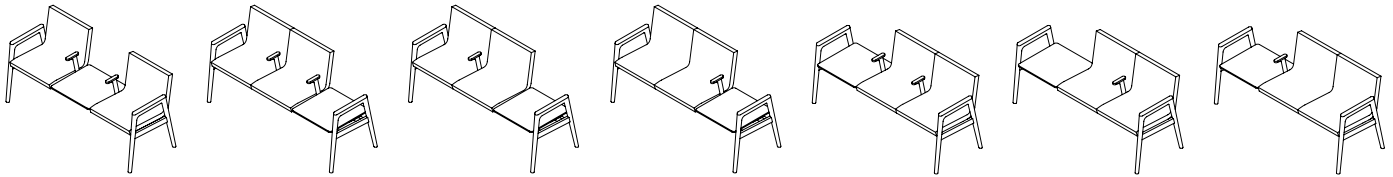

TAN-IA-INL-IA-TAN TAN-IA-TAN-IA-INL TAN-IA-TAN-XX-INL TAN-XX-TAN-IA-INL INL-IA-TAN-IA-TAN TAN-XX-TAN-IA-TAN TAN-IA-TAN-XX-TAN

Component	Code	List Price Add							
Intermediate Arm	IA	(ea.) 350							
Solid Surface Arm Caps	by Grade (right)	CA1	CA2	CA3	CA4	CA5	CA6	CA7	
		280	340	340	480	480	560	560	
Solid Surface Table Top	by Grade (right)	CT1	CT2	CT3	CT4	CT5	CT6	CT7	
		340	420	420	590	590	690	690	
Wood Table Top (veneer)	VTA	0							
Removable Covers	RC	170							
Moisture Barrier	MB	170							
CAL TB 133	FB	170							

Specifiable Finishes

- Linoleum Choose from Forbo linoleum products on page 93
- Solid Surface Choose from Corian solid surface products on page 92
- Textiles Choose from Maharam textiles on page 82, or contact Memo for assistance with COM fabrics
- Wood Choose from Memo Wood Finishes on page 8

Reference Price Range

List Price COM: 2867–6618

Notes

Pricing includes Freight within Continental US.
 Due to its continuous seat and back, multiple fabric configurations are not supported on the Prose Three Seat Tandem.
 For step-by-step specifications and quotes, access our live quote tool online at memofurniture.com/quotes.

Prose Seating

Three Seat Tandem

Designed by Memo Studio, 2017

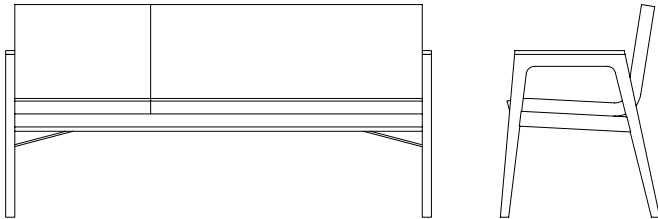

Depth	Width	Height
24"	64"	33"

Core Product

Two Seat Tandem - Ash
Two Seat Tandem - Walnut

Core Code

GC01-30-A
GC01-30-W

Module Variations

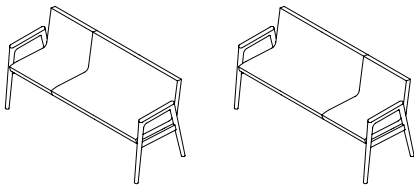

TAN-XX-SET-NA-NA (shown above) SET-NA-NA-XX-TAN

Textile Yardage

	Seat	Back	Arms
Total: 4.0	n/a	n/a	n/a

List Price by Textile Grade

	COM	1	2	3	4	5	6	7	8	9	10	11	12	13	14	15
GC01-30-A	2,867	3,043	3,091	3,143	3,191	3,243	3,319	3,419	3,519	3,619	3,743	3,743	4,043	4,367	4,619	5,119
GC01-30-W	4,158	4,334	4,382	4,434	4,482	4,534	4,610	4,710	4,810	4,910	5,034	5,034	5,334	5,658	5,910	6,410

Standard with Core Product

- Glides
- High Resilience Poyeurethane Foam
- Solid Wood Arm Caps

Options and Notes overleaf

Options

Intermediate Arm Variations

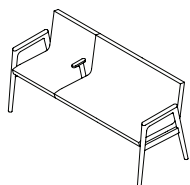

TAN-IA-SET-NA-NA

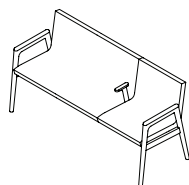

SET-NA-NA-IA-TAN

Component	Code	List Price Add						
Intermediate Arm	IA	350						
Solid Surface Arm Caps	by Grade (right)	CA1	CA2	CA3	CA4	CA5	CA6	CA7
		280	340	340	480	480	560	560
Removable Covers	RC	210						
Moisture Barrier	MB	210						
CAL TB 133	FB	210						

Specifiable Finishes

- Solid Surface Choose from Corian solid surface products on page 92
- Textiles Choose from Maharam textiles on page 82, or contact Memo for assistance with COM fabrics
- Wood Choose from Memo Wood Finishes on page 8

Reference Price Range

List Price COM: 2867–5698

Notes

Pricing includes Freight within Continental US.
 Due to its continuous seat and back, multiple fabric configurations are not supported on the Prose Three Seat Tandem.
 For step-by-step specifications and quotes, access our live quote tool online at memofurniture.com/quotes.

Prose Seating

Three Seat Tandem

Designed by Memo Studio, 2017

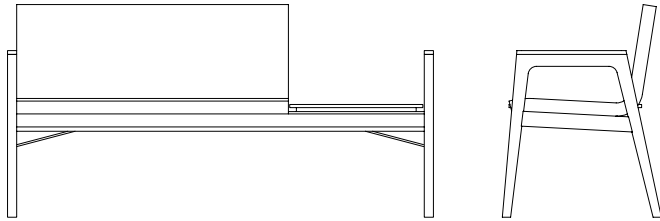

Depth	Width	Height
24"	64"	33"

Core Product

Two Seat Tandem - Ash

Two Seat Tandem - Walnut

Core Code

GC01-30-A

GC01-30-W

Module Variations

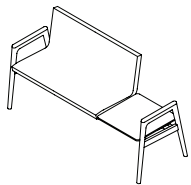

SET-NA-NA-XX-INL
(shown above)

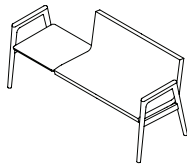

INL-XX-SET-NA-NA

Textile Yardage

Total: 2.5

Seat Back Arms

n/a n/a n/a

List Price by Textile Grade

	COM	1	2	3	4	5	6	7	8	9	10	11	12	13	14	15
GC01-30-A	2,867	2,977	3,007	3,040	3,070	3,102	3,150	3,212	3,275	3,337	3,415	3,415	3,602	3,805	3,962	4,275
GC01-30-W	4,158	4,268	4,298	4,331	4,361	4,393	4,441	4,503	4,566	4,628	4,706	4,706	4,893	5,096	5,253	5,566

Standard with Core Product

Glides

High Resilience Polyurethane Foam

Forbo linoleum Table Top

Solid Wood Arm Caps

Options and Notes overleaf

Options

Intermediate Arm Variations

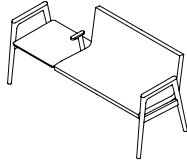
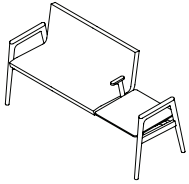

SET-NA-NA-IA-INL

INL-IA-SET-NA-NA

Component	Code	List Price Add							
Intermediate Arm	IA	350							
Solid Surface Arm Caps	by Grade (right)	CA1	CA2	CA3	CA4	CA5	CA6	CA7	
		280	340	340	480	480	560	560	
Solid Surface Table Top	by Grade (right)	CT1	CT2	CT3	CT4	CT5	CT6	CT7	
		340	420	420	590	590	690	690	
Wood Table Top (veneer)	VTA	0							
Removable Covers	RC	170							
Moisture Barrier	MB	170							
CAL TB 133	FB	170							

Specifiable Finishes

- Linoleum Choose from Forbo linoleum products on page 93
- Solid Surface Choose from Corian solid surface products on page 92
- Textiles Choose from Maharam textiles on page 82, or contact Memo for assistance with COM fabrics
- Wood Choose from Memo Wood Finishes on page 8

Reference Price Range

List Price COM: 2867-5918

Notes

Pricing includes Freight within Continental US.
 Due to its continuous seat and back, multiple fabric configurations are not supported on the Prose Three Seat Tandem.
 For step-by-step specifications and quotes, access our live quote tool online at memofurniture.com/quotes.

Prose Seating

Settee

Designed by Memo Studio, 2017

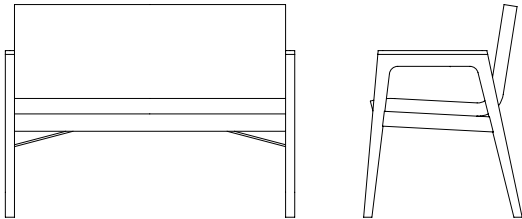

Depth	Width	Height
24"	43.75"	33"

Core Product

Settee - Ash
Settee - Walnut

Core Code

GC01-22-A
GC01-22-W

Textile Yardage	Seat	Back	Arms
Total: 2.50	n/a	n/a	n/a

List Price by Textile Grade

	COM	1	2	3	4	5	6	7	8	9	10	11	12	13	14	15
GC01-22-A	2,155	2,265	2,295	2,328	2,358	2,390	2,438	2,500	2,563	2,625	2,703	2,795	2,890	3,093	3,250	3,563
GC01-22-W	3,169	3,279	3,309	3,342	3,372	3,404	3,452	3,514	3,577	3,639	3,717	3,809	3,904	4,107	4,264	4,577

Standard with Core Product

Glides
High Resilience Poyeurethane Foam
Solid Wood Arm Caps

Options and Notes overleaf

Options

Component	Code	List Price Add						
Solid Surface Arm Caps	by Grade (right)	CA1	CA2	CA3	CA4	CA5	CA6	CA7
		280	340	340	480	480	560	560
Removable Covers	RC	170						
Moisture Barrier	MB	170						
CAL TB 133	FB	170						

Specifiable Finishes

- Solid Surface Choose from Corian solid surface products on page 92
- Textiles Choose from Maharam textiles on page 82, or contact Memo for assistance with COM fabrics
- Wood Choose from Memo Wood Finishes on page 8

Reference Price Range

List Price COM: 2155–4239

Notes

Pricing includes Freight within Continental US.
 Due to its continuous seat and back, multiple fabric configurations are not supported on the Prose Settee.
 For step-by-step specifications and quotes, access our live quote tool online at memofurniture.com/quotes.

Prose Seating

Pull-Up Chair

Designed by Memo Studio, 2017

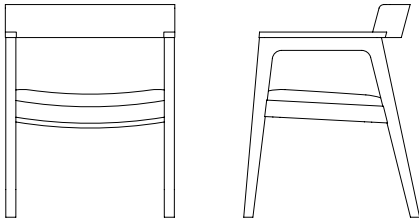

Depth	Width	Height
24"	23"	29.5"

Core Product

Pull-Up Chair - Ash
Pull-Up Chair - Walnut

Core Code

GC01-11-A
GC01-11-W

Textile Yardage	Seat	Back	Arms
Total: 1.00	n/a	n/a	n/a

List Price by Textile Grade

	COM	1	2	3	4	5	6	7	8	9	10	11	12	13	14	15
GC01-11-A	1,197	1,241	1,253	1,266	1,278	1,291	1,310	1,335	1,360	1,385	1,416	1,453	1,491	1,572	1,635	1,760
GC01-11-W	1,796	1,840	1,852	1,865	1,877	1,890	1,909	1,934	1,959	1,984	2,015	2,052	2,090	2,171	2,234	2,359

Standard with Core Product

Glides
High Resilience Polyurethane Foam
Solid Wood Arm Caps

Options and Notes overleaf

Options

Component	Code	List Price Add
Removable Covers	RC	140
Moisture Barrier	MB	140
CAL TB 133	FB	140

Specifiable Finishes

- Textiles Choose from Maharam textiles on page 82, or contact Memo for assistance with COM fabrics
- Wood Choose from Memo Wood Finishes on page 8

Reference Price Range

List Price COM: 1197-2116

Notes

Pricing includes Freight within Continental US.
For step-by-step specifications and quotes, access our live quote tool online at memofurniture.com/quotes.

Prose Seating

High Back Chair

Designed by Memo Studio, 2017

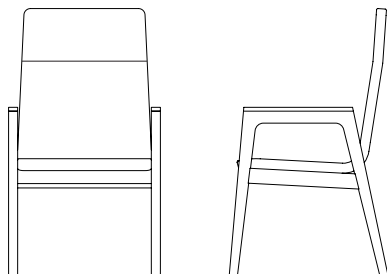

Depth	Width	Height
24"	23"	42.75"

Core Product

High Back Chair - Ash
High Back Chair - Walnut

Core Code

GC01-12-A
GC01-12-W

Textile Yardage

Total: 2.50

Seat	Back	Arms
-------------	-------------	-------------

n/a	n/a	n/a
-----	-----	-----

List Price by Textile Grade

	COM	1	2	3	4	5	6	7	8	9	10	11	12	13	14	15
GC01-12-A	1,515	1,625	1,655	1,688	1,718	1,750	1,798	1,860	1,923	1,985	2,063	2,155	2,250	2,453	2,610	2,923
GC01-12-W	2,055	2,165	2,195	2,228	2,258	2,290	2,338	2,400	2,463	2,525	2,603	2,695	2,790	2,993	3,150	3,463

Standard with Core Product

Glides
High Resilience Polyurethane Foam
Solid Wood Arm Caps

Options and Notes overleaf

Options

Component	Code	List Price Add						
Solid Surface Arm Caps	by Grade (right)	CA1	CA2	CA3	CA4	CA5	CA6	CA7
		280	340	340	480	480	560	560
Removable Covers	RC	140						
Moisture Barrier	MB	140						
CAL TB 133	FB	140						

Specifiable Finishes

- Solid Surface Choose from Corian solid surface products on page 92
- Textiles Choose from Maharam textiles on page 82, or contact Memo for assistance with COM fabrics
- Wood Choose from Memo Wood Finishes on page 8

Reference Price Range

List Price COM: 1515–3035

Notes

Pricing includes Freight within Continental US.
 Available in custom widths per engineering and quote approval.
 Due to its continuous seat and back, multiple fabric configurations are not supported on the Prose High Back Chair.
 For step-by-step specifications and quotes, access our live quote tool online at memofurniture.com/quotes.

Prose Seating

Bench

Designed by Memo Studio, 2017

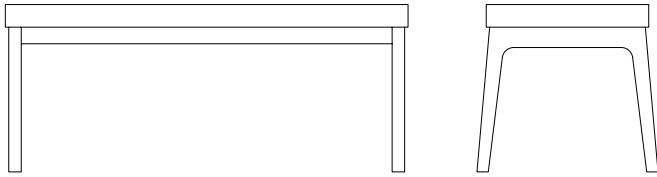

Depth	Width	Height
20"	43.5"	18.5"

Core Product

Bench - Ash
Bench - Walnut

Core Code

GC01-07-A
GC01-07-W

Textile Yardage

Total: 2.00

Seat Back Arms

n/a n/a n/a

List Price by Textile Grade

	COM	1	2	3	4	5	6	7	8	9	10	11	12	13	14	15
GC01-07-A	1,497	1,585	1,609	1,635	1,659	1,685	1,723	1,773	1,823	1,873	1,935	2,009	2,085	2,247	2,373	2,623
GC01-07-W	1,837	1,925	1,949	1,975	1,999	2,025	2,063	2,113	2,163	2,213	2,275	2,349	2,425	2,587	2,713	2,963

Standard with Core Product

Glides

High Resilience Polyurethane Foam

Options

Component	Code	List Price Add
Removable Covers	RC	140
Moisture Barrier	MB	140
CAL TB 133	FB	140

Specifiable Finishes

- Textiles Choose from Maharam textiles on page 82, or contact Memo for assistance with COM fabrics
- Wood Choose from Memo Wood Finishes on page 8

Reference Price Range

List Price COM: 1497-2257

Notes

Pricing includes Freight within Continental US.
Available in custom widths per engineering and quote approval.
For step-by-step specifications and quotes, access our live quote tool online at memofurniture.com/quotes.

Prose Seating

Lounge

Designed by Memo Studio, 2017

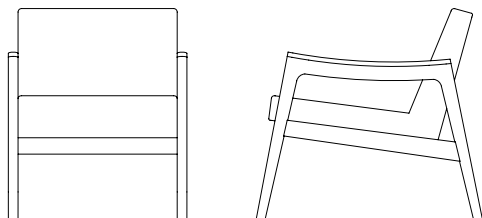

Depth	Width	Height
32"	25.5"	30"

Core Product

Lounge - Ash
Lounge - Walnut

Core Code

GC01-01-A
GC01-01-W

Textile Yardage	Seat	Back	Arms
Total: 2.00	1.00	1.00	n/a

List Price by Textile Grade

	COM	1	2	3	4	5	6	7	8	9	10	11	12	13	14	15
GC01-01-A	1965	2053	2077	2103	2127	2153	2191	2241	2291	2341	2403	2477	2553	2715	2841	3091
GC01-01-W	2676	2764	2788	2814	2838	2864	2902	2952	3002	3052	3114	3188	3264	3426	3552	3802

Standard with Core Product

Glides
High Resilience Polyurethane Foam
Solid Wood Arm Caps

Options and Notes overleaf

Options

Component	Code	List Price Add						
Solid Surface Arm Caps	by Grade (right)	CA1	CA2	CA3	CA4	CA5	CA6	CA7
		280	340	340	480	480	560	560
Removable Covers	RC	170						
Moisture Barrier	MB	170						
CAL TB 133	FB	170						
Multiple Textiles (Seat/Back)	TA	100						

Specifiable Finishes

- Solid Surface Choose from Corian solid surface products on page 92
- Textiles Choose from Maharam textiles on page 82, or contact Memo for assistance with COM fabrics
- Wood Choose from Memo Wood Finishes on page 8

Reference Price Range

List Price COM: 1965–3846

Notes

- Pricing includes Freight within Continental US.
- Available in custom widths per engineering and quote approval.
- Multiple fabric option allows for separate seat and back textiles.
- For step-by-step specifications and quotes, access our live quote tool online at memofurniture.com/quotes.

Prose Seating

Loveseat

Designed by Memo Studio, 2017

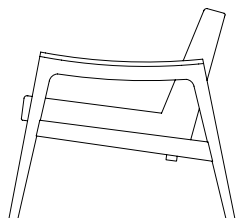
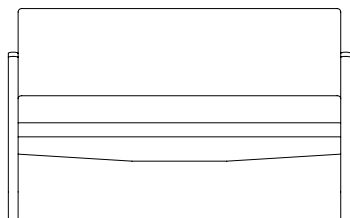

Depth	Width	Height
32"	48"	30"

Core Product

Loveseat - Ash
Loveseat - Walnut

Core Code

GC01-02-A
GC01-02-W

Textile Yardage	Seat	Back	Arms
Total: 4.00	2.00	2.00	n/a

List Price by Textile Grade

	COM	1	2	3	4	5	6	7	8	9	10	11	12	13	14	15
GC01-02-A	3409	3585	3633	3685	3733	3785	3861	3961	4061	4161	4285	4433	4585	4909	5161	5661
GC01-02-W	4394	4570	4618	4670	4718	4770	4846	4946	5046	5146	5270	5418	5570	5894	6146	6646

Standard with Core Product

Glides
High Resilience Polyurethane Foam
Solid Wood Arm Caps

Options and Notes overleaf

Options

Component	Code	List Price Add						
Solid Surface Arm Caps	by Grade (right)	CA1	CA2	CA3	CA4	CA5	CA6	CA7
		280	340	340	480	480	560	560
Removable Covers	RC	210						
Moisture Barrier	MB	210						
CAL TB 133	FB	210						
Multiple Textiles (Seat/Back)	TA	100						

Specifiable Finishes

- Solid Surface Choose from Corian solid surface products on page 92
- Textiles Choose from Maharam textiles on page 82, or contact Memo for assistance with COM fabrics
- Wood Choose from Memo Wood Finishes on page 8

Reference Price Range

List Price COM: 3409–5684

Notes

- Pricing includes Freight within Continental US.
- Available in custom widths per engineering and quote approval.
- Multiple fabric option allows for separate seat and back textiles.
- For step-by-step specifications and quotes, access our live quote tool online at memofurniture.com/quotes.

Prose Seating

Sofa

Designed by Memo Studio, 2017

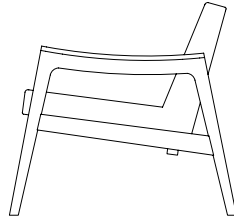
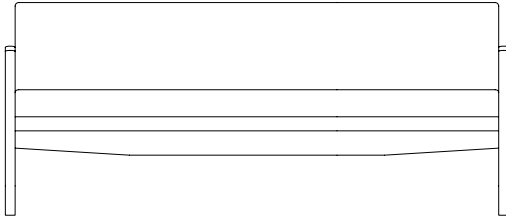

Depth	Width	Height
32"	70"	30"

Core Product

Sofa - Ash
Sofa - Walnut

Core Code

GC01-03-A
GC01-03-W

Textile Yardage	Seat	Back	Arms
Total: 5.00	2.50	2.50	n/a

List Price by Textile Grade

	COM	1	2	3	4	5	6	7	8	9	10	11	12	13	14	15
GC01-03-A	3852	4072	4132	4197	4257	4322	4417	4542	4667	4792	4947	5132	5322	5727	6042	6667
GC01-03-W	4689	4909	4969	5034	5094	5159	5254	5379	5504	5629	5784	5969	6159	6564	6879	7504

Standard with Core Product

Glides
High Resilience Polyurethane Foam
Solid Wood Arm Caps

Options and Notes overleaf

Options

Component	Code	List Price Add						
Solid Surface Arm Caps	by Grade (right)	CA1	CA2	CA3	CA4	CA5	CA6	CA7
		280	340	340	480	480	560	560
Removable Covers	RC	250						
Moisture Barrier	MB	250						
CAL TB 133	FB	250						
Multiple Textiles (Seat/Back)	TA	100						

Specifiable Finishes

- Solid Surface Choose from Corian solid surface products on page 92
- Textiles Choose from Maharam textiles on page 82, or contact Memo for assistance with COM fabrics
- Wood Choose from Memo Wood Finishes on page 8

Reference Price Range

List Price COM: 3852–5899

Notes

- Pricing includes Freight within Continental US.
- Available in custom widths per engineering and quote approval.
- Multiple fabric option allows for separate seat and back textiles.
- For step-by-step specifications and quotes, access our live quote tool online at memofurniture.com/quotes.

Prose Seating

Ottoman

Designed by Memo Studio, 2017

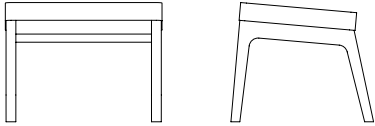

Depth	Width	Height
20"	21.5"	17"

Core Product

- Ottoman - Ash
- Ottoman - Walnut

Core Code

- GC01-00-A
- GC01-00-W

Textile Yardage

Total: 1.00

List Price by Textile Grade

	COM	1	2	3	4	5	6	7	8	9	10	11	12	13	14	15
GC01-00-A	760	804	816	829	841	854	873	898	923	948	979	1,016	1,054	1,135	1,198	1,323
GC01-00-W	1,107	1,151	1,163	1,176	1,188	1,201	1,220	1,245	1,270	1,295	1,326	1,363	1,401	1,482	1,545	1,670

Standard with Core Product

- Glides
- High Resilience Poyeurethane Foam

Options

Component	Code	List Price Add
Removable Covers	RC	140
Moisture Barrier	MB	140
CAL TB 133	FB	140

Specifiable Finishes

- Textiles Choose from Maharam textiles on page 82, or contact Memo for assistance with COM fabrics
- Wood Choose from Memo Wood Finishes on page 8

Reference Price Range

List Price COM: 760– 1527

Notes

Pricing includes Freight within Continental US.
Designed to be used with the Prose Lounge Chair.
For step-by-step specifications and quotes, access our live quote tool online at memofurniture.com/quotes.

Prose Seating

Folding Chair

Designed by Memo Studio, 2017

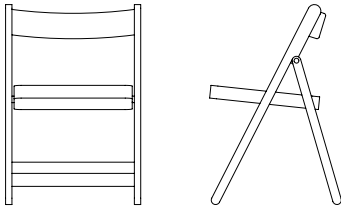

Depth	Width	Height
22"	21.5"	31"

Core Product

Folding Chair - Ash
Folding Chair - Walnut

Core Code

GC01-08-A
GC01-08-W

Textile Yardage

Total: 1.00

Seat	Back	Arms
n/a	n/a	n/a

List Price by Textile Grade

	COM	1	2	3	4	5	6	7	8	9	10	11	12	13	14	15
GC01-08-A	920	964	976	989	1,001	1,014	1,033	1,058	1,083	1,108	1,139	1,176	1,214	1,295	1,358	1,483
GC01-08-W	1,266	1,310	1,322	1,335	1,347	1,360	1,379	1,404	1,429	1,454	1,485	1,522	1,560	1,641	1,704	1,829

Standard with Core Product

Glides

High Resilience Polyurethane Foam

Options and Notes overleaf

Options

Component	Code	List Price Add
Hanging Fixture	DJ	185
Moisture Barrier	MB	140
CAL TB 133	FB	140

Specifiable Finishes

- Textiles Choose from Maharam textiles on page 82, or contact Memo for assistance with COM fabrics
- Wood Choose from Memo Wood Finishes on page 8

Reference Price Range

List Price COM: 920- 1731

Notes

- Pricing includes Freight within Continental US.
- Removeable seat cover is not available for the Prose Folding Chair.
- For step-by-step specifications and quotes, access our live quote tool online at memofurniture.com/quotes.

Prose Tables

Free-Standing End Table
Designed by Memo Studio, 2017

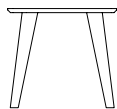

Depth	Width	Height
20"	20"	18.5"

Core Product	Core Code	List Price
Free-Standing End Table - Ash	GC01-T1-A	1134
Free-Standing End Table - Walnut	GC01-T1-W	1575

Standard with Core Product

Glides
Forbo Linoleum Top

Options

Component	Code	List Price Add						
Solid Surface Table Top	by Grade (right)	CT1	CT2	CT3	CT4	CT5	CT6	CT7
		340	420	420	590	590	690	690
Solid Wood Table Top - Ash	WTA	340						
Solid Wood Table Top - Walnut	WTW	510						

Specifiable Finishes

Linoleum Choose from Forbo linoleum products on page 93
 Solid Surface Choose from Corian solid surface products on page 92
 Wood Choose from Memo Wood Finishes on page 8

Reference Price Range

List Price COM: 1134-2265

Notes

Pricing includes Freight within Continental US.
 For step-by-step specifications and quotes, access our live quote tool online at memofurniture.com/quotes.

Prose Tables

Free-Standing Coffee Table
Designed by Memo Studio, 2017

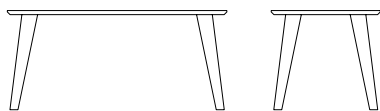

Depth	Width	Height
20"	40"	18.5"

Core Product	Core Code	List Price
Free-Standing Coffee Table - Ash	GC01-T2-A	1407
Free-Standing Coffee Table - Walnut	GC01-T2-W	1793

Standard with Core Product

- Glides
- Forbo Linoleum Top

Options

Component	Code	List Price Add						
Solid Surface Table Top	by Grade (right)	CT1	CT2	CT3	CT4	CT5	CT6	CT7
		340	420	420	590	590	690	690
Solid Wood Table Top - Ash	WTA	340						
Solid Wood Table Top - Walnut	WTW	510						

Specifiable Finishes

- Linoleum: Choose from Forbo linoleum products on page 93
- Solid Surface: Choose from Corian solid surface products on page 92
- Wood: Choose from Memo Wood Finishes on page 8

Reference Price Range

List Price COM: 1407-2483

Notes

Pricing includes Freight within Continental US.
For step-by-step specifications and quotes, access our live quote tool online at memofurniture.com/quotes.

Prose Tables

Linked Corner Table

Designed by Memo Studio, 2017

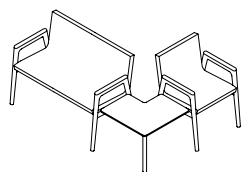
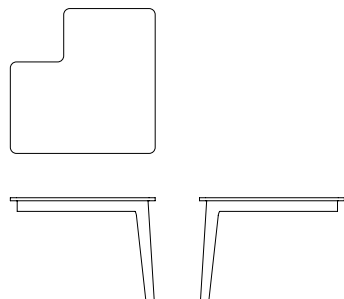

Example application with
GC01-22 & GC01-10

Depth	Width	Height
28"	28"	17"

Core Product

Linked Corner Table - Ash
Linked Corner Table - Walnut

Core Code

GC01-T6-A
GC01-T6-W

List Price

820
1220

Standard with Core Product

Glides
Forbo Linoleum Table Top

Options

Component	Code	List Price Add						
Solid Surface Table Top	by Grade (right)	CT1	CT2	CT3	CT4	CT5	CT6	CT7
		340	420	420	590	590	690	690
Wood Table Top (vener)	VTA	0						

Specifiable Finishes

Linoleum Choose from Forbo linoleum products on page 93
 Solid Surface Choose from Corian solid surface products on page 92
 Wood Choose from Memo Wood Finishes on page 8

Reference Price Range

List Price COM: 820–1910

Notes

Pricing includes Freight within Continental US.
 For step-by-step specifications and quotes, access our live quote tool online at memofurniture.com/quotes.

Prose Tables

Linked End Table

Designed by Memo Studio, 2017

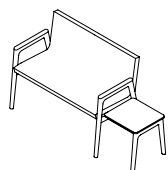
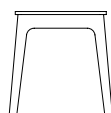
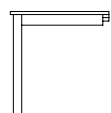
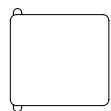

Example application with GC01-22

Depth	Width	Height
16.75"	18"	17"

Core Product

Linked End Table - Ash
Linked End Table - Walnut

Core Code

GC01-T7-A
GC01-T7-W

List Price

820
1220

Standard with Core Product

Glides
Forbo Linoleum Table Top

Options

Component	Code	List Price Add						
Solid Surface Table Top	by Grade (right)	CT1	CT2	CT3	CT4	CT5	CT6	CT7
		340	420	420	590	590	690	690
Wood Table Top (veneer)	VTA	0						

Specifiable Finishes

Linoleum Choose from Forbo linoleum products on page 93
Solid Surface Choose from Corian solid surface products on page 92
Wood Choose from Memo Wood Finishes on page 8

Reference Price Range

List Price COM: 820–1910

Notes

Pricing includes Freight within Continental US.
For step-by-step specifications and quotes, access our live quote tool online at memofurniture.com/quotes.

Prose Tables

Linked Connecting Table
Designed by Memo Studio, 2017

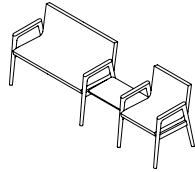
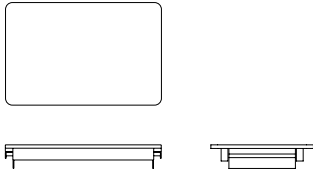

Example application
with GC01-22 & GC01-10

Depth	Width	Height
15"	22"	3.25"

Core Product	Core Code	List Price
Linked Connecting Table - Ash	GC01-T8-A	820
Linked Connecting Table - Walnut	GC01-T8-W	1220

Standard with Core Product
Forbo Linoleum Table Top

Options

Component	Code	List Price Add						
Solid Surface Table Top	by Grade (right)	CT1	CT2	CT3	CT4	CT5	CT6	CT7
		340	420	420	590	590	690	690
Wood Table Top (veneer)	VTA	0						

Specifiable Finishes

- Linoleum Choose from Forbo linoleum products on page 93
- Solid Surface Choose from Corian solid surface products on page 92
- Wood Choose from Memo Wood Finishes on page 8

Reference Price Range
List Price COM: 820–1910

Notes

Pricing includes Freight within Continental US.
For step-by-step specifications and quotes, access our live quote tool online at memofurniture.com/quotes.

Tenet

Daybed

Designed by George Simons Jr., 2017

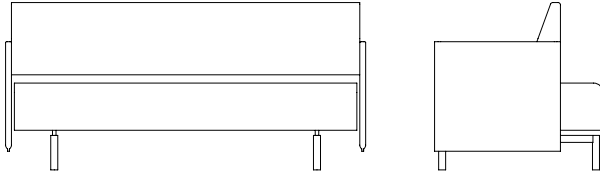

Depth	Width	Height
36"	77.5"	34"

Core Product

- Daybed - Low Arms (27.5")
- Daybed - Mid Arms (38")
- Daybed - High Arms (50")

Core Code

- GS01-37-LA
- GS01-37-MA
- GS01-37-HA

Textile Yardage	Seat	Back	Arms
Low Arms - Total: 8.00	3.00	3.00	2.00
Mid Arms - Total: 10.25	3.00	3.00	4.25
High Arms - Total: 11.50	3.00	3.00	5.50

List Price by Textile Grade

	COM	1	2	3	4	5	6	7	8	9	10	11	12	13	14	15
GS01-37-LA	5931	6283	6379	6483	6579	6683	6835	7035	7235	7435	7683	7979	8283	8931	9435	10435
GS01-37-MA	6271	6722	6845	6978	7101	7235	7429	7686	7942	8198	8516	8895	9285	10115	10761	12042
GS01-37-HA	6381	6887	7025	7175	7313	7462	7681	7968	8256	8543	8900	9325	9762	10694	11418	12856

Standard with Core Product

- High Resilience Polyurethane Foam
- Non-Marring Glides
- Powder Coated Metal Legs
- Proprietary Sliding Mechanism

Options and Notes overleaf

Options

Component	Code	List Price Add
Wood Legs	LW	350
Casters	CAS	340
Removeable Arm Pads (pair)	AP	330
Removable Covers	RC	280
Moisture Barrier	MB	340
CAL TB 133	FB	1000
Mult. Textiles (Arm 1, Seat/Back 2)	AT	100
Mult. Textiles (Seat 1, Arm/Back 2)	ST	100
Mult. Textiles (Back 1, Arm/Seat 2)	BT	100

Specifiable Finishes

Leather

Metal

Choose from Memo Metal Finishes on page 8

Textiles

Choose from Maharam textiles on page 82, or contact Memo for assistance with COM fabrics

Wood

Choose from Memo Wood Finishes on page 8

Reference Price Range

List Price COM: 5931–9121

Notes

Pricing includes Freight within Continental US.

For step-by-step specifications and quotes, access our live quote tool online at memofurniture.com/quotes.

Array Casework

Designed by George Simons Jr., 2017

Array modular casework offers continuity of line, form, and detail across a broad range of standard and custom configurations. Shown on this page are examples of standard configurations, although there are endless combination possibilities

Left:
Exam Room Sink Station

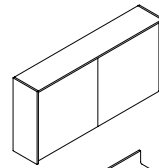

Right:
Expanded Exam Room Sink Station

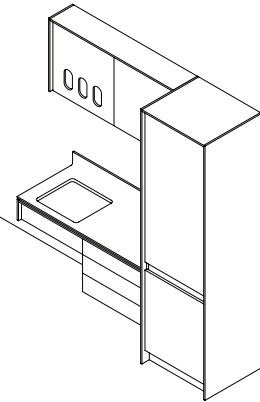
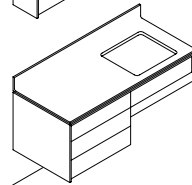

Left:
Exam Room Compact Workstation

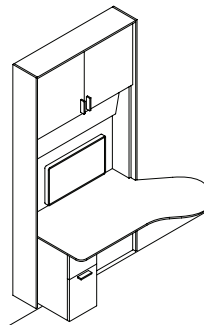

Right:
Desk Arrangement

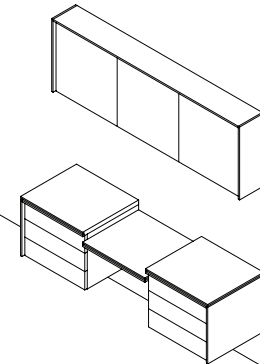

Left:
Dorm Room Desk with Wardrobe

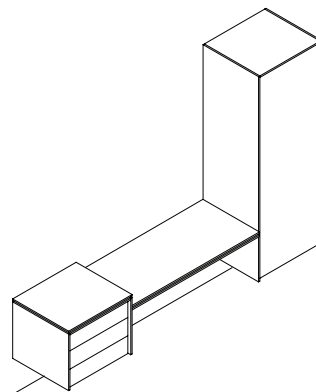

Right:
Conference Room Credenza

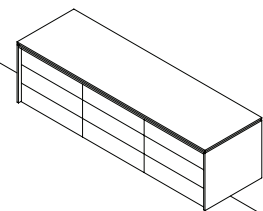

Array Casework - Standard Modules

Overhead Storage

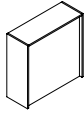

Overhead Storage - Single
GS02-U1

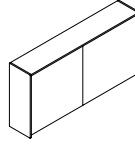

Overhead Storage - Double
GS02-U2

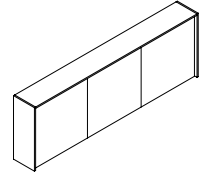

Overhead Storage - Triple
GS02-U3

Drawer Modules

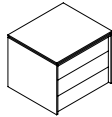

Drawer Module - Single
GS02-D1

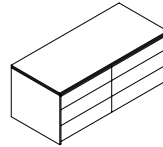

Drawer Module - Double
GS02-D2

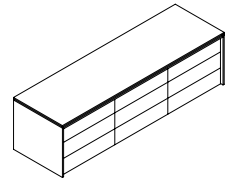

Drawer Module - Triple
GS02-D3

Wardrobes

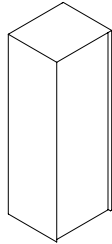

Wardrobe - Basic
GS02-W1

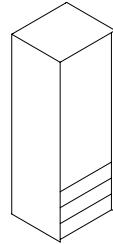

Wardrobe - with Drawers
GS02-W2

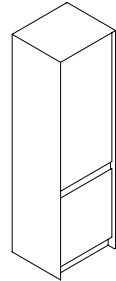

Wardrobe - with Linen Cart
GS02-WF

Lavatories
& Workstation

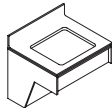

Sink Station - Single
GS02-S1

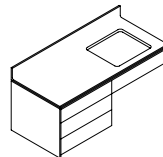

Sink Station - with Drawers
GS02-S2

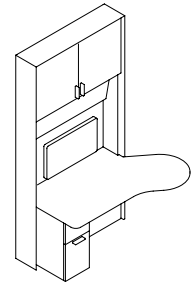

Compact Work Station
GS02-WS

The standards and options listed on this page apply to most but not all Array products.
For step-by-step specifications and quotes, please contact us at quotes@memofurniture.com

Standard Features

- Doors, Drawers, and Facia
- Outer Case Wrap
- Door and Drawer Pulls
- Soft Close Euro Hinge
- Undermount, Soft Close Drawer Slides
- White LPL Case

Standard Options

- Veneer Doors, Drawers, and Facia
- Veneer Wrap
- Glove Dispenser for Overhead Storage
- Paper Towel Dispenser for Overhead Storage
- Extra Adjustable Shelves

Pulls

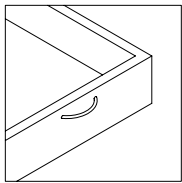

Bow Pull

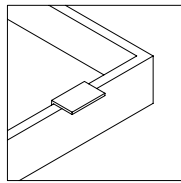

Tab Pull

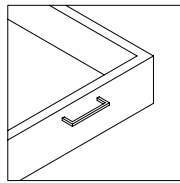

Straight Pull

Wrap Configurations

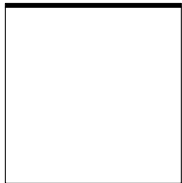

Top Only (standard)

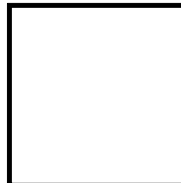

Top + Left

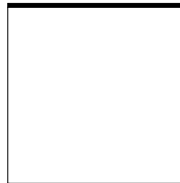

Top + Right

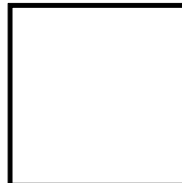

Top + Left + Right

Standard Finishes

- Laminate (HPL) Choose from our open line laminates or request a specific one.
- Solid Surface Choose from Corian or LG Hi-Macs products.
- Veneer Choose from Memo Wood Finishes on page 8.

Notes

- Doors can be specified hinge-right or hinge-left during quote process - for most Array products.
- Case wrap can be specified as full, open left, open right, or open both sides - for most Array products.
- All pulls standard in Brushed Nickel.

Textiles Graded-in Maharam Schedule sorted by Pattern Name

Pattern Name	Pattern No.	Group	Pattern Name	Pattern No.	Group
A Band Apart	466000	15	Bright Cube	466329	10
Abacus	466118	8	Bright Grid	466330	10
Abacus Standard	466140	6	Brim	466350	9
Across	465964	8	Brindle	466418	5
Agency	466001	15	Brio	466386	7
Akimbo	464770	8	Buffer	466492	6
Albemarle	466435	11	Bureau	466472	4
Alloy	466064	7	Bushel	466490	7
Alpaca Epingle	465902	15	Candid	463720	6
Alpaca Velvet	465901	15	Candor	466496	6
Alter	464880	6	Canvas by Kvadrat	466185	7
Amulet	466482	11	Caper	466384	5
Anagram	466067	9	Carapace	466261	12
Angles	466477	14	Cartouche	465988	8
Apex	466522	6	Chalet	466324	8
Apt	466392	6	Chance	464010	8
Arabesque	466204	12	Chasm	466404	7
Arcade	466447	9	Chassis	466458	7
Aria	459950	13	Checker	459830	13
Article	458600	2	Checker Split	460290	13
Balustrade	463120	8	Chenille Cord	407808	10
Bander	466442	13	Chime	465350	6
Banister	466263	8	Chock	466219	7
Bar	466227	6	Circles	458310	12
Bar Crypton	466234	7	Circuit	466089	7
Basel by Kvadrat	466214	7	Clamber	466385	8
Bavaria Stripe	466161	14	Clara by Kvadrat	466025	7
Beacon	466405	9	Coach Cloth	458950	13
Beam	466119	8	Coast	466439	6
Beside	464020	7	Coda by Kvadrat	464480	11
Bespoke Stripe	463540	14	Coin	466233	6
Bevel	466131	6	Coin Crypton	466236	7
Big Stripe	466174	14	Coincide	465808	5
Bind	466437	11	Coincide High Performance	466132	7
Bitmap	466066	6	Colline by Kvadrat	466155	8
Blended Stripe	466412	14	Colorwheel	466163	10
Blip	466129	8	Column	466192	8
Blocks	466209	15	Compartment	466154	15
Bluff	466489	6	Compound	466196	7
Blumen	462870	12	Conduit	466428	5
Boundary	466193	6	Confetti	466203	11
Bright Angle	466331	10	Cotton Velvet	466199	13

Textiles Graded-in Maharam Schedule sorted by Pattern Name

Pattern Name	Pattern No.	Group	Pattern Name	Pattern No.	Group
Couple	466010	8	Fasten	466053	8
Crew	466149	8	Fathom	466013	6
Croft	466498	14	Feature	466343	7
Crosspatch	458920	12	Festoon	466525	8
Crush	464780	8	Floret	464070	8
Cursive	466335	9	Fluent Crypton	466073	8
Cycle	466275	6	Flurry	466480	11
Dapper	466316	6	Fluted Silk	465982	12
Darning Sampler	466460	10	Flutter	466430	14
Darning Sampler Large	466461	11	Focus	465910	6
Darning Sampler Plaid	466462	12	Fold	466292	8
Dart	464040	8	Foliage	466257	15
Decode	464800	8	Fore	466464	11
Deconstructed Rose	466086	15	Forest Nap by Kvadrat	466367	7
Design 9297	465230	13	Fraction	466137	8
Dingbats	465994	11	Frequency	466504	6
Disc	466221	6	Fruit	466262	11
Ditto	465993	8	Furrow	466379	7
Divide	466220	6	Galaxy by Kvadrat	466306	8
Divide Crypton	466238	7	Gallant	466485	6
Divina by Kvadrat	460730	9	Garden	466134	10
Divina MD by Kvadrat	466150	9	Geometri	459970	13
Divina Melange by Kvadrat	460830	9	Gild	466432	7
Dot Pattern	458300	12	Glaze	466506	12
Dots	466411	12	Glid	466432	6
Double Triangles	459840	13	Glow	466500	6
Drape	466145	8	Grade	466260	9
Dwell	466419	3	Grid	466210	15
Eden	466258	15	Grove	466344	7
Edges	466476	12	Gust	466519	6
Ellipsis	466334	7	Hallingdal by Kvadrat	460760	10
Embed	466457	7	Hedge	466298	7
Emboss	466281	8	Hero by Kvadrat	466318	7
Emit	466378	6	Herringbone Stripe	465945	14
Enmesh	466338	6	Hewn	466398	10
Entwine	466397	10	Houndstooth	466253	11
Epingle Stripe	466007	14	Huddle	466420	14
Equate	466383	7	Idle	466466	12
Etch	466502	11	Imbue	466375	10
Exaggerated Plaid	466039	13	Industry	466255	15
Exchange	466027	6	Inlay	466353	11
Facets	459850	13	Insignia	466308	9

Textiles Graded-in Maharam Schedule sorted by Pattern Name

Pattern Name	Pattern No.	Group	Pattern Name	Pattern No.	Group
Instill	466351	6	Mimic	466136	9
Jacobs Coat	462270	14	Mineral	466232	7
Joist	466403	10	Mingled Plaid	466364	14
Keen	466433	6	Minicheck	466268	13
Kindred	466166	7	Mister	466178	9
Knob	466250	14	Mode	466337	2
Knot	466248	12	Mohair Supreme	451801	14
Lariat	440401	1	Molly by Kvadrat	465640	8
Layers Garden	465916	14	Monk's Wool	457301	14
Layers Park	465918	14	Monsoon	466481	10
Layers Vineyard Large	465921	14	Motley	466360	6
Layers Vineyard Small	465920	14	Multiply	466341	5
Lean	466438	6	Murmur	466446	2
Ledger	463770	6	Muse	466487	1
Lens	466323	6	Names	462510	13
Letters	462560	13	Nestle	466388	12
Lift	466302	9	Nimble	466488	7
Limn	466407	10	Oblique	466222	5
Lineage	466127	6	Octave	466116	9
Link	466328	9	Offset	465951	10
Lithe	466394	7	Optik	459960	13
Loop	466469	6	Orakelblume	463900	13
Lunar	466356	5	Orbit	466415	5
Manner	466177	1	Ottoman Stripe	466142	14
Mantle	466517	5	Overlapping Stripe	466495	12
Marquee	463890	5	Painted Stripe	465998	13
Massive Paisley	465915	15	Palio	466107	12
Mechanism	465952	10	Parched Silk	465974	13
Medium	463490	2	Pare	466359	7
Mela	466483	13	Parquet	466376	9
Melange Tweed	461190	13	Paseel	466470	14
Meld	466387	1	Paver	466111	8
Memory by Kvadrat	466211	9	Pebble Wool	457401	14
Meridian	464710	7	Pebble Wool Multi	461200	14
Merit	466444	2	Pennant	466094	8
Mesh	466371	10	Pepper	466486	6
Messenger	458640	1	Periphery	465900	13
Metric	466014	1	Pick	466224	5
Micro	466099	6	Pick Crypton	466235	7
Mikado	459330	12	Pinnacle	466503	7
Milestone	403901	4	Pitch	466186	6
Millerstripe	462250	14	Plait	466052	6

Textiles Graded-in Maharam Schedule sorted by Pattern Name

Pattern Name	Pattern No.	Group	Pattern Name	Pattern No.	Group
Plume	466382	12	Shadow	466521	7
Ply Mesh Black/Tan	465020	13	Sheen	466246	7
Pocket	466243	8	Shuttle Standard	466168	6
Point	466090	13	Sift	466479	11
Pressed Linen	466380	14	Signal	466342	7
Pressed Plaid	466181	14	Silk Canvas	465985	12
Prime	466436	8	Skein	466170	6
Prompt	466493	6	Slant	466358	7
Quatrefoil	459340	12	Slumber	466365	12
Quay	466390	7	Small Dot Pattern	458320	12
Quell	466366	13	Soft Tweed	466197	11
Queue	466443	6	Sort	466273	6
Quick	465850	6	Span	466395	7
Raas	466471	8	Spare	466465	11
Re-Wool by Kvadrat	466499	5	Splay	466448	6
Recheck by Kvadrat	466423	8	Spry	466414	6
Reef	466332	11	Stack	465990	6
Reel	466065	10	Stature	466180	6
Regatta	466189	9	Steady	465947	6
Relay	466453	11	Steady Crypton	465946	8
Remix by Kvadrat	465956	7	Steelcut by Kvadrat	464470	9
Repeat Classic Stripe	462170	14	Steelcut Trio by Kvadrat	465906	9
Repeat Dot Ring	462150	14	Stick Tree by Kvadrat	466368	9
Rill	466370	6	Stride	466252	7
Ring	466182	7	Stripes	463980	14
Roster	466445	4	Strum	466122	7
Rove	466096	5	Study	466269	10
Rule	466190	9	Sudden	463000	8
Runner	466108	8	Sundry	466441	10
Runner Standard	466167	6	Superweave	466241	15
Salon	458670	11	Surge	466314	7
Scape	466357	9	Swathe	466416	10
Scape	466357	9	Switch	466515	7
Schema	466336	7	Swivel	466374	8
Scuba	464930	6	Tally	465989	8
Scute	466396	6	Tandem	466321	6
Scuttle	466429	6	Tangram	466084	11
Segmented Stripe	466373	11	Taper	466413	10
Sequence	466179	7	Teatro	466309	10
Sequential Stripe	466377	14	Technic	466226	5
Serif	466389	9	Telary	466151	10
Serried	466408	8	Tempera	466426	8

Textiles Graded-in Maharam Schedule sorted by Pattern Name

Pattern Name	Pattern No.	Group
Tend	466352	7
Terrace	466114	7
The Firm	465999	15
The Story of My Life	464670	13
Ticker	466304	7
Tilt	466256	8
Tonica by Kvadrat	460850	8
Tonus by Kvadrat	460800	9
Toostripe	462260	14
Tracery	466372	10
Trait	464830	7
Transport	466176	12
Treat	464510	8
Trees	466195	11
Trellis	466244	8
Tress	466529	13
Trio	466088	10
Trundle	466434	5
Twice	465909	6
Twill Weave by Kvadrat	466474	9
Unisol	461160	13
Urban	466079	8
Valor	466491	11
Vases	466164	10
Veer	466497	6
Velvet Stripe	466279	14
Venn	464360	8
Vestige	466259	8
Vineyard	466133	10
Voyage	456801	12
Waterborn by Kvadrat	466097	13
Waver	466459	7
Wedge	466272	8
Wend	466381	6
Wool Rib	466198	11
Wool Striae	466184	14
Wool Velvet	466120	14
Wrap	466231	6

Textiles Graded-in Maharam Schedule sorted by Grading Group

Group & Price/yd	Pattern Name	Number	Group & Price/yd	Pattern Name	Number
Group 1: 44 List	Lariat	440401	Group 2: 56 List	Bitmap	466066
	Manner	466177		Bluff	466489
	Meld	466387		Boundary	466193
	Messenger	458640		Buffer	466492
	Metric	466014		Candid	463720
	Muse	466487		Candor	466496
Group 2: 56 List	Article	458600		Chime	465350
	Medium	463490		Coast	466439
	Merit	466444		Coin	466233
	Mode	466337		Cycle	466275
	Murmur	466446		Dapper	466316
Group 3: 69 List	Dwell	466419		Disc	466221
				Divide	466220
Group 4: 81 List	Bureau	466472		Emit	466378
				Milestone	403901
				Roster	466445
Group 5: 94	Brindle	466418	Enmesh	466338	
			Caper	466384	
			Coincide	465808	
			Conduit	466428	
			Lunar	466356	
			Mantle	466517	
			Marquee	463890	
			Multiply	466341	
			Oblique	466222	
			Orbit	466415	
			Pick	466224	
			Re-Wool by Kvadrat	466499	
			Rove	466096	
			Technic	466226	
			Trundle	466434	
			Group 6: 113 List	Abacus Standard	466140
Alter	464880				
Apex	466522				
Apt	466392				
Bar	466227				
Bevel	466131				
Fathom	466013				
Focus	465910				
Frequency	466504				
Gallant	466485				
Group 7: 124 List	Glid	466432	Glow	466500	
			Gust	466519	
			Instill	466351	
			Keen	466433	
			Lean	466438	
			Ledger	463770	
			Lens	466323	
			Lineage	466127	
			Loop	466469	
			Micro	466099	
			Motley	466360	
			Pepper	466486	
Group 8: 135 List	Pitch	466186	Pitch	466186	
			Plait	466052	
			Prompt	466493	
			Queue	466443	
			Quick	465850	
			Rill	466370	
			Runner Standard	466167	
			Scuba	464930	
			Scute	466396	

Textiles Graded-in Maharam Schedule sorted by Grading Group

Group & Price/yard	Pattern Name	Number	Group & Price/yard	Pattern Name	Number
	Scuttle	466429		Lithe	466394
	Shuttle Standard	466168		Meridian	464710
	Skein	466170		Mineral	466232
	Sort	466273		Nimble	466488
	Splay	466448		Pare	466359
	Spry	466414		Pick Crypton	466235
	Stack	465990		Pinnacle	466503
	Stature	466180		Quay	466390
	Steady	465947		Remix by Kvadrat	465956
	Tandem	466321		Ring	466182
	Twice	465909		Schema	466336
	Veer	466497		Sequence	466179
	Wend	466381		Shadow	466521
	Wrap	466231		Sheen	466246
				Signal	466342
				Slant	466358
				Span	466395
				Stride	466252
				Strum	466122
				Surge	466314
				Switch	466515
				Tend	466352
				Terrace	466114
				Ticker	466304
				Trait	464830
				Waver	466459
Group 7: 138 List	Alloy	466064			
	Bar Crypton	466234			
	Basel by Kvadrat	466214			
	Beside	464020			
	Brio	466386			
	Bushel	466490			
	Canvas by Kvadrat	466185			
	Chasm	466404			
	Chassis	466458			
	Chock	466219			
	Circuit	466089			
	Clara by Kvadrat	466025			
	Coin Crypton	466236			
	Coincide High Performance	466132			
	Compound	466196			
	Divide Crypton	466238			
	Ellipsis	466334			
	Embed	466457			
	Equate	466383			
	Feature	466343			
	Forest Nap by Kvadrat	466367			
	Furrow	466379			
	Gild	466432			
	Grove	466344			
	Hedge	466298			
	Hero by Kvadrat	466318			
	Kindred	466166			
			Group 8: 163 List		
				Abacus	466118
				Across	465964
				Akimbo	464770
				Balustrade	463120
				Banister	466263
				Beam	466119
				Blip	466129
				Cartouche	465988
				Chalet	466324
				Chance	464010
				Clamber	466385
				Colline by Kvadrat	466155
				Column	466192
				Couple	466010
				Crew	466149

Textiles Graded-in Maharam Schedule sorted by Grading Group

Group & Price/yard	Pattern Name	Number	Group & Price/yard	Pattern Name	Number
	Crush	464780		Divina MD by Kvadrat	466150
	Dart	464040		Divina Melange by Kvadrat	460830
	Decode	464800		Grade	466260
	Ditto	465993		Insignia	466308
	Drape	466145		Lift	466302
	Emboss	466281		Link	466328
	Fasten	466053		Memory by Kvadrat	466211
	Festoon	466525		Mimic	466136
	Floret	464070		Mister	466178
	Fluent Crypton	466073		Octave	466116
	Fold	466292		Parquet	466376
	Fraction	466137		Regatta	466189
	Galaxy by Kvadrat	466306		Rule	466190
	Molly by Kvadrat	465640		Scape	466357
	Paver	466111		Scape	466357
	Pennant	466094		Serif	466389
	Pocket	466243		Steelcut by Kvadrat	464470
	Prime	466436		Steelcut Trio by Kvadrat	465906
	Raas	466471		Stick Tree by Kvadrat	466368
	Recheck by Kvadrat	466423		Tonus by Kvadrat	460800
	Runner	466108		Twill Weave by Kvadrat	466474
	Serried	466408			
	Steady Crypton	465946	Group 10: 219 List	Bright Angle	466331
	Sudden	463000		Bright Cube	466329
	Swivel	466374		Bright Grid	466330
	Tally	465989		Chenille Cord	407808
	Tempera	466426		Colorwheel	466163
	Tilt	466256		Darning Sampler	466460
	Tonica by Kvadrat	460850		Entwine	466397
	Treat	464510		Garden	466134
	Trellis	466244		Hallingdal by Kvadrat	460760
	Urban	466079		Hewn	466398
	Venn	464360		Imbue	466375
	Vestige	466259		Joist	466403
	Wedge	466272		Limn	466407
				Mechanism	465952
Group 9: 188 List	Anagram	466067		Mesh	466371
	Arcade	466447		Monsoon	466481
	Beacon	466405		Offset	465951
	Brim	466350		Reel	466065
	Cursive	466335		Study	466269
	Divina by Kvadrat	460730		Sundry	466441

Textiles Graded-in Maharam Schedule sorted by Grading Group

Group & Price/yard	Pattern Name	Number	Group & Price/yard	Pattern Name	Number
	Swathe	466416		Edges	466476
	Taper	466413		Fluted Silk	465982
	Teatro	466309		Glaze	466506
	Telary	466151		Idle	466466
	Tracery	466372		Knot	466248
	Trio	466088		Mikado	459330
	Vases	466164		Nestle	466388
	Vineyard	466133		Overlapping Stripe	466495
				Palio	466107
				Plume	466382
Group 11: 256 List	Albemarle	466435		Quatrefoil	459340
	Amulet	466482		Silk Canvas	465985
	Bind	466437		Slumber	466365
	Coda by Kvadrat	464480		Small Dot Pattern	458320
	Confetti	466203		Transport	466176
	Darning Sampler Large	466461		Voyage	456801
	Dingbats	465994			
	Etch	466502			
	Flurry	466480	Group 13: 375 List	Aria	459950
	Fore	466464		Bander	466442
	Fruit	466262		Checker	459830
	Houndstooth	466253		Checker Split	460290
	Inlay	466353		Coach Cloth	458950
	Reef	466332		Cotton Velvet	466199
	Relay	466453		Design 9297	465230
	Salon	458670		Double Triangles	459840
	Segmented Stripe	466373		Exaggerated Plaid	466039
	Sift	466479		Facets	459850
	Soft Tweed	466197		Geometri	459970
	Spare	466465		Letters	462560
	Tangram	466084		Mela	466483
	Trees	466195		Melange Tweed	461190
	Valor	466491		Minicheck	466268
	Wool Rib	466198		Names	462510
				Optik	459960
Group 12: 294 List	Arabesque	466204		Orakelblume	463900
	Blumen	462870		Painted Stripe	465998
	Carapace	466261		Parched Silk	465974
	Circles	458310		Periphery	465900
	Crosspatch	458920		Ply Mesh Black/Tan	465020
	Darning Sampler Plaid	466462		Point	466090
	Dot Pattern	458300		Quell	466366
	Dots	466411		The Story of My Life	464670
				Tress	466529

Textiles Graded-in Maharam Schedule sorted by Grading Group

Group & Price/yard	Pattern Name	Number	Group & Price/yard	Pattern Name	Number
	Unisol	461160		Blocks	466209
	Waterborn by Kvadrat	466097		Compartment	466154
Group 14: 438 List	Angles	466477		Deconstructed Rose	466086
	Bavaria Stripe	466161		Eden	466258
	Bespoke Stripe	463540		Foliage	466257
	Big Stripe	466174		Grid	466210
	Blended Stripe	466412		Industry	466255
	Croft	466498		Massive Paisley	465915
	Epingle Stripe	466007		Superweave	466241
	Flutter	466430		The Firm	465999
	Herringbone Stripe	465945			
	Huddle	466420			
	Jacobs Coat	462270			
	Knob	466250			
	Layers Garden	465916			
	Layers Park	465918			
	Layers Vineyard Large	465921			
	Layers Vineyard Small	465920			
	Millerstripe	462250			
	Mingled Plaid	466364			
	Mohair Supreme	451801			
	Monk's Wool	457301			
	Ottoman Stripe	466142			
	Paseel	466470			
	Pebble Wool	457401			
	Pebble Wool Multi	461200			
	Pressed Linen	466380			
	Pressed Plaid	466181			
	Repeat Classic Stripe	462170			
	Repeat Dot Ring	462150			
	Sequential Stripe	466377			
	Stripes	463980			
	Toostripe	462260			
	Velvet Stripe	466279			
	Wool Striae	466184			
	Wool Velvet	466120			
Group 15: 563 List	A Band Apart	466000			
	Agency	466001			
	Alpaca Epingle	465902			
	Alpaca Velvet	465901			

Corian Solid Surface Schedule sorted by Grading Group

Group 1	Abalone	Deep Caviar	Whipped Cream	Minera
	*Bisque	Deep Mink	Willow	Nimbus Prima
	*Bone	Deep Night Sky		Sagebrush
	*Cameo White	Dove	Group 6	Sand Storm
	*Glacier White	Flint	Arrowroot	Smoke Drift Prima
	Linen	Fossil	Basil	Sonora
	Maui	Granola	Clam Shell	Stardust
	Sahara	Pine	Cool Gray	White Onyx
	Sandstone	Raffia	Cosmos Prima	Windswept Prima
	Silver Gray	Rice Paper	Earth	
	Vanilla	Royal Red	Gray Onyx	
		Seafoam	Hazelnut	
Group 2	Antarctica	Serene Sage	Jasmine	
	Aurora	Suede	Keystone	
	Blue Pebble	Venaro White	Lava Rock	
	Canyon	Whisper	Limestone Prima	
	Cocoa Brown	White Jasmine	Natural Gray	
	Designer White		Rain Cloud	
	Modern White	Group 5	Riverbed	
	Mojave	Anthracite	Rosemary	
	Sand	Ash Concrete	Saffron	
	Savannah	Blue Spice	Sandalwood	
	Stratus	Carbon Concrete	Sorrel	
	Summit White	Cilantro	Tumbleweed	
		Deep Anthracite	Witch Hazel	
		Deep Bedrock		
Group 3	Elegant Gray	Deep Cloud	Group 7	Allspice
	Everest	Deep Espresso	Aqualite	
	Moss	Deep Nocturne	Burled Beach	
	Nightfall	Deep Sable	Cocoa Prima	
	Pearl Gray	Deep Space	Deep Inkwell	
	Platinum	Deep Storm	Deep Lapis	
	Silt	Deep Titanium	Deep Smoky Pear	
	Sparkling White	Doeskin	Deep Terrain	
		Fawn	Dune Prima	
Group 4	Arctic Ice	Glacier Ice	Ecrú	
	Bronzite	Matterhorn	Elderberry	
	Canvas	Neutral Concrete	Evening Prima	
	Cobalt	Oat	Graylite	
	Concrete	Silver Birch	Hickory Smoke	
	Cottage Lane	Silverite	Juniper	
	Deep Black Quartz	Weathered Concrete	Milky Way	

*Only these finishes are currently available for Sink Stations (GS02-S1 & GS02-S2)

Standard Linoleum Schedule**Forbo Furniture Linoleum**

Aquavert	4180
Ash	4132
Burgundy	4154
Charcoal	4166
Conifer	4174
Iron	4178
Mauve	4172
Midnight Blue	4181
Mushroom	4176
Nero	4023
Olive	4184
Orange Blast	4186
Pearl	4157
Pebble	4175
Pewter	4155
Pistachio	4183
Powder	4185
Salsa	4164
Smokey Blue	4179
Spring Green	4182
Vapour	4177

Leather Arm Wrap Colors for Chroma Lounge

Select [Maharam Pace](#) colors

Shy	L002
Granite	L003
Proper	L007
Darkroom	L009
Rodeo	L027
Desert	L032

memo

Memo Furniture
+1 206 995 8780
memofurniture.com