

Pricelist
2021 / Q4

memo

Contents

page 3 Terms of Sale
page 4 Limited Lifetime Warranty
page 5 Customer Service
page 6 Finishes Overview
page 8 Textiles Overview

page 12 Chord Tables

page 12 Personal Table
page 14 Side Table
page 16 Coffee Table

page 18 Chroma Seating

page 18 Lounge
page 20 Lounge Armless
page 22 Lounge Swivel
page 24 Ottoman

page 25 Kino

page 25 Kino

page 27 Maru Benches

page 27 Three Slat Bench, 3/4 Length
page 30 Three Slat Bench
page 33 Five Slat Bench
page 37 Seven Slat Bench

page 40 Penna Seating

page 40 Lounge

page 42 Penna Tables

page 42 Large Round
page 43 Obround
page 44 Small Round
page 45 Bar Table
page 47 Café Table
page 49 Meeting Table

page 51 Prose Seating

page 51 Side Chair with Arms
page 53 Plus Chair
page 55 Settee
Prose Seating Continued...

page 57 Pull-Up Chair

page 59 Lounge

page 61 Loveseat

page 63 Prose Tables

page 63 Free-Standing End Table
page 64 Free-Standing Coffee Table

page 65 Rolo Seating

page 65 Lounge
page 67 Loveseat
page 69 Sofa

page 71 Rolo Tables

page 71 Side Table
page 72 Coffee Table

page 73 Materials & Finishes Schedules

page 73 Textiles Schedule
page 85 Corian Solid Surface Schedule
page 86 Leather Arm Wrap Colors for Chroma

Terms of Sale

Pricing Policy

All prices shown for products and accessories are manufacturer's suggested list price. Prices shown do not include appropriate taxes, crating (if applicable), storage and installation charges. Memo reserves the right to amend price lists, change designs, and discontinue or add models without prior notice. Price list of latest date supersedes and cancels all previous lists. All orders accepted are subject to prices upon receipt of order.

Payment Terms

Except as otherwise specified, all orders require a 50% deposit with the balance due with thirty (30) days from the invoice date. All payments are payable in U.S. dollars. Lead times start after the receipt of deposit. Payments not made by the due date may incur, at the sole discretion of Memo, a late payment service charge of 1.5% per month. All payments and deposits are non-refundable.

Changes and Cancellations

Customers will receive a written confirmation of pricing, credit terms and estimated completion date. Changes to orders or cancellations made after production has begun will carry extra charges based on expenses incurred.

Shipping

Memo list prices include standard cartoning and standard surface freight to any point within the 48 contiguous United States. For shipments to Alaska, Hawaii and International destinations, additional shipping and handling charges will apply. Additional freight charges will be provided at the time of quote. Orders are shipped cartoned as standard. If crating is requested or required, additional charges will apply. For a schedule of crating charges, please consult page 06 of this pricelist.

Freight Claims

Product is shipped FOB Factory, freight prepaid and allowed via truck. The title of goods changes to the purchaser when merchandise leaves Memo's dock and any subsequent freight damage and all freight claims are the responsibility of the purchaser. All shipments are transferred to the transportation company in good condition.

Purchaser should inspect cartons and product upon receipt and note the condition and any damage or shortage on the Bill of Lading. The purchaser should file all claims of evident damage or product shortages with the freight company and request an inspection. Shipping cartons and packaging should be retained for carrier inspection and the damaged product should be kept in the receiving location. If the freight carrier will not perform the inspection, purchaser should prepare an affidavit; noting that the freight company refused to comply with an inspection - citing date and time.

Any concealed damage claims against Memo for apparent damages must be made by the purchaser in writing within seven (7) business days after delivery. Failure to do so shall constitute acceptance of the product and waiver of any apparent damages. Any relevant damage or shortages to blanket wrapped shipments must be noted on the Bill of Lading at the time of delivery.

Custom Requests

Requests to modify existing products (Modifications) or to produce ground-up solutions (Specials) should be submitted to our customer service group, at which time they will be assessed and submitted for design and engineering approval. All custom requests will elicit a receipt and a response will be provided within 48 hours of receipt. Upon approval, a price and lead-time quote will be generated and provided for customer review and acceptance.

Limited Lifetime Warranty

Memo Furniture warrants its products, to the original user and for the original purpose, to be free of defects in design, material and workmanship, given normal use and care for the lifetime of the product from the date of invoice. This warranty does not include damage from accident, alteration, misuse, normal wear and tear, transportation or improper installation and maintenance.

During the warranty period, Memo Furniture, at its option, will repair or replace any product which, upon inspection by Memo Furniture or its designated representative, is deemed to be defective in materials or workmanship and is covered by this warranty.

This warranty does not apply to defects in components not manufactured by Memo Furniture. In these cases, the warranty period provided by the supplier of the component will apply. The liability of Memo Furniture is limited to furnishing new parts as may be necessary to replace any item that may prove to be defective in material or workmanship. Memo Furniture will make every effort to replace parts if they are available from the supplier of those parts. We will not assume liability of charges for labor, consequential expenses or damages incurred.

Textiles and leathers are not warranted against fading or normal wear, customer induced cuts or tears or irregularities in the registration of printed textile patterns. Due to natural variations, in which Memo Furniture has no control, this warranty does not extend to color, grain, texture or the durability or suitability of any exterior surface coatings or treatments.

This warranty is void in cases of damage in transit, negligence, abuse, abnormal usage, misuse, accidents, and improper cleaning and maintenance. Normal aging and wear of woven and non-woven upholstery are exempt from this warranty.

All other warranties, expressed or implied, are excluded. Memo Furniture shall not be liable for incidental or consequential damages of any sort.

If you have any questions or wish to file a claim against this warranty, please contact Customer Service at +1 206 995 8780.

Customer Service

Memo's Customer Service Group is trained to assist with quotes, orders, custom requests, product details, warranty inquires, and to answer general questions.

We can be reached Monday through Friday, 7:00 am – 5:00 pm Pacific Time, directly at +1 206 995 8780 or via email at info@memofurniture.com.

Inquiries received after-hours via voicemail or email will receive a response before the close of business on the following business day.

Please visit www.memofurniture.com for answers to most questions including product prices, specifications, photos, SketchUp and Revit files, and marketing material. Additionally, a local sales representative can assist you further. Contact names and numbers are also available on our website.

Finishes

Memo offers a range of proprietary colors and finishes on select materials, as well as support for a broad range of open line laminates and Corian solid surface. Our finishes have been curated to offer a foundation of essential base neutrals, to which accents and stronger colors can be added.

Memo offers finish and pattern selections in the following materials:

Forbo Furniture Linoleum

Memo offers Forbo furniture-grade linoleum on select products. Forbo is a durable surface material, available in a dynamic range of colors. Derived from solidified Linseed Oil and other natural fillers such as cork and wood dust, Forbo is a sustainable and resilient surface choice.

Metal Powder Coat

Our powder coats are applied to both steel and aluminum, and are available in textured and smooth finishes. Powder coating is extremely durable and emits zero pollutants once cured.

Natural Stone and Quartz

Memo offers natural stone and quartz on select table and horizontal surface tops. Our stone is hand selected from the highest quality slabs however natural variances will occur from product to product.

Solid Surface

Memo offers all Corian solid surface on most applicable products. Corian, is a non-porous high durability product that is stain resistant, easy to clean, and easily repairable.

Stainless Steel

Select products offer stainless steel as an alternate to Powder Coated Metal. Our stainless is 200 series, treated with a #4 brushed surface finish.

Wood & Veneer

Our products utilize both solid wood and wood veneer, and are offered in either Ash or Walnut. Products with edge profiles will include a matching wood edge. Wood products are finished in a resilient, long lasting, conversion varnish.

Memo Colors and Finishes

Metal Powder Coat

Light Gray Texture	MLG
Steel Gray Gloss	MSG
Med Bronze Gloss	MMB
Black Texture	MBT
Silver Metallic Gloss	MSM
Yellow Leaf Gloss	MYL
Copper Red Matte	MCR
Sage Green Matte	MGG
Navy Blue Matte	MNB

Natural Stone

White Gray Marble	RWM
-------------------	-----

Quartz

Valente Pearl Quartz	RVQ
Concrete Gray Quartz	RCQ
Onyx Carrara Quartz	ROQ

Stainless Steel

Brushed Stainless Steel	MSS
-------------------------	-----

Wood & Veneer

Clear over Ash	WCA
Oak Over Ash	WOA
Gray Over Ash	WGA
Walnut Over Ash	WWA
Clear Over Beech	WCB
Clear Over Walnut	WCW
Navy Painted Wood	WNP

Forbo Furniture Linoleum

Aquavert - 4180	FAQ
Ash - 4132	FAS
Burgundy - 4154	FBU
Charcoal - 4166	FCH
Iron - 4178	FIR
Midnight Blue - 4181	FMB
Mushroom - 4176	FMU
Olive - 4184	FOL
Pebble - 4175	FPE
Pewter - 4155	FPW
Powder - 4185	FPO
Salsa - 4164	FSA
Smokey Blue - 4179	FSB
Vapour - 4177	FVA

Memo Supported Open-Line Finishes

Corian - Solid Surface

Memo offers all Corian solid surface on most applicable products. For a list of Corian products by grade see page 59.

Textiles

Graded-in Textiles

Memo has partnered with Maharam and Kvadrat to offer graded-in textiles. All graded-in textiles are listed by Pattern Name on page 76 and by Grading Group on page 81. Our Grading Groups and their LIST prices per yard are outlined below. Published product prices, including the cost of Graded-in Textiles, have been calculated by multiplying by the price per yard figures below by the yardage requirements indicated on a given product page.

Grading Group	LIST Price per Yard
1	52
2	65
3	81
4	92
5	106
6	119
7	138
8	163
9	188
10	219
11	256
12	294
13	375
14	438
15	563

Memo is glad to grade in textiles from suppliers other than Maharam and Kvadrat, per customer requests. Please contact us to submit grading requests.

When specifying graded-in textiles the projected completion date of your order may exceed our normal lead times due to constraints of the textile supplier. In such instances, Memo will promptly communicate such delays and advise on adjusted lead times.

Textiles are subject to the quality and shipping standards of the provider. Memo assumes no responsibility for defects, color inaccuracies, shortages, wear, or performance of textiles.

Ordering a Textile Sample

Samples can be ordered by visiting the textile provider's website.

Textiles

Customer's Own Material (COM)

While we recommend selecting from our graded-in Maharam and Kvadrat textile offer for the most streamlined process, we also provide the option to use COM. Memo, however, reserves the right to reject textiles which are unsuitable for upholstery on our products. This may be due to inadequate textile weight or unique elastic qualities which impact the integrity of upholstery on our products.

To select fabric outside of the graded-in fabric program, a few steps are required. Memo provides the total yardage for each product on its product spec sheets and pricelist reference pages. These published yardage figures are based on the application conditions of the cutting pattern for each product as well as managing quality issues. Certain textiles, depending on their width and/or repeat, may require additional yardage beyond the figures in our pricing pages. To calculate additional yardage, see our guidelines on page 11. Memo will also provide yardage requirements upon receipt of an order.

Upon receipt of the textile, Memo will immediately advise if flaws or deficiencies in the order are discovered. Memo assumes no responsibility for defects, color inaccuracies, shortages, wear, or sub-standard performance of the specified textiles.

Note that Memo will dispose of excess upholstery material at the time of shipment unless expressly requested to return it with the product shipment.

Customer's Own Leather (COL)

Please contact our customer service group at info@memofurniture.com or +1 206 995 8780.

Textiles**Delivery of Customer's Own Material (COM)**

Customers are responsible for ensuring delivery of COM fabric to Memo. Orders for COM-upholstered products will be scheduled into production upon receipt of all COM and swatches. Please work with our customer service group to procure written confirmation of textile supplier ship dates to ensure the best possible lead time. Since shipment of COM orders depends upon textile availability, lead times may vary.

When supplying COM textiles to Memo, please include the following info:

Textile supplier

Pattern name and number

Color name and number

A representative fabric swatch for identification purposes with face side marked

Any nonstandard treatments applied to the fabric

Any additional documentation

All COM or COL must be sent prepaid to the following address and tagged as follows:

C/O Memo Furniture

4660 Colorado Avenue South, Suite A

Seattle, WA 98134

Dealer name

P.O. #

Order code # (for each fabric)

Textiles**Order Requirements for Customer's Own Material (COM)**

Memo reserves the right to reject textiles or materials. Textiles requiring secondary backing or coatings should be treated prior to shipping to Memo. All yardage figures listed in Memo product spec sheets and pricelist reference pages are based on at least 54" Wide, Plain Fabric.

Increases for Textile Width and/or Repeat

In the event that COM textile is both less than 54" wide and also has a repeat, add both of the two increases shown below. For textiles that require matching (stripes, plaids, prints, pattern repeats) it is Memo's policy to match all pattern repeats, stripes, prints or plaids unless specified 'No Matching Required' on purchase order.

Fabric Bolts Less than 54" Wide

Less than 54" wide	Add 08%
Less than 50" wide	Add 13%
Less than 48" wide	Add 20%
Less than 45" wide	Add 50%
Less than 36" wide	Add 60%

Fabrics with Repeats

Repeat 7" & less	Add 11%
Repeat 13" & less	Add 18%
Repeat 21" & less	Add 21%
Repeat 27" & less	Add 24%
Repeat more than 27"	Add 25%

Order Requirements for Customer's Own Leather (COL)

COL orders are based on an average hide size of 45 square feet of usable leather and 19 feet per yard. Due to shape and quality issues with some leather, additional hides may be required after receipt of COL. Ship full hides only.

To convert COM yardage requirements to COL square footage and number of hides, multiply the COM yardage by 19.

Example: 5 yards x 19 = 95 square feet.

Chord

Personal Table

Designed by Standard Issue, 2019

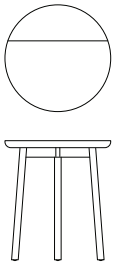

Depth	Width	Height
18"	18"	20.5"

Core Product	Core Code	List Price
Personal Table	MM01-T1	1344

Standard with Core Product

- Glides
- Open Tray Surface
- Powder Coated Steel Frame

Options

	Code	List Price Add
Large Insert Options		
Forbo Linoleum	FTL	304
Wood Veneer (Ash)	VAL	281
Wood Veneer (Walnut)	VWL	281
Small Insert Options		
No Insert (void)	XXS	0
Forbo Linoleum	FTS	57
Wood Veneer (Ash)	VAS	95
Wood Veneer (Walnut)	VWS	95
Quartz	STS	1264

Specifiable Finishes

Linoleum	Choose from Forbo linoleum products on page 7
Metal	Choose from Memo Metal Powder Coat Finishes on page 7
Wood	Choose from Memo Wood Finishes on page 7
Quartz	Choose from Memo Quartz Finishes on page 7

Notes

Pricing includes Freight within Continental US

For step-by-step specifications and quotes, access our live quote tool online at → [Quotes](#)

Chord

Side Table

Designed by Standard Issue, 2019

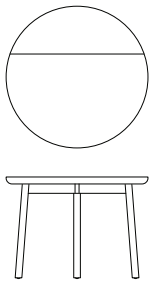

Depth	Width	Height
24"	24"	17.25"

Core Product	Core Code	List Price
Side Table	MM01-T2	1474

Standard with Core Product

- Glides
- Open Tray Surface
- Powder Coated Steel Frame

Options

	Code	List Price Add
Large Insert Options		
Forbo Linoleum	FTL	354
Wood Veneer (Ash)	VAL	351
Wood Veneer (Walnut)	VWL	351
Small Insert Options		
No Insert (void)	XXS	0
Forbo Linoleum	FTS	58
Wood Veneer (Ash)	VAS	98
Wood Veneer (Walnut)	VWS	98
Quartz	STS	1358

Specifiable Finishes

Linoleum	Choose from Forbo linoleum products on page 7
Metal	Choose from Memo Metal Powder Coat Finishes on page 7
Wood	Choose from Memo Wood Finishes on page 7
Quartz	Choose from Memo Quartz Finishes on page 7

Notes

Pricing includes Freight within Continental US

For step-by-step specifications and quotes, access our live quote tool online at → [Quotes](#)

Chord

Coffee Table

Designed by Standard Issue, 2019

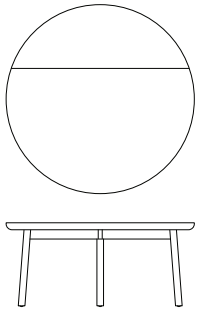

Depth	Width	Height
32"	32"	14.25"

Core Product	Core Code	List Price
Coffee Table	MM01-T3	1690

Standard with Core Product

- Glides
- Open Tray Surface
- Powder Coated Steel Frame

Options

	Code	List Price Add
Large Insert Options		
Forbo Linoleum	FTL	445
Wood Veneer (Ash)	VAL	461
Wood Veneer (Walnut)	VWL	461
Small Insert Options		
No Insert (void)	XXS	0
Forbo Linoleum	FTS	71
Wood Veneer (Ash)	VAS	106
Wood Veneer (Walnut)	VWS	106
Quartz	STS	1381

Specifiable Finishes

Linoleum	Choose from Forbo linoleum products on page 7
Metal	Choose from Memo Metal Powder Coat Finishes on page 7
Wood	Choose from Memo Wood Finishes on page 7
Quartz	Choose from Memo Quartz Finishes on page 7

Notes

Pricing includes Freight within Continental US

For step-by-step specifications and quotes, access our live quote tool online at → [Quotes](#)

Chroma

Lounge

Designed by Harri Koskinen, 2019

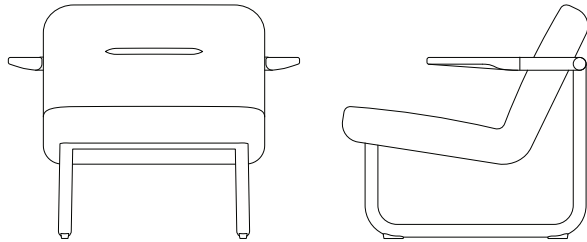

Depth	Width	Height
28.75"	33.75"	27.5"

Core Product

Lounge

Core Code

HK01-01

Textile Yardage

Total: 2.0

Seat Back Arms

n/a n/a n/a

List Price by Textile Grade

	COM	1	2	3	4	5	6	7	8	9	10	11	12	13	14	15
HK01-01	3223	3327	3353	3385	3407	3435	3461	3499	3549	3599	3661	3735	3811	3973	4099	4349

Standard with Core Product

Ash Arms

Non-Marring Glides

High Resilience Polyurethane Foam

Options and Notes overleaf

Options

Component	Code	List Price Add
Walnut Arms	WCW	175

Specifiable Finishes

- Metal Choose from Memo Metal Powder Coat Finishes on page 7
- Textiles Choose from Maharam or Kvadrat textiles on page 83, or contact Memo for assistance with COM fabrics
- Wood Choose from Memo Wood Finishes on page 7

Notes

Pricing includes Freight within Continental US
Due to the continuous seat and back, multiple textiles are not permitted on Chroma Lounge
For step-by-step specifications and quotes, access our live quote tool online at → [Quotes](#)

Chroma

Lounge, Armless

Designed by Harri Koskinen, 2019

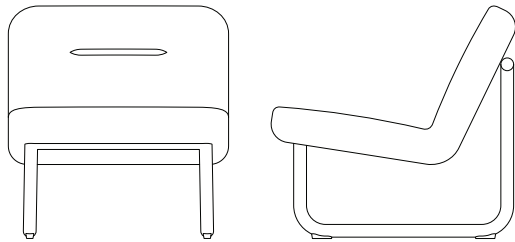

Depth	Width	Height
28.75"	26"	27.5"

Core Product

Lounge, Armless

Core Code

HK01-09

Textile Yardage

Total: 2.0

Seat	Back	Arms
n/a	n/a	n/a

List Price by Textile Grade

	COM	1	2	3	4	5	6	7	8	9	10	11	12	13	14	15
HK01-09	3062	3166	3192	3224	3246	3274	3300	3338	3388	3438	3500	3574	3650	3812	3938	4188

Standard with Core Product

Non-Marring Glides

High Resilience Polyurethane Foam

Options and Notes overleaf

Specifiable Finishes

Metal	Choose from Memo Metal Powder Coat Finishes on page 7
Textiles	Choose from Maharam or Kvadrat textiles on page 83, or contact Memo for assistance with COM fabrics

Notes

Pricing includes Freight within Continental US

Due to the continuous seat and back, multiple textiles are not permitted on Chroma Lounge

For step-by-step specifications and quotes, access our live quote tool online at → [Quotes](#)

Chroma

Lounge, Swivel

Designed by Harri Koskinen, 2019

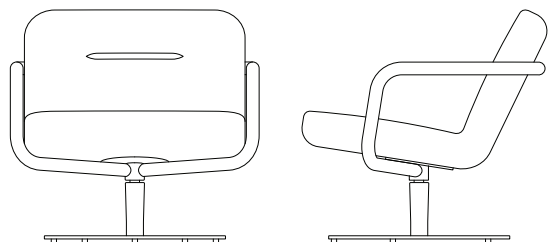

Depth	Width	Height
28.75"	29.25"	27.5"

Core Product

Lounge, Swivel

Core Code

HK01-11

Textile Yardage

Total: 2.0

Seat	Back	Arms
n/a	n/a	n/a

List Price by Textile Grade

	COM	1	2	3	4	5	6	7	8	9	10	11	12	13	14	15
HK01-11	3266	3370	3396	3428	3450	3478	3504	3542	3592	3642	3704	3778	3854	4016	4142	4392

Standard with Core Product

Free swivel base

High Resilience Polyurethane Foam

Non-Marring Glides

Options

Component	Code	List Price Add
Leather Arm Wrap	varies	294

Specifiable Finishes

- Leather Choose from Memo Leather Colors on page 96
- Metal Choose from Memo Metal Powder Coat Finishes on page 7
- Textiles Choose from Maharam or Kvadrat textiles on page 83, or contact Memo for assistance with COM fabrics

Notes

Pricing includes Freight within Continental US
Due to the continuous seat and back, multiple textiles are not permitted on Chroma Lounge
For step-by-step specifications and quotes, access our live quote tool online at → [Quotes](#)

Chroma

Ottoman

Designed by Harri Koskinen, 2019

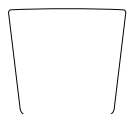
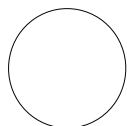

Depth	Width	Height
17.25"	17.25"	15.5"

Core Product

Ottoman

Core Code

HK01-00

Textile Yardage	Seat	Back	Arms
Total: 1.25	1.25	n/a	n/a

List Price by Textile Grade

	COM	1	2	3	4	5	6	7	8	9	10	11	12	13	14	15
HK01-00	898	976	996	1020	1036	1057	1077	1105	1143	1180	1227	1282	1339	1461	1555	1743

Standard with Core Product

High Resilience Polyurethane Foam

Non-Marring Glides

Specifiable Finishes

Textiles Choose from Maharam or Kvadrat textiles on page 83, or contact Memo for assistance with COM fabrics

Notes

Pricing includes Freight within Continental US

For step-by-step specifications and quotes, access our live quote tool online at → Quotes

Kino

Stool

Designed by Kensaku Oshiro, 2020

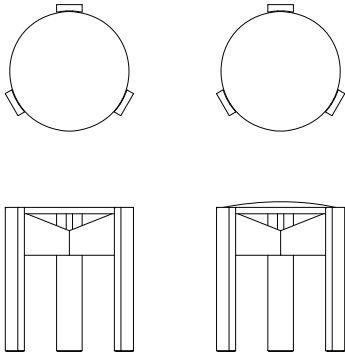

Depth	Width	Height
15.75"	15.75"	17.75 / 18.25"

Core Product	Core Code	List Price
Stool - Ash	KN01-A	752
Stool - Walnut	KN01-W	936

Standard with Core Product

- Glides
- Solid Wood Frame
- Solid Wood Top

Textile Yardage	Seat
Total: .75	.75

List Price by Textile Grade*

	COM	1	2	3	4	5	6	7	8	9	10	11	12	13	14	15
KN01-02-A-UTT	923	962	972	984	992	1003	1012	1027	1045	1064	1087	1115	1144	1204	1252	1345
KN01-02-W-UTT	1067	1106	1116	1128	1136	1147	1156	1171	1189	1208	1231	1259	1288	1348	1396	1489

Standard with Core Product

- Non-Marring Glides
- High Resilience Polyurethane Foam

Options and Notes overleaf

Options

	Code	List Price Add
Upholstered Top	UTT	See previous page
Clear Finish (by species)	WCA/WCW	0
Stain Finish	WOA/WWA	48
Stain Finish	WGA/WNP	87

Specifiable Finishes

- Wood Choose from Memo Wood Finishes on Page 7
- Textiles Choose from Maharam or Kvadrat textiles on page 83, or contact Memo for assistance with COM fabrics

Notes

Pricing includes Freight within Continental US
For step-by-step specifications and quotes, access our live quote tool online at → [Quotes](#)

Maru Benches

Three Slat Bench - 3/4-Length, Indoor
Designed by Studio Gorm, 2020



Depth	Width	Height
17.75"	65.5"	17"

Core Product

Three Slat Bench - 3/4-Length - Beech, Indoor

Core Code

SG03-IND-S3-66W-B

Standard with Core Product

Glides
Solid Beech Wood Frame

Upholstery Configurations

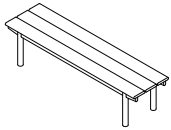

Configuration 1.3-S
(none)

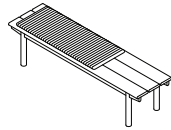

Configuration 2.3-S
-PC2

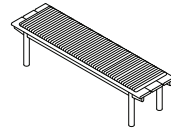

Configuration 3.3-S
-P60D2

Textile Yardage

Pad, Long (60"): 2.50 (each)
Pad, Standard: 1.50 (each)

Upholstery Configurations - List Price by Textile Grade

	COM	1	2	3	4	5	6	7	8	9	10	11	12	13	14	15
Configuration 1.3-S	2120	n/a	n/a	n/a	n/a	n/a	n/a	n/a	n/a	n/a	n/a	n/a	n/a	n/a	n/a	n/a
Configuration 2.3-S	2,745	2,823	2843	2867	2883	2904	2924	2952	2990	3027	3074	3129	3186	3308	3402	3590
Configuration 3.3-S	2800	2930	2963	3003	3030	3065	3098	3145	3208	3270	3348	3440	3535	3738	3895	4208

Options and Notes overleaf

Options

Wood Species	Code	List Price Add
Beech	B	0
Ash	A	380
Walnut	W	2820

Wood Finishes	Code	List Price Add
Clear over Beech/Ash/Walnut	WCB/WCA/WCW	0
Gray over Ash	WGA	236
Oak over Ash	WOA	158
Walnut over Ash	WWA	158
Navy Painted Wood (Ash)	WNP	236

Accessories (see below for visuals)

Table, Round	T1	426
Table, Obround	T2	526
Power Module/s	PM1/PM2	315/899

Other Options

Veneer Table Top(s), Beech	VTB	0
Veneer Table Top(s), Ash	VTA	28
Veneer Table Top(s), Walnut	VTW	30
Forbo Linoleum Table Top(s)	FTT	178

Accessories (visuals)

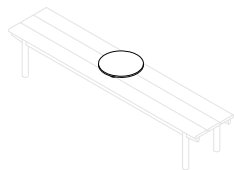

Table, Round
See below for locations

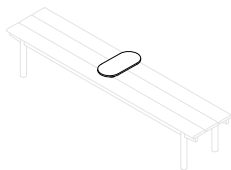

Table, Obround
See below for locations

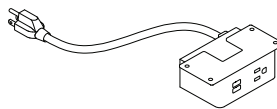

Power Module
1-Power, 2-USB

Table Locations (Round Table shown)

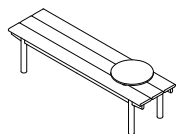

-T1F2
For Configurations 1.3-S

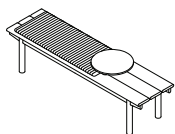

-T1E2
For Configuration 2.3-S

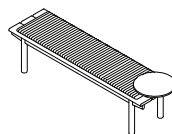

-T1G2
For Configuration 3.3-S

Notes overleaf

Specifiable Finishes

Linoleum	Choose from Forbo linoleum products on page 7
Textiles	Choose from Maharam or Kvadrat textiles on page 83, or contact Memo for assistance with COM fabrics
Wood/Veneer	Choose from Memo Wood Finishes on page 7

Notes

Pricing includes Freight within Continental US

For step-by-step specifications and quotes, access our live quote tool online at → [Quotes](#)

Maru Benches

Three Slat Bench, Indoor
Designed by Studio Gorm, 2020



Depth	Width	Height
17.75"	85.5"	17"

Core Product

Three Slat Bench - Beech, Indoor

Core Code

SG03-IND-S3-86W-B

Standard with Core Product

Glides
Solid Beech Wood Frame

Upholstery Configurations

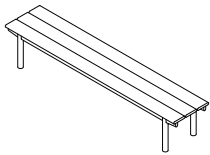

Configuration 1.3
(none)

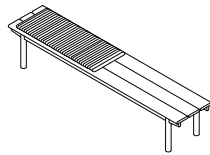

Configuration 2.3
-PC2

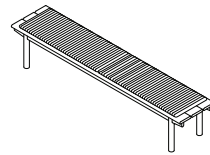

Configuration 3.3
-PC2-PG2

Textile Yardage

Pad: 1.50 (each)

Upholstery Configurations - List Price by Textile Grade

	COM	1	2	3	4	5	6	7	8	9	10	11	12	13	14	15
Configuration 1.3	2316	n/a	n/a	n/a	n/a	n/a	n/a	n/a	n/a	n/a	n/a	n/a	n/a	n/a	n/a	n/a
Configuration 2.3	2941	3019	3039	3063	3079	3100	3120	3148	3186	3223	3270	3325	3382	3504	3598	3786
Configuration 3.3	3566	3722	3761	3809	3842	3884	3923	3980	4055	4130	4223	4334	4448	4691	4880	5255

Options and Notes overleaf

Options

Wood Species	Code	List Price Add
Beech	B	0
Ash	A	244
Walnut	W	2684

Wood Finishes

Clear over Beech/Ash/Walnut	WCB/WCA/WCW	0
Gray over Ash	WGA	236
Oak over Ash	WOA	158
Walnut over Ash	WWA	158
Navy Painted Wood (Ash)	WNP	236

Accessories (see below for visuals)

Table, Round	T1	426
Table, Obround	T2	526
Power Module/s	PM1/PM2	315/899

Other Options

Veneer Table Top(s), Beech	VTB	0
Veneer Table Top(s), Ash	VTA	28
Veneer Table Top(s), Walnut	VTW	30
Forbo Linoleum Table Top(s)	FTT	178

Accessories (visuals)

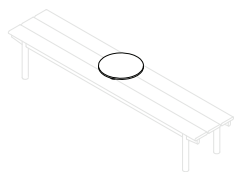

Table, Round
See below for locations

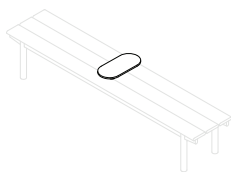

Table, Obround
See below for locations

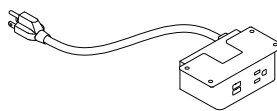

Power Module
1-Power, 2-USB

Table Locations (Round Table shown)

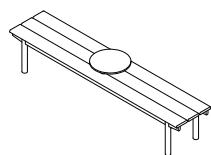

-T1E2
For Configurations 1.3, 3.3

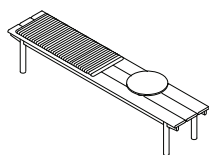

-T1G2
For Configuration 2.3

Notes overleaf

Specifiable Finishes

Linoleum	Choose from Forbo linoleum products on page 7
Textiles	Choose from Maharam or Kvadrat textiles on page 83, or contact Memo for assistance with COM fabrics
Wood/Veneer	Choose from Memo Wood Finishes on page 7

Notes

Pricing includes Freight within Continental US

For step-by-step specifications and quotes, access our live quote tool online at → [Quotes](#)

Maru Benches

Five Slat Bench, Indoor
Designed by Studio Gorm, 2020

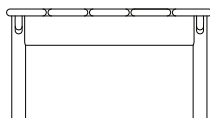

Depth	Width	Height
29.75"	85.5"	17"

Core Product

Five Slat Bench - Beech, Indoor

Core Code

SG03-IND-S5-86W-B

Standard with Core Product

Glides
Solid Beech Wood Frame

Upholstery Configurations

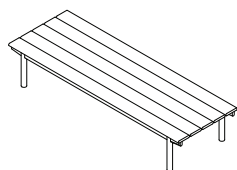

Configuration 1.5
(none)

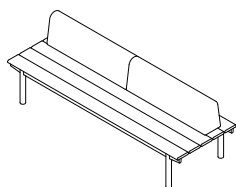

Configuration 2.5
-BC2-BG2

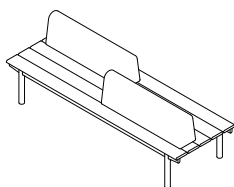

Configuration 3.5
-BC2-BG4

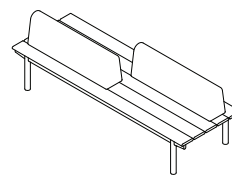

Configuration 4.5
-BC4-BG2

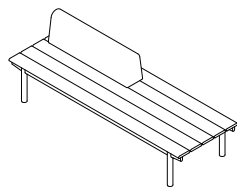

Configuration 5.5
-BC2

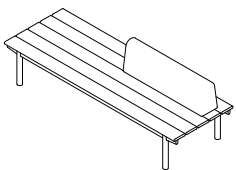

Configuration 6.5
-BG2

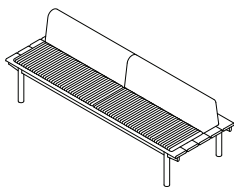

Configuration 7.5
-BC2-BG2-PC4-PG4

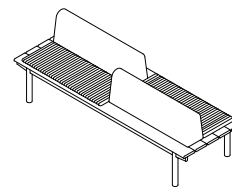

Configuration 8.5
-BC2-BG4-PC4-PG2

More Configurations, Pricing, Options, and Notes overleaf

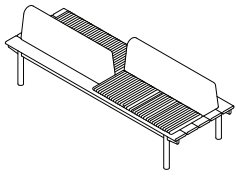

Configuration 9.5
-BG4-BG2-PC2-PG4

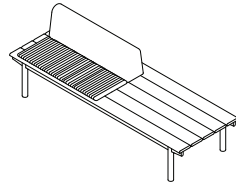

Configuration 10.5
-BC2-PC4

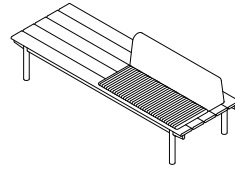

Configuration 11.5
-BG2-PG4

Textile Yardage

Bolster: 1.25 (each)
Pad: 1.50 (each)

Upholstery Configurations - List Price by Textile Grade*

	COM	1	2	3	4	5	6	7	8	9	10	11	12	13	14	15
Configuration 1.5	3240	n/a	n/a	n/a	n/a	n/a	n/a	n/a	n/a	n/a	n/a	n/a	n/a	n/a	n/a	n/a
Configuration 2.5	4448	4578	4611	4651	4678	4713	4746	4793	4856	4918	4996	5088	5183	5386	5543	5856
Configuration 3.5	4448	4578	4611	4651	4678	4713	4746	4793	4856	4918	4996	5088	5183	5386	5543	5856
Configuration 4.5	4448	4578	4611	4651	4678	4713	4746	4793	4856	4918	4996	5088	5183	5386	5543	5856
Configuration 5.5	3844	3909	3925	3945	3959	3977	3993	4017	4048	4079	4118	4164	4212	4313	4392	4548
Configuration 6.5	3844	3909	3925	3945	3959	3977	3993	4017	4048	4079	4118	4164	4212	4313	4392	4548
Configuration 7.5	5698	5984	6056	6144	6204	6281	6353	6457	6595	6732	6903	7106	7315	7761	8107	8795
Configuration 8.5	5698	5984	6056	6144	6204	6281	6353	6457	6595	6732	6903	7106	7315	7761	8107	8795
Configuration 9.5	5698	5984	6056	6144	6204	6281	6353	6457	6595	6732	6903	7106	7315	7761	8107	8795
Configuration 10.5	4469	4612	4648	4692	4722	4761	4796	4849	4917	4986	5071	5173	5278	5500	5674	6017
Configuration 11.5	4469	4612	4648	4692	4722	4761	4796	4849	4917	4986	5071	5173	5278	5500	5674	6017

*Pricing assumes single textile selection for pads and bolsters. For multiple textiles please visit → Quotes

Options

Wood Species	Code	List Price Add
Beech	B	0
Ash	A	800
Walnut	W	5140

Wood Finishes

Clear over Beech/Ash/Walnut	WCB/WCA/WCW	0
Gray over Ash	WGA	284
Oak over Ash	WOA	205
Walnut over Ash	WWA	205
Navy Painted Wood (Ash)	WNP	284

More Options, Visuals, and Notes overleaf

Accessories (see below for visuals)

	Code	List Price Add
Dowel Partition, Beech	SCR1B	2591
Dowel Partition, Ash	SCR1A	2853
Dowel Partition, Walnut	SCR1W	3308
Table, Round	T1	426
Table, Obround	T2	526
Power Module/s	PM1/PM2	315/899

Other Options

Multiple Textiles (bolster/pad)	TA	140
Veneer Table Top(s), Beech	VTB	0
Veneer Table Top(s), Ash	VTA	28 (per table)
Veneer Table Top(s), Walnut	VTW	30 (per table)
Forbo Linoleum Table Top(s)	FTT	178 (per table)

Accessories (visuals)

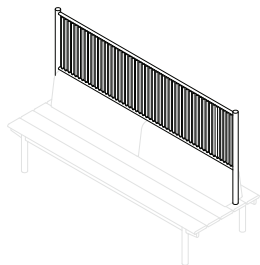

Dowel Partition
Only for Configurations 2.5, 7.5

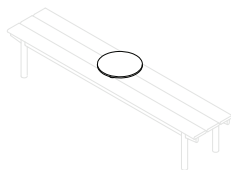

Table, Round
See below for locations

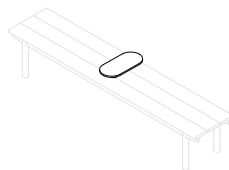

Table, Obround
See below for locations

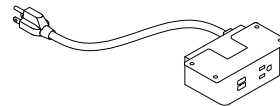

Power Module
1-Power, 2-USB

Table Locations (Round Table shown)

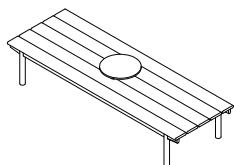

-T1E3
For Configuration 1.5

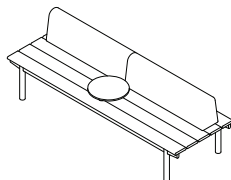

-T1E4
For Configurations 2.5, 5.5, 6.5,
7.5, 10.5, 11.5

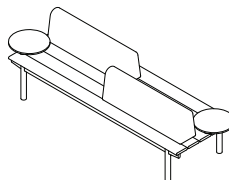

-T1A4-T1I2
For Configuration 3.5, 8.5

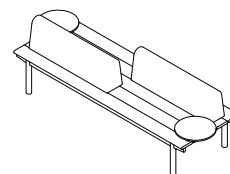

-T1A2-T1I4
For Configuration 4.5, 9.5

Specifiable Finishes

Linoleum

Choose from Forbo linoleum products on page 7

Textiles

Choose from Maharam or Kvadrat textiles on page 83, or contact Memo for assistance with COM fabrics

Wood/Veneer

Choose from Memo Wood Finishes on page 7

Notes overleaf

Notes

Pricing includes Freight within Continental US

For step-by-step specifications and quotes, access our live quote tool online at → [Quotes](#)

Maru Benches

Seven Slat Bench, Indoor
Designed by Studio Gorm, 2020



Depth	Width	Height
41.75"	85.5"	17"

Core Product

Seven Slat Bench - Beech, Indoor

Core Code

SG03-IND-S7-86W-B

Standard with Core Product

Glides
Solid Beech Wood Frame

Upholstery Configurations

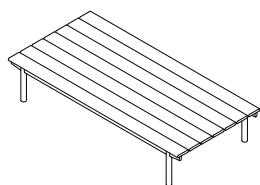

Configuration 1.7
(none)

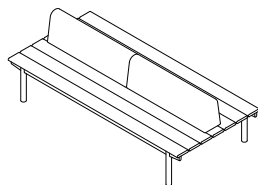

Configuration 2.7
-BC4-BG4

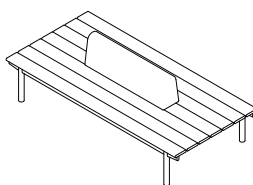

Configuration 3.7
-BE4

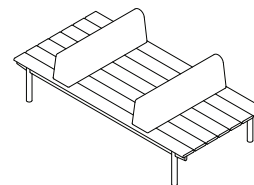

Configuration 4.7
-BC4R-BG4R

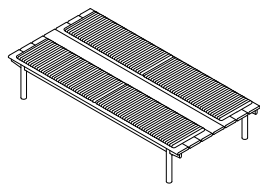

Configuration 5.7
-PC2-PC6-PG2-PG6

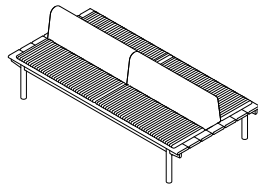

Configuration 6.7
-BC4-BG4-PC2-PC6-PG2-PG6

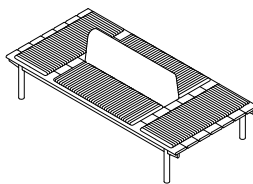

Configuration 7.7
-BE4-PB4R-PE2-PE6-PH4R

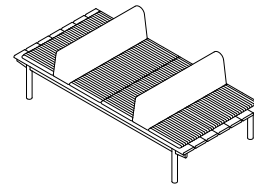

Configuration 8.7
-BC4R-BG4R-PB4R-PD4R-PF4R-PH4R

Pricing, Options, and Notes overleaf

Textile Yardage

Bolster: 1.25 (each)
Pad: 1.50 (each)

Upholstery Configurations - List Price by Textile Grade*

	COM	1	2	3	4	5	6	7	8	9	10	11	12	13	14	15
Configuration 1.7	3660	n/a	n/a	n/a	n/a	n/a	n/a	n/a	n/a	n/a	n/a	n/a	n/a	n/a	n/a	n/a
Configuration 2.7	4868	4998	5031	5071	5098	5133	5166	5213	5276	5338	5416	5508	5603	5806	5963	6276
Configuration 3.7	4264	4329	4345	4365	4379	4397	4413	4437	4468	4499	4538	4584	4632	4733	4812	4968
Configuration 4.7	4868	4998	5031	5071	5098	5133	5166	5213	5276	5338	5416	5508	5603	5806	5963	6276
Configuration 5.7	6160	6472	6550	6646	6712	6796	6874	6988	7138	7288	7474	7696	7924	8410	8788	9538
Configuration 6.7	7368	7810	7921	8057	8150	8269	8380	8541	8754	8966	9230	9544	9867	10556	11091	12154
Configuration 7.7	6764	7141	7235	7351	7431	7533	7627	7765	7946	8127	8352	8620	8896	9483	9940	10846
Configuration 8.7	7368	7810	7921	8057	8150	8269	8380	8541	8754	8966	9230	9544	9867	10556	11091	12154

*Pricing assumes single textile selection for pads and bolsters. For multiple textiles please visit → Quotes

Options

Wood Species	Code	List Price Add
Beech	B	0
Ash	A	880
Walnut	W	5700

Wood Finishes

Clear over Beech/Ash/Walnut	WCB/WCA/WCW	0
Gray over Ash	WGA	331
Oak over Ash	WOA	252
Walnut over Ash	WWA	252
Navy Painted Wood (Ash)	WNP	331

Accessories (see following page for visuals)

Dowel Partition, Beech	SCR1B	2591
Dowel Partition, Ash	SCR1A	2853
Dowel Partition, Walnut	SCR1W	3308
Table, Round	T1	426
Table, Obround	T2	526
Power Module/s	PM1/PM2	315/899

More Options, Visuals, and Notes overleaf

Other Options

	Code	List Price Add
Multiple Textiles (bolster/pad)	TA	140
Veneer Table Top(s), Beech	VTB	0
Veneer Table Top(s), Ash	VTA	28 (per table)
Veneer Table Top(s), Walnut	VTW	30 (per table)
Forbo Linoleum Table Top(s)	FTT	178 (per table)

Accessories (visuals)

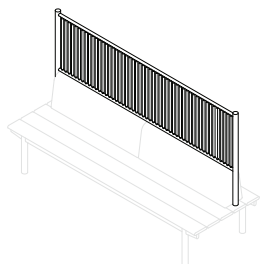

Dowel Partition
Only for Configurations 2.7, 6.7

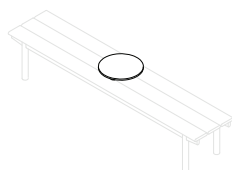

Table, Round
See below for locations

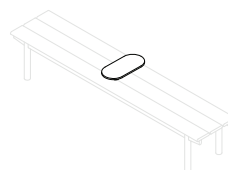

Table, Obround
See below for locations

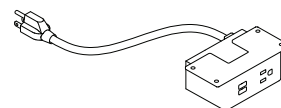

Power Module
1-Power, 2-USB

Table Locations (Round Table shown)

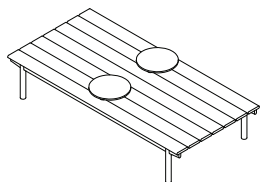

-T1E2-T1E6
For Configurations 1.7, 5.7

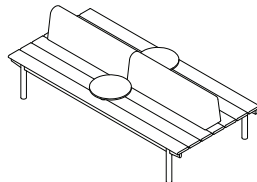

-T1E2-T1E6
For Configurations 2.7, 6.7

Specifiable Finishes

Linoleum

Choose from Forbo linoleum products on page 7

Textiles

Choose from Maharam or Kvadrat textiles on page 83, or contact Memo for assistance with COM fabrics

Wood/Veneer

Choose from Memo Wood Finishes on page 7

Notes

Pricing includes Freight within Continental US

For step-by-step specifications and quotes, access our live quote tool online at → [Quotes](#)

Penna

Lounge

Designed by Studio Gorm, 2019

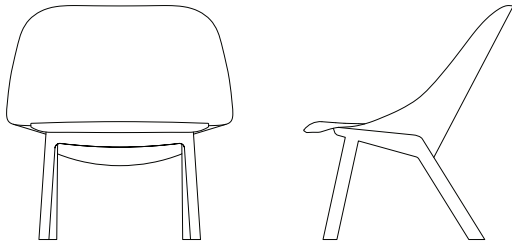

Depth	Width	Height
32"	25.5"	30"

Core Product

Lounge - Ash
Lounge - Walnut

Core Code

SG01-01-A
SG01-01-W

Textile Yardage

Total: 3.5

Seat	Back	Arms
1.0	2.5	n/a

List Price by Textile Grade*

	COM	1	2	3	4	5	6	7	8	9	10	11	12	13	14	15
SG01-01-A	2772	2954	3000	3056	3094	3143	3189	3255	3343	3430	3539	3668	3801	4085	4305	4743
SG01-01-W	3352	3534	3580	3636	3674	3723	3769	3835	3923	4010	4119	4248	4381	4665	4885	5323

*Pricing assumes a single textile selection for seat and back. For multiple textiles please visit → Quotes

Standard with Core Product

Non-Marring Glides

Options and Notes overleaf

Options

Component	Code	List Price Add
Multiple Textiles (Seat/Back)	TA	140

Specifiable Finishes

Textiles	Choose from Maharam or Kvadrat textiles on page 83, or contact Memo for assistance with COM fabrics
Wood	Choose from Memo Wood Finishes on page 7

Notes

Pricing includes Freight within Continental US

Multiple Textile option allows for separate seat and back textiles

For step-by-step specifications and quotes, access our live quote tool online at → [Quotes](#)

Penna

Large Round Table

Designed by Studio Gorm, 2019

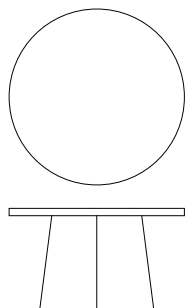

Depth	Width	Height
30"	30"	17.5"

Core Product	Core Code	List Price
Large Round Table - Ash	SG01-T1-A	2345
Large Round Table - Walnut	SG01-T1-W	2407

Standard with Core Product

- Glides
- Forbo Linoleum Top
- Solid Wood Edge Band (finish to match base)
- Wood Veneer Base

Options

Component	Code	List Price Add
Forbo Linoleum Top	FTT	0
Wood Veneer Top (Ash)	VTA	80
Wood Veneer Top (Walnut)	VTW	122
Power Module (2-power, 2-USB)	PM1	343

Specifiable Finishes

- Linoleum Choose from Forbo linoleum products on page 7
- Wood Choose from Memo Wood Finishes on page 7

Notes

Pricing includes freight within Continental US
For step-by-step specifications and quotes, access our live quote tool online at → Quotes

Penna

Obround Table

Designed by Studio Gorm, 2019

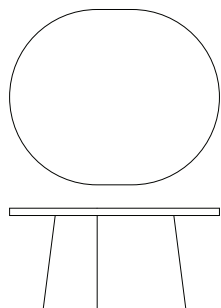

Depth	Width	Height
30"	36"	17.5"

Core Product	Core Code	List Price
Obround Table - Ash	SG01-T2-A	2807
Obround Table - Walnut	SG01-T2-W	2872

Standard with Core Product

- Glides
- Forbo Linoleum Top
- Solid Wood Edge Band (finish to match base)
- Wood Veneer Base

Options

Component	Code	List Price Add
Forbo Linoleum Top	FTT	0
Wood Veneer Top (Ash)	VTA	105
Wood Veneer Top (Walnut)	VTW	139
Power Module (2-power, 2-USB)	PM1	343

Specifiable Finishes

- Linoleum Choose from Forbo linoleum products on page 7
- Wood Choose from Memo Wood Finishes on page 7

Notes

Pricing includes Freight within Continental US
For step-by-step specifications and quotes, access our live quote tool online at → Quotes

Penna

Small Round Table

Designed by Studio Gorm, 2019

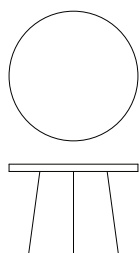

Depth	Width	Height
22.5"	22.5"	16"

Core Product	Core Code	List Price
Small Round Table - Ash	SG01-T3-A	2041
Small Round Table - Walnut	SG01-T3-W	2106

Standard with Core Product

- Glides
- Forbo Linoleum Top
- Solid Wood Edge Band (finish to match base)
- Wood Veneer Base

Options

Component	Code	List Price Add
Forbo Linoleum Top	FTT	0
Wood Veneer Top (Ash)	VTA	64
Wood Veneer Top (Walnut)	VTW	102
Power Module (2-power, 2-USB)	PM1	343

Specifiable Finishes

- Linoleum Choose from Forbo linoleum products on page 7
- Wood Choose from Memo Wood Finishes on page 7

Notes

Pricing includes Freight within Continental US
For step-by-step specifications and quotes, access our live quote tool online at → Quotes

Penna

Bar Table

Designed by Studio Gorm, 2020

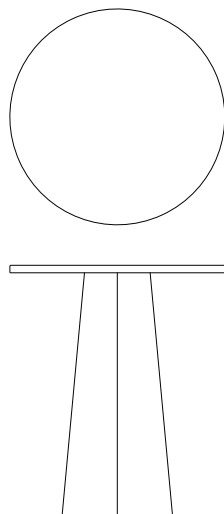

Depth	Width	Height
36"	36"	42"

Core Product	Core Code	List Price
Bar Table - Ash	SG01-T8-36D-A	4676
Bar Table - Walnut	SG01-T8-36D-W	4999

Standard with Core Product

- Glides
- Forbo Linoleum Top
- Solid Wood Edge Band (finish to match base)
- Wood Veneer Base

Options

Component	Code	List Price Add
Forbo Linoleum Top	FTT	0
Wood Veneer Top (Ash)	VTA	356
Wood Veneer Top (Walnut)	VTW	405
Power Module (2-power, 2-USB)	PM1	343

Specifiable Finishes

- Linoleum Choose from Forbo linoleum products on page 7
- Wood Choose from Memo Wood Finishes on page 7

Notes

Bases ship with sandbags in certain models, for ballast

Pricing includes freight within Continental US

For step-by-step specifications and quotes, access our live quote tool online at → [Quotes](#)

Penna

Café Table

Designed by Studio Gorm, 2020

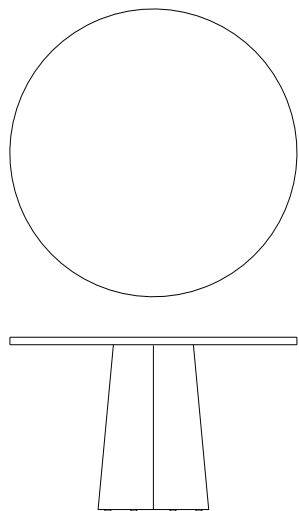

Depth	Width	Height
48"	48"	29"

Core Product	Core Code	List Price
Café Table - Ash	SG01-T6-48D-A	4601
Café Table - Walnut	SG01-T6-48D-W	4946

Standard with Core Product

- Glides
- Forbo Linoleum Top
- Solid Wood Edge Band (finish to match base)
- Wood Veneer Base

Options

Component	Code	List Price Add
Forbo Linoleum Top	FTT	0
Wood Veneer Top (Ash)	VTA	390
Wood Veneer Top (Walnut)	VTW	409
Power Module (2-power, 2-USB)	PM1	343

Specifiable Finishes

- Linoleum Choose from Forbo linoleum products on page 7
- Wood Choose from Memo Wood Finishes on page 7

Notes

Bases ship with sandbags in certain models, for ballast

Pricing includes freight within Continental US

For step-by-step specifications and quotes, access our live quote tool online at → [Quotes](#)

Penna

Meeting Table

Designed by Studio Gorm, 2020

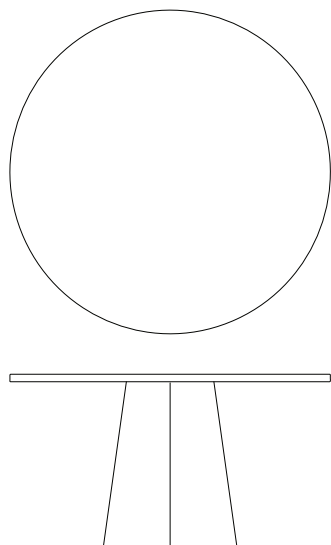

Depth	Width	Height
54"	54"	29"

Core Product	Core Code	List Price
Meeting Table - Ash	SG01-T7-54D-A	5179
Meeting Table - Walnut	SG01-T7-54D-W	5539

Standard with Core Product

- Glides
- Forbo Linoleum Top
- Solid Wood Edge Band (finish to match base)
- Wood Veneer Base

Options

Component	Code	List Price Add
Forbo Linoleum Top	FTT	0
Wood Veneer Top (Ash)	VTA	454
Wood Veneer Top (Walnut)	VTW	514
Power Module (2-power, 2-USB)	PM1	343

Specifiable Finishes

- Linoleum Choose from Forbo linoleum products on page 7
- Wood Choose from Memo Wood Finishes on page 7

Notes

Bases ship with sandbags in certain models, for ballast

Pricing includes freight within Continental US

For step-by-step specifications and quotes, access our live quote tool online at → [Quotes](#)

Prose Seating

Side Chair with Arms

Designed by Memo Studio, 2017

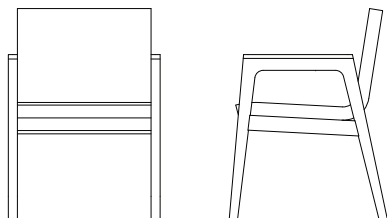

Depth	Width	Height
24"	23"	33"

Core Product

- Side Chair with Arms - Ash
- Side Chair with Arms - Beech
- Side Chair with Arms - Walnut

Core Code

- GC01-10-A
- GC01-10-B
- GC01-10-W

Textile Yardage	Seat	Back	Arms
Total: 1.50	n/a	n/a	n/a

List Price by Textile Grade

	COM	1	2	3	4	5	6	7	8	9	10	11	12	13	14	15
GC01-10-A	1543	1621	1641	1665	1681	1702	1722	1750	1788	1825	1872	1927	1984	2106	2200	2388
GC01-10-B	1384	1462	1482	1506	1522	1543	1563	1591	1629	1666	1713	1768	1825	1947	2041	2229
GC01-10-W	2534	2612	2632	2656	2672	2693	2713	2741	2779	2816	2863	2918	2975	3097	3191	3379

Standard with Core Product

- Glides
- High Resilience Poyeurethane Foam

Options

Component	Code	List Price Add						
Solid Surface Arm Caps	by Grade (right)	CA1	CA2	CA3	CA4	CA5	CA6	CA7
		265	322	322	454	454	529	529
Removable Covers	RC	149						
Moisture Barrier	MB	222						
CAL TB 133	FB	222						

Specifiable Finishes

- Solid Surface Choose from Corian solid surface products on page 95
- Textiles Choose from Maharam or Kvadrat textiles on page 83, or contact Memo for assistance with COM fabrics
- Wood Choose from Memo Wood Finishes on page 7

Notes

Pricing includes Freight within Continental US
 Due to its continuous seat and back, multiple fabric configurations are not supported on the Prose Side Chair with Arms
 For step-by-step specifications and quotes, access our live quote tool online at memofurniture.com/quotes

Prose Seating

Plus Chair

Designed by Memo Studio, 2017

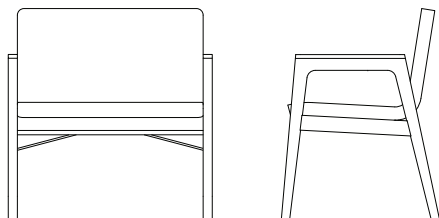

Depth	Width	Height
24"	30.75"	33"

Core Product

- Plus Chair - Ash
- Plus Chair - Beech
- Plus Chair - Walnut

Core Code

- GC01-15-A
- GC01-15-B
- GC01-15-W

Textile Yardage

Total: 2.00

Seat Back Arms

n/a n/a n/a

List Price by Textile Grade

	COM	1	2	3	4	5	6	7	8	9	10	11	12	13	14	15
GC01-15-A	1964	2068	2094	2126	2148	2176	2202	2240	2290	2340	2402	2476	2552	2714	2840	3090
GC01-15-B	1768	1872	1898	1930	1952	1980	2006	2044	2094	2144	2206	2280	2356	2518	2644	2894
GC01-15-W	2849	2953	2979	3011	3033	3061	3087	3125	3175	3225	3287	3361	3437	3599	3725	3975

Standard with Core Product

Glides

High Resilience Poyeurethane Foam

Options

Component	Code	List Price Add						
Solid Surface Arm Caps	by Grade (right)	CA1	CA2	CA3	CA4	CA5	CA6	CA7
		265	322	322	454	454	529	529
Removable Covers	RC	179						
Moisture Barrier	MB	222						
CAL TB 133	FB	222						

Specifiable Finishes

- Solid Surface Choose from Corian solid surface products on page 95
- Textiles Choose from Maharam or Kvadrat textiles on page 83, or contact Memo for assistance with COM fabrics
- Wood Choose from Memo Wood Finishes on page 7

Notes

Pricing includes Freight within Continental US
 Due to its continuous seat and back, multiple fabric configurations are not supported on the Prose Plus Chair
 For step-by-step specifications and quotes, access our live quote tool online at memofurniture.com/quotes

Prose Seating

Settee

Designed by Memo Studio, 2017

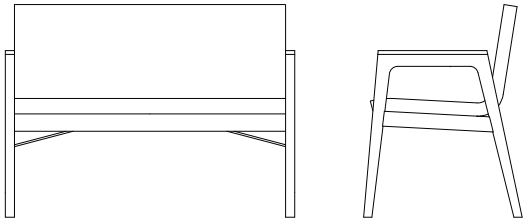

Depth	Width	Height
24"	43.75"	33"

Core Product

- Settee - Ash
- Settee - Beech
- Settee - Walnut

Core Code

- GC01-22-A
- GC01-22-B
- GC01-22-W

Textile Yardage

Total: 2.50

Seat	Back	Arms
n/a	n/a	n/a

List Price by Textile Grade

	COM	1	2	3	4	5	6	7	8	9	10	11	12	13	14	15
GC01-22-A	2576	2706	2739	2779	2806	2841	2874	2921	2984	3046	3124	3216	3311	3514	3671	3984
GC01-22-B	2352	2482	2515	2555	2582	2617	2650	2697	2760	2822	2900	2992	3087	3290	3447	3760
GC01-22-W	3266	3396	3429	3469	3496	3531	3564	3611	3674	3736	3814	3906	4001	4204	4361	4674

Standard with Core Product

Glides

High Resilience Polyurethane Foam

Options

Component	Code	List Price Add						
Solid Surface Arm Caps	by Grade (right)	CA1	CA2	CA3	CA4	CA5	CA6	CA7
		265	322	322	454	454	529	529
Removable Covers	RC	179						
Moisture Barrier	MB	252						
CAL TB 133	FB	252						

Specifiable Finishes

- Solid Surface Choose from Corian solid surface products on page 95
- Textiles Choose from Maharam or Kvadrat textiles on page 83, or contact Memo for assistance with COM fabrics
- Wood Choose from Memo Wood Finishes on page 7

Notes

Pricing includes Freight within Continental US
 Due to its continuous seat and back, multiple fabric configurations are not supported on the Prose Settee
 For step-by-step specifications and quotes, access our live quote tool online at memofurniture.com/quotes

Prose Seating

Pull-Up Chair

Designed by Memo Studio, 2017

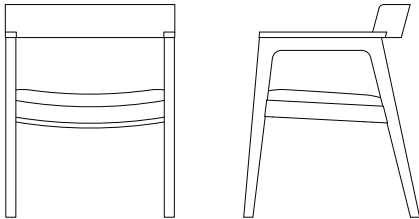

Depth	Width	Height
24"	23"	29.5"

Core Product

- Pull-Up Chair - Ash
- Pull-Up Chair - Beech
- Pull-Up Chair - Walnut

Core Code

- GC01-11-A
- GC01-11-B
- GC01-11-W

Textile Yardage	Seat	Back	Arms
Total: 1.00	n/a	n/a	n/a

List Price by Textile Grade

	COM	1	2	3	4	5	6	7	8	9	10	11	12	13	14	15
GC01-11-A	1634	1686	1699	1715	1726	1740	1753	1772	1797	1822	1853	1890	1928	2009	2072	2197
GC01-11-B	1558	1610	1623	1639	1650	1664	1677	1696	1721	1746	1777	1814	1852	1933	1996	2121
GC01-11-W	2534	2586	2599	2615	2626	2640	2653	2672	2697	2722	2753	2790	2828	2909	2972	3097

Standard with Core Product

- Glides
- High Resilience Poyeurethane Foam

Options

Component	Code	List Price Add
Removable Covers	RC	119
Moisture Barrier	MB	122
CAL TB 133	FB	122

Specifiable Finishes

- Textiles Choose from Maharam or Kvadrat textiles on page 83, or contact Memo for assistance with COM fabrics
- Wood Choose from Memo Wood Finishes on page 7

Notes

Pricing includes Freight within Continental US
For step-by-step specifications and quotes, access our live quote tool online at memofurniture.com/quotes

Prose Seating

Lounge

Designed by Memo Studio, 2017

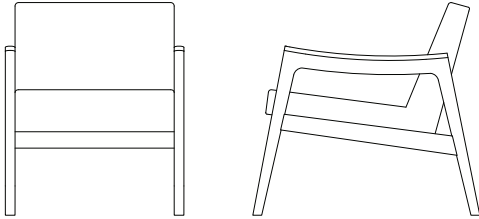

Depth	Width	Height
32"	25.5"	30"

Core Product

- Lounge - Ash
- Lounge - Beech
- Lounge - Walnut

Core Code

- GC01-01-A
- GC01-01-B
- GC01-01-W

Textile Yardage	Seat	Back	Arms
Total: 2.00	1.00	1.00	n/a

List Price by Textile Grade

	COM	1	2	3	4	5	6	7	8	9	10	11	12	13	14	15
GC01-01-A	2312	2416	2442	2474	2496	2524	2550	2588	2638	2688	2750	2824	2900	3062	3188	3438
GC01-01-B	2092	2196	2222	2254	2276	2304	2330	2368	2418	2468	2530	2604	2680	2842	2968	3218
GC01-01-W	3269	3373	3399	3431	3453	3481	3507	3545	3595	3645	3707	3781	3857	4019	4145	4395

Standard with Core Product

- Glides
- High Resilience Poyeurethane Foam

Options

Component	Code	List Price Add						
Solid Surface Arm Caps	by Grade (right)	CA1	CA2	CA3	CA4	CA5	CA6	CA7
		265	322	322	454	454	529	529
Removable Covers	RC	179						
Moisture Barrier	MB	222						
CAL TB 133	FB	222						
Multiple Textiles (Seat/Back)	TA	140						

Specifiable Finishes

- Solid Surface Choose from Corian solid surface products on page 95
- Textiles Choose from Maharam or Kvadrat textiles on page 83, or contact Memo for assistance with COM fabrics
- Wood Choose from Memo Wood Finishes on page 7

Notes

- Pricing includes Freight within Continental US
- Available in custom widths per engineering and quote approval
- Multiple fabric option allows for separate seat and back textiles
- For step-by-step specifications and quotes, access our live quote tool online at memofurniture.com/quotes

Prose Seating

Loveseat

Designed by Memo Studio, 2017

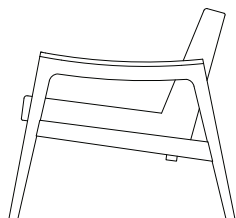
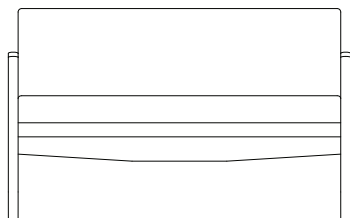

Depth	Width	Height
32"	48"	30"

Core Product

- Loveseat - Ash
- Loveseat - Beech
- Loveseat - Walnut

Core Code

- GC01-02-A
- GC01-02-B
- GC01-02-W

Textile Yardage	Seat	Back	Arms
Total: 4.00	2.00	2.00	n/a

List Price by Textile Grade

	COM	1	2	3	4	5	6	7	8	9	10	11	12	13	14	15
GC01-02-A	3204	3412	3464	3528	3572	3628	3680	3756	3856	3956	4080	4228	4380	4704	4956	5456
GC01-02-B	2896	3104	3156	3220	3264	3320	3372	3448	3548	3648	3772	3920	4072	4396	4648	5148
GC01-02-W	4515	4723	4775	4839	4883	4939	4991	5067	5167	5267	5391	5539	5691	6015	6267	6767

Standard with Core Product

- Glides
- High Resilience Poyeurethane Foam

Options

Component	Code	List Price Add						
Solid Surface Arm Caps	by Grade (right)	CA1	CA2	CA3	CA4	CA5	CA6	CA7
		265	322	322	454	454	529	529
Removable Covers	RC	219						
Moisture Barrier	MB	252						
CAL TB 133	FB	252						
Multiple Textiles (Seat/Back)	TA	140						

Specifiable Finishes

- Solid Surface Choose from Corian solid surface products on page 95
- Textiles Choose from Maharam or Kvadrat textiles on page 83, or contact Memo for assistance with COM fabrics
- Wood Choose from Memo Wood Finishes on page 7

Notes

Pricing includes Freight within Continental US
 Available in custom widths per engineering and quote approval
 Multiple fabric option allows for separate seat and back textiles
 For step-by-step specifications and quotes, access our live quote tool online at memofurniture.com/quotes

Prose Tables

Free-Standing End Table
Designed by Memo Studio, 2017

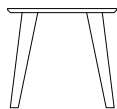

Depth	Width	Height
20"	20"	18.5"

Core Product	Core Code	List Price
Free-Standing End Table - Ash	GC01-T1-A	1216
Free-Standing End Table - Beech	GC01-T1-B	976
Free-Standing End Table - Walnut	GC01-T1-W	1463

Standard with Core Product

- Glides
- Forbo Linoleum Top

Options

Component	Code	List Price Add
Solid Surface Table Top	by Grade (right)	CT1 350
		CT2 433
Solid Wood Table Top - Ash	WTA	CT3 433
		CT4 608
Solid Wood Table Top - Walnut	WTW	CT5 608
		CT6 711
		CT7 711

Specifiable Finishes

- Linoleum Choose from Forbo linoleum products on page 7
- Solid Surface Choose from Corian solid surface products on page 95
- Wood Choose from Memo Wood Finishes on page 7

Notes

Pricing includes Freight within Continental US
For step-by-step specifications and quotes, access our live quote tool online at memofurniture.com/quotes

Prose Tables

Free-Standing Coffee Table
Designed by Memo Studio, 2017

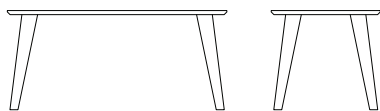

Depth	Width	Height
20"	40"	18.5"

Core Product	Core Code	List Price
Free-Standing Coffee Table - Ash	GC01-T2-A	1768
Free-Standing Coffee Table - Beech	GC01-T2-B	1356
Free-Standing Coffee Table - Walnut	GC01-T2-W	1929

Standard with Core Product

- Glides
- Forbo Linoleum Top

Options

Component	Code	List Price Add
Solid Surface Table Top	by Grade (right)	CT1 550
		CT2 633
Solid Wood Table Top - Ash	WTA	CT3 633
		CT4 808
Solid Wood Table Top - Walnut	WTW	CT5 808
		CT6 911
		CT7 911

Specifiable Finishes

- Linoleum Choose from Forbo linoleum products on page 7
- Solid Surface Choose from Corian solid surface products on page 95
- Wood Choose from Memo Wood Finishes on page 7

Notes

Pricing includes Freight within Continental US
For step-by-step specifications and quotes, access our live quote tool online at memofurniture.com/quotes

Rolo

Lounge

Designed by Studio Tolvanen, 2021

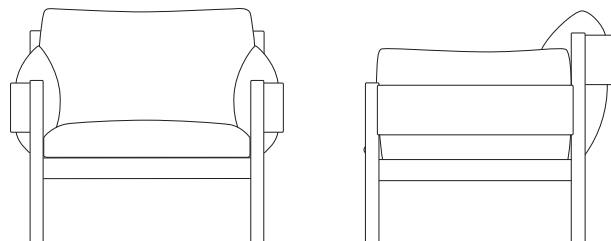

Depth Width Height
32" 36" 31"

Core Product

Lounge - Ash
Lounge - Walnut

Core Code

ST01-01-A
ST01-01-W

Textile Yardage

Total: 3.75 (railroaded)

List Price by Textile Grade*

	COM	1	2	3	4	5	6	7	8	9	10	11	12	13	14	15
ST01-01-A	3673	3868	3917	3977	4018	4070	4119	4190	4284	4378	4494	4633	4775	5079	5315	5784
ST01-01-W	4196	4391	4439	4499	4541	4593	4642	4713	4807	4901	5017	5156	5298	5602	5838	6307

*Pricing assumes railroaded textiles. For non-railroaded pricing please contact us at info@memofurniture.com

Standard with Core Product

Non-Marring Glides
High Resilience Polyurethane Foam

Options and Notes overleaf

Options

Specifiable Finishes

- Textiles Choose from Maharam or Kvadrat textiles on page 83, or contact Memo for assistance with COM fabrics
- Wood Choose from Memo Wood Finishes on page 7

Notes

- Pricing includes Freight within Continental US
- Multiple Textile option allows for separate seat and back + arms textiles
- For step-by-step specifications and quotes, access our live quote tool online at → [Quotes](#)

Rolo

Loveseat

Designed by Studio Tolvanen, 2021

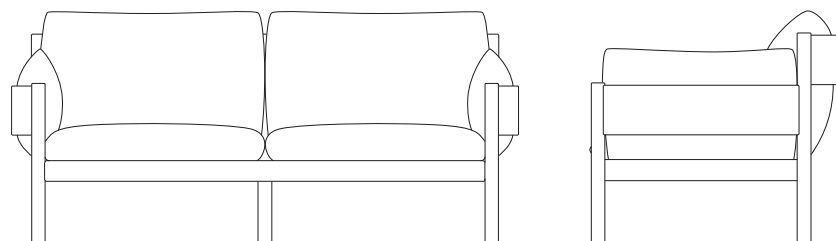

Depth Width Height
32" 65" 31"

Core Product

Loveseat - Ash
Loveseat - Walnut

Core Code

ST01-02-A
ST01-02-W

Textile Yardage

Total: 5.75 (railroaded)

List Price by Textile Grade*

	COM	1	2	3	4	5	6	7	8	9	10	11	12	13	14	15
ST01-02-A	5448	5747	5822	5914	5977	6058	6133	6242	6386	6529	6708	6920	7139	7605	7967	8686
ST01-02-W	6403	6702	6776	6868	6932	7012	7087	7196	7340	7484	7662	7875	8093	8559	8921	9640

*Pricing assumes railroaded textiles. For non-railroaded pricing please contact us at info@memofurniture.com

Standard with Core Product

Non-Marring Glides
High Resilience Polyurethane Foam

Options and Notes overleaf

Options

Specifiable Finishes

- Textiles Choose from Maharam or Kvadrat textiles on page 83, or contact Memo for assistance with COM fabrics
- Wood Choose from Memo Wood Finishes on page 7

Notes

- Pricing includes Freight within Continental US
- Multiple Textile option allows for separate seat and back + arms textiles
- For step-by-step specifications and quotes, access our live quote tool online at → [Quotes](#)

Rolo

Sofa

Designed by Studio Tolvanen, 2021

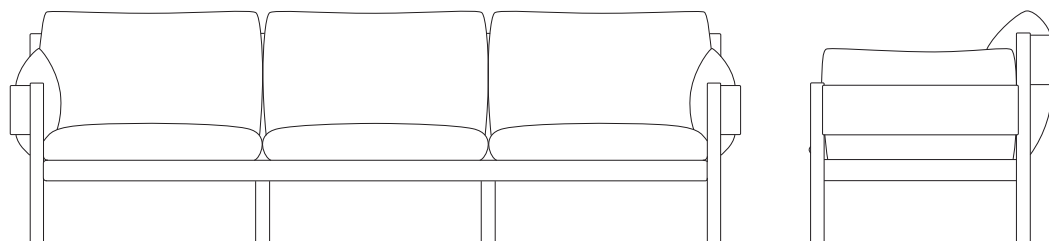

Depth Width Height
32" 94" 31"

Core Product

Sofa - Ash
Sofa - Walnut

Core Code

ST01-03-A
ST01-03-W

Textile Yardage

Total: 7.5 (railroaded)

List Price by Textile Grade*

	COM	1	2	3	4	5	6	7	8	9	10	11	12	13	14	15
ST01-03-A	7431	7730	7805	7897	7960	8040	8115	8224	8368	8512	8690	8903	9121	9587	9949	10668
ST01-03-W	8515	8814	8889	8981	9044	9125	9199	9309	9452	9596	9774	9987	10206	10671	11034	11752

*Pricing assumes railroaded textiles. For non-railroaded pricing please contact us at info@memofurniture.com

Standard with Core Product

Non-Marring Glides
High Resilience Polyurethane Foam

Options and Notes overleaf

Options

Specifiable Finishes

- Textiles Choose from Maharam or Kvadrat textiles on page 83, or contact Memo for assistance with COM fabrics
- Wood Choose from Memo Wood Finishes on page 7

Notes

Pricing includes Freight within Continental US

Multiple Textile option allows for separate seat and back + arms textiles

For step-by-step specifications and quotes, access our live quote tool online at → [Quotes](#)

Rolo

Side Table

Designed by Studio Tolvanen, 2021

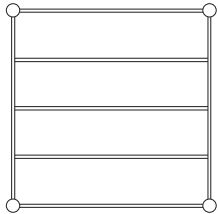

Depth	Width	Height
27.75"	27.75"	11"

Core Product	Core Code	List Price
Side Table - Ash	ST01-T1-A	1233
Side Table - Walnut	ST01-T1-W	1889

Standard with Core Product
Glides

Options

Specifiable Finishes

Wood Choose from Memo Wood Finishes on page 7

Notes

Pricing includes freight within Continental US

For step-by-step specifications and quotes, access our live quote tool online at → [Quotes](#)

Rolo

Coffee Table

Designed by Studio Tolvanen, 2021

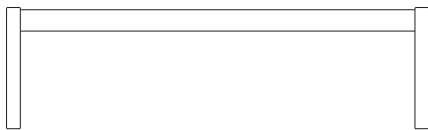
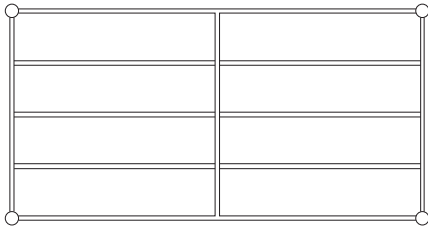

Depth	Width	Height
27.75"	53.75"	15"

Core Product	Core Code	List Price
Coffee Table - Ash	ST01-T2-A	1539
Coffee Table - Walnut	ST01-T2-W	2659

Standard with Core Product

Glides

Options

Specifiable Finishes

Wood Choose from Memo Wood Finishes on page 7

Notes

Pricing includes freight within Continental US

For step-by-step specifications and quotes, access our live quote tool online at → Quotes

Textiles Graded-in sorted by pattern name: **Kvadrat**

Pattern Name	Group	Pattern Name	Group
Apparel by Febrik	12	Novus 2 (RAF)	11
Atlas	8	Parkland	8
Atom (RAF)	13	Patio	7
Balder 3 (RAF)	11	Phlox (RAF)	9
Basel	6	Pilot (RAF)	13
Byram (RAF)	14	Planum by Febrik	10
Canvas 2	7	Plecto by Febrik	11
Clara	7	Pro 3	8
Coda	11	Razzle Dazzle by Febrik	12
Colline	8	Recheck	7
Crystal Field	14	Reflect	6
Divina 3	8	Reflex (RAF)	13
Divina MD	8	Revive 1	8
Divina Melange	8	Re-Wool	7
Drop by Febrik	12	Remix	7
Field 2	8	Ria (RAF)	14
Fiord 2	9	Rime	9
Floyd	8	San	8
Forest Nap	6	Savanna	8
Foss	9	Silas (RAF)	14
Fuse (RAF)	13	Sonar 3 (RAF)	13
Galaxy	8	Sprinkles by Febrik	12
Gentle 2.1 by Febrik	14	Star	10
Glow	7	Steelcut 2	8
Hallingdal	9	Steelcut Trio	8
Harald 3 (RAF)	9	Stick Tree	8
Hella (RAF)	13	Still	8
Hero	7	Sunniva 2 (RAF)	9
Highfield 3	9	Tambourine Hallingdal	14
Husk by Febrik	12	Tonica 2	7
Jaali	8	Tonus	8
Lila	10	Triangle by Febrik	12
Maple	8	Twill Weave	8
Masai (RAF)	11	Uniform by Febrik	11
Matrix	10	Vidar 3 (RAF)	12
Melange Nap	8	Waterborn	12
Memory	8		
Molly 2	7		
Mosiac by Febrik	12		
Nitto by Febrik	9		
Noise (RAF)	12		
Novus 1 (RAF)	11		

Textiles Graded-in sorted by pattern name: **Maharam**

Pattern Name	Pattern No.	Group	Pattern Name	Pattern No.	Group
A Band Apart	466000	15	Buffer	466492	7
Abacus	466118	8	Bureau	466472	4
Abacus Standard	466140	6	Bushel	466490	8
Across	465964	8	Campana	466571	8
Agency	466001	15	Candid	463720	6
Akimbo	464770	8	Candor	466496	6
Albemarle	466435	11	Caper	466384	5
Alloy	466064	7	Carapace	466261	12
Alpaca Epingle	465902	15	Chalet	466324	8
Alpaca Velvet	465901	15	Chasm	466404	7
Alter	464880	7	Chassis	466458	7
Amulet	466482	11	Checker	459830	13
Ample	466532	10	Checker Split	460290	13
Anagram	466067	9	Chime	465350	6
Angles	466477	14	Circles	458310	13
Apex	466522	7	Circuit	466089	7
Apt	466392	6	Clamber	466385	8
Arabesque	466204	12	Coach Cloth	458950	13
Arcade	466447	10	Coast	466439	6
Aria	459950	13	Coin	466233	6
Article	458600	2	Coin Crypton	466236	7
Bander	466442	13	Coincide	465808	5
Bavaria Stripe	466161	14	Coincide High Performance	466132	7
Beacon	466405	9	Colorwheel	466163	10
Beck	466570	7	Column	466192	8
Beryl	466508	7	Compartment	466154	15
Beside	464020	8	Compound	466196	7
Bespoke Stripe	463540	14	Conduit	466428	5
Big Stripe	466174	14	Confetti	466203	11
Bind	466437	11	Fore	466464	12
Bitmap	466066	6	Cosset	466524	8
Blended Stripe	466412	14	Cotton Velvet	466199	13
Blocks	466209	15	Cove	466526	12
Bluff	466489	7	Crew	466149	8
Blumen	462870	12	Croft	466498	14
Boundary	466193	6	Crosspatch	458920	12
Bright Angle	466331	10	Crush	464780	8
Bright Cube	466329	10	Cursive	466335	9
Bright Grid	466330	10	Cycle	466275	6
Brim	466350	9	Dapper	466316	6
Brindle	466418	5	Darning Sampler	466460	10
Brio	466386	7	Darning Sampler Large	466461	11

Textiles Graded-in sorted by pattern name: **Maharam**

Pattern Name	Pattern No.	Group	Pattern Name	Pattern No.	Group
Darning Sampler Plaid	466462	12	Gemma	466568	8
Deconstructed Rose	466086	15	Gemma Multi	466569	8
Design 9297	465230	13	Geometri	459970	13
Dingbats	465994	11	Gild	466432	7
Disc	466221	6	Glaze	466506	13
Ditto	465993	8	Glid	466432	7
Divide	466220	6	Glow	466500	7
Divide Crypton	466238	7	Grade	466260	9
Dot Pattern	458300	12	Grid	466210	15
Dots	466411	12	Grove	466344	7
Double Triangles	459840	13	Gust	466519	6
Drape	466145	8	Hearth	466536	10
Dwell	466419	3	Herringbone Stripe	465945	14
Eden	466258	15	Hewn	466398	10
Edges	466476	12	Houndstooth	466253	11
Ellipsis	466334	7	Huddle	466420	14
Embed	466457	7	Idle	466466	13
Emboss	466281	8	Imbue	466375	11
Emit	466378	6	Industry	466255	15
Enmesh	466338	6	Inlay	466353	11
Entwine	466397	10	Insignia	466308	9
Epingle Stripe	466007	14	Instill	466351	6
Equate	466383	7	Jasper	466563	7
Etch	466502	12	Keen	466433	6
Exaggerated Plaid	466039	13	Knot	466248	12
Exchange	466027	6	Lariat	440401	2
Facets	459850	13	Layers Garden	465916	14
Fathom	466013	6	Layers Park	465918	14
Feature	466343	7	Layers Vineyard Large	465921	14
Festoon	466525	8	Layers Vineyard Small	465920	14
Flint	466543	8	Lea	466548	10
Fluent Crypton	466073	8	Lean	466438	6
Flurry	466480	12	Ledger	463770	6
Fluted Silk	465982	12	Lens	466323	6
Flutter	466430	14	Letters	462560	13
Fold	466292	8	Levity	466518	7
Foliage	466257	15	Lift	466302	9
Fore	466464	11	Limn	466407	10
Frequency	466504	6	Linden	466537	7
Fruit	466262	11	Lineage	466127	6
Gallant	466485	6	Linen Basket	466541	14
Garden	466134	10	Link	466328	9

Textiles Graded-in sorted by pattern name: **Maharam**

Pattern Name	Pattern No.	Group	Pattern Name	Pattern No.	Group
Lithe	466394	7	Ottoman Stripe	466142	14
Loop	466469	6	Overlapping Stripe	466495	13
Luce	466566	8	Painted Stripe	465998	13
Lunar	466356	5	Palio	466107	12
Manner	466177	1	Parched Silk	465974	13
Mantle	466517	5	Pare	466359	7
Marquee	463890	5	Parquet	466376	9
Massive Paisley	465915	15	Passel	466470	14
Mechanism	465952	10	Pebble Wool	457401	14
Medium	463490	2	Pebble Wool Multi	461200	14
Mela	466483	13	Pepper	466486	6
Melange Tweed	461190	13	Petra	466580	8
Meld	466387	1	Pick	466224	6
Meridian	464710	7	Pick Crypton	466235	7
Merit	466444	2	Pinnacle	466503	7
Mesh	466371	10	Pitch	466186	6
Messenger	458640	1	Plait	466052	6
Metric	466014	1	Plume	466382	12
Micro	466099	6	Pocket	466243	8
Mikado	459330	12	Point	466090	13
Milestone	403901	4	Pressed Linen	466380	14
Millerstripe	462250	14	Pressed Plaid	466181	14
Mimic	466136	9	Prime	466436	8
Mineral	466232	7	Prompt	466493	6
Mingled Plaid	466364	14	Province	466549	7
Minicheck	466268	13	Quatrefoil	459340	12
Mister	466178	9	Quay	466390	7
Mode	466337	2	Quell	466366	13
Mohair Supreme	451801	14	Queue	466443	7
Monk's Wool	457301	14	Rail	466535	8
Monsoon	466481	10	Reef	466332	11
Motley	466360	6	Regatta	466189	9
Multiply	466341	5	Relay	466453	11
Murmur	466446	2	Repeat Classic Stripe	462170	14
Muse	466487	1	Repeat Dot Ring	462150	14
Names	462510	13	Rill	466370	6
Nestle	466388	12	Roam	466520	14
Nimble	466488	7	Roman	466565	10
Offset	465951	10	Roster	466445	4
Optik	459960	13	Rove	466096	5
Orakelblume	463900	13	Rule	466190	8
Orbit	466415	5	Runner	466108	8

Textiles Graded-in sorted by pattern name: **Maharam**

Pattern Name	Pattern No.	Group	Pattern Name	Pattern No.	Group
Runner Standard	466167	6	Teatro	466309	10
Scape	466357	9	Tempera	466426	8
Scuba	464930	7	Tend	466352	7
Scute	466396	6	Terra	466572	11
Scuttle	466429	7	The Firm	465999	15
Segmented Stripe	466373	11	The Story of My Life	464670	13
Sendal	466550	7	Ticker	466304	7
Sequence	466179	7	Tilt	466256	8
Sequential Stripe	466377	14	Toostripe	462260	14
Serried	466408	8	Tracery	466372	10
Shadow	466521	7	Trait	464830	7
Sheen	466246	7	Trees	466195	11
Shift	466527	11	Trellis	466244	8
Shuttle Standard	466168	6	Tress	466529	13
Sift	466479	11	Trio	466088	10
Silk Canvas	465985	12	Trundle	466434	5
Skein	466170	6	Twice	465909	6
Slumber	466365	12	Unisol	461160	13
Small Dot Pattern	458320	12	Urban	466079	8
Soft Tweed	466197	11	Valor	466491	11
Songbird	466523	14	Vases	466164	10
Sort	466273	6	Veer	466497	6
Span	466395	7	Velvet Stripe	466279	14
Spare	466465	11	Vestige	466259	8
Splay	466448	6	Vineyard	466133	10
Spry	466414	6	Voyage	456801	12
Stature	466180	6	Waver	466459	7
Steady	465947	6	Wend	466381	6
Steady Crypton	465946	8	Wool Check	466501	13
Stripes	463980	14	Wide Corduroy	466552	13
Strum	466122	7	Wool Rib	466198	11
Study	466269	10	Wool Striae	466184	14
Sudden	463000	8	Wool Velvet	466120	14
Sundry	466441	10	Wrap	466231	6
Superweave	466241	15			
Swathe	466416	11			
Switch	466515	7			
Swivel	466374	8			
Tandem	466321	6			
Tangram	466084	11			
Taper	466413	10			
Taut Linen	466530	12			

Textiles Graded-in sorted by Grading Group: **Kvadrat**

Group & Price/yard	Pattern Name	Group & Price/yard	Pattern Name
Group 1:52			Tonus
Group 2:65			Twill Weave
Group 3:81		Group 9: 188	Fiord 2
Group 4:92			Foss
Group 5: 106			Hallingdal
			Harald 3 (RAF)
Group 6: 119	Basel		Highfield 3
	Forest Nap		Phlox (RAF)
	Reflect		Rime
			Nitto by Febrik
Group 7: 138	Canvas 2		Sunniva 2 (RAF)
	Clara		
	Glow	Group 10: 219	Lila
	Hero		Matrix
	Molly 2		Star
	Patio		Planum by Febrik
	Remix		
	Recheck	Group 11: 256	Balder 3 (RAF)
	Re-Wool		Coda
	Tonica 2		Masai (RAF)
			Novus 1 (RAF)
Group 8: 163	Atlas		Novus 2 (RAF)
	Colline		Uniform by Febrik
	Divina 3		Plecto by Febrik
	Divina MD		
	Divina Melange	Group 12: 294	Noise (RAF)
	Field 2		Vidar 3 (RAF)
	Floyd		Waterborn
	Galaxy		Apparel by Febrik
	Jaali		Drop by Febrik
	Maple		Husk by Febrik
	Melange Nap		Mosiac by Febrik
	Memory		Razzle Dazzle by Febrik
	Parkland		Sprinkles by Febrik
	Pro 3		Triangle by Febrik
	Revive 1		
	San	Group 13: 375	Atom (RAF)
	Savanna		Fuse (RAF)
	Steelcut 2		Hella (RAF)
	Steelcut Trio		Pilot (RAF)
	Stick Tree		Reflex (RAF)
	Still		Sonar 3 (RAF)

Textiles Graded-in sorted by Grading Group: **Kvadrat**

Group & Price/yard	Pattern Name
Group 14: 438	Gentle 2.1 by Febrik
	Byram (RAF)
	Crystal Field
	Ria (RAF)
	Silas (RAF)
	Tambourine Hallingdale

Group 15: 563

Textiles Graded-in sorted by Grading Group: **Maharam**

Group & Price/yard	Pattern Name	Number	Group & Price/yard	Pattern Name	Number
Group 1: 52	Manner	466177	Group 6: 119	Bluff	466489
	Meld	466387		Boundary	466193
	Messenger	458640		Buffer	466492
	Metric	466014		Candid	463720
	Muse	466487		Candor	466496
Group 2: 65	Article	458600		Chime	465350
	Lariat	440401		Coast	466439
	Medium	463490		Coin	466233
	Merit	466444		Cycle	466275
	Mode	466337		Dapper	466316
	Murmur	466446		Disc	466221
Group 3: 81	Dwell	466419		Divide	466220
				Emit	466378
Group 4: 92	Milestone	403901		Enmesh	466338
	Pallet	466531		Exchange	466027
	Roster	466445		Fathom	466013
Group 5: 106	Brindle	466418		Frequency	466504
	Bureau	466472		Gallant	466485
	Caper	466384		Glow	466500
	Coincide	465808	Gust	466519	
	Conduit	466428	Instill	466351	
	Emit	466378	Keen	466433	
	Fathom	466013	Lean	466438	
	Glen	466534	Ledger	463770	
	Lineage	466127	Lens	466323	
	Lunar	466356	Lineage	466127	
	Mantle	466517	Loop	466469	
	Marquee	463890	Micro	466099	
	Multiply	466341	Motley	466360	
	Nico	466564	Pepper	466486	
	Orbit	466415	Pitch	466186	
	Pick	466224	Pick	466224	
	Rove	466096	Plait	466052	
Trundle	466434	Prompt	466493		
Group 6: 119	Abacus Standard	466140	Queue	466443	
	Apex	466522	Rill	466370	
	Apt	466392	Rule	466190	
	Bitmap	466066	Runner Standard	466167	
			Scute	466396	
		Shuttle Standard	466168		
		Skein	466170		
		Sort	466273		

Textiles Graded-in sorted by Grading Group: **Maharam**

Group & Price/yd	Pattern Name	Number	Group & Price/yd	Pattern Name	Number
Group 6: 119	Splay	466448	Group 7: 138	Pinnacle	466503
	Spry	466414		Province	466549
	Stature	466180		Quay	466390
	Steady	465947		Queue	466443
	Tandem	466321		Scuba	464930
	Twice	465909		Scuttle	466429
	Veer	466497		Sendal	466550
	Wend	466381		Sequence	466179
	Willow	466542		Shadow	466521
	Wrap	466231		Sheen	466246
	Group 7: 138	Alloy		466064	Span
Alter		464880	Strum	466122	
Apex		466522	Switch	466515	
Beck		466570	Tend	466352	
Beryl		466508	Ticker	466304	
Bluff		466489	Trait	464830	
Brio		466386	Waver	466459	
Buffer		466492	Group 8: 163	Abacus	466118
Bushel		466490		Across	465964
Chasm		466404		Akimbo	464770
Chassis		466458		Beside	464020
Circuit		466089		Bushel	466490
Coin Crypton		466236		Campana	466571
Coincide High Performance		466132		Chalet	466324
Compound		466196		Clamber	466385
Divide Crypton		466238		Column	466192
Ellipsis		466334		Cosset	466524
Embed		466457		Crew	466149
Equate		466383	Crush	464780	
Feature		466343	Ditto	465993	
Gild		466432	Drape	466145	
Grove		466344	Emboss	466281	
Jasper	466563	Festoon	466525		
Levity	466518	Flint	466543		
Linden	466537	Fluent Crypton	466073		
Lithe	466394	Fold	466292		
Meridian	464710	Gemma	466568		
Mineral	466232	Gemma Multi	466569		
Nimble	466488	Luce	466566		
Pare	466359	Mister	466178		
Pick Crypton	466235	Parquet	466376		

Textiles Graded-in sorted by Grading Group: **Maharam**

Group & Price/yd	Pattern Name	Number	Group & Price/yd	Pattern Name	Number
Group 8: 163	Petra	466580	Group 10: 219	Hearth	466536
	Pocket	466243		Hewn	466398
	Prime	466436		Lea	466548
	Raas	466471		Limn	466407
	Rail	466535		Mechanism	465952
	Regatta	466189		Mesh	466371
	Runner	466108		Monsoon	466481
	Serried	466408		Offset	465951
	Steady Crypton	465946		Roman	466565
	Sudden	463000		Study	466269
	Swivel	466374		Sundry	466441
	Tempera	466426		Taper	466413
	Tilt	466256		Teatro	466309
	Trellis	466244		Tracery	466372
	Urban	466079		Trio	466088
	Vestige	466259		Vases	466164
Group 9: 188	Anagram	466067	Group 11: 256	Vineyard	466133
	Arcade	466447		Albemarle	466435
	Beacon	466405		Amulet	466482
	Brim	466350		Bind	466437
	Cursive	466335		Confetti	466203
	Grade	466260		Darning Sampler Large	466461
	Insignia	466308		Dingbats	465994
	Lift	466302		Etch	466502
	Link	466328		Fore	466464
	Mimic	466136		Fruit	466262
	Mister	466178		Houndstooth	466253
	Parquet	466376		Imbue	466375
	Regatta	466189		Inlay	466353
	Rule	466190		Reef	466332
	Scape	466357		Relay	466453
	Group 10: 219	Ample		466532	Segmented Stripe
Arcade		466447	Shift	466527	
Bright Angle		466331	Sift	466479	
Bright Cube		466329	Soft Tweed	466197	
Bright Grid		466330	Spare	466465	
Colorwheel		466163	Swathe	466416	
Darning Sampler		466460	Tangram	466084	
Entwine		466397	Terra	466572	
Garden		466134	Trees	466195	
			Valor	466491	

Textiles Graded-in sorted by Grading Group: **Maharam**

Group & Price/yard	Pattern Name	Number	Group & Price/yard	Pattern Name	Number
Group 11: 256	Wool Rib	466198	Group 13: 375	Facets	459850
Group 12: 294	Arabesque	466204		Geometri	459970
	Aria	459950		Glaze	466506
	Blumen	462870		Idle	466466
	Carapace	466261		Letters	462560
	Circles	458310		Mela	466483
	Cove	466526		Melange Tweed	461190
	Crosspatch	458920		Minicheck	466268
	Darning Sampler Plaid	466462		Names	462510
	Design 9297	465230		Optik	459960
	Dot Pattern	458300		Orakelblume	463900
	Dots	466411		Overlapping Stripe	466495
	Edges	466476		Painted Stripe	465998
	Etch	466502		Parched Silk	465974
	Flurry	466480		Ply Mesh Black/Tan	465020
	Fluted Silk	465982		Point	466090
	Fore	466464		Quell	466366
	Glaze	466506		The Story of My Life	464670
	Idle	466466		Tress	466529
	Knot	466248		Unisol	461160
	Mikado	459330		Wide Corduroy	466552
	Nestle	466388		Wool Check	466501
	Orakelblume	463900	Group 14: 438	Angles	466477
	Overlapping Stripe	466495		Bavaria Stripe	466161
	Palio	466107		Bespoke Stripe	463540
	Plume	466382		Big Stripe	466174
	Quatrefoil	459340		Blended Stripe	466412
	Silk Canvas	465985		Croft	466498
	Slumber	466365		Epingle Stripe	466007
	Small Dot Pattern	458320		Flutter	466430
	Taut Linen	466530		Herringbone Stripe	465945
	Voyage	456801		Huddle	466420
Group 13: 375	Aria	459950		Layers Garden	465916
	Bander	466442		Layers Park	465918
	Checker	459830		Layers Vineyard Large	465921
	Checker Split	460290		Layers Vineyard Small	465920
	Coach Cloth	458950		Linen Basket	466541
	Cotton Velvet	466199		Millerstripe	462250
	Design 9297	465230		Mingled Plaid	466364
	Double Triangles	459840		Mohair Supreme	451801
	Exaggerated Plaid	466039		Monk's Wool	457301

Textiles Graded-in sorted by Grading Group: **Maharam**

Group & Price/yard	Pattern Name	Number	Group & Price/yard	Pattern Name	Number
Group 14: 438	Ottoman Stripe	466142			
	Passel	466470			
	Pebble Wool	457401			
	Pebble Wool Multi	461200			
	Pressed Linen	466380			
	Pressed Plaid	466181			
	Repeat Classic Stripe	462170			
	Repeat Dot Ring	462150			
	Roam	466520			
	Sequential Stripe	466377			
	Songbird	466523			
	Stripes	463980			
	Toostripe	462260			
	Velvet Stripe	466279			
	Wool Striae	466184			
	Wool Velvet	466120			
	Group 15: 563	A Band Apart	466000		
Agency		466001			
Alpaca Epingle		465902			
Alpaca Velvet		465901			
Assembled Check		466345			
Blocks		466209			
Colorfield		466315			
Compartment		466154			
Croft		466498			
Deconstructed Rose		466086			
Eden		466258			
Foliage		466257			
Grid		466210			
Industry		466255			
Massive Paisley		465915			
Superweave		466241			
The Firm		465999			

Corian Solid Surface Schedule sorted by Grading Group

Group 1	Abalone *Bisque *Bone *Cameo White *Glacier White Linen Maui Sahara Sandstone Silver Gray Vanilla	Group 4	Deep Caviar Deep Mink Deep Night Sky Dove Flint Fossil Granola Pine Raffia Rice Paper Royal Red Seafoam Serene Sage Suede Venaro White Whisper White Jasmine	Group 5	Whipped Cream Willow	Group 7	Minera Nimbus Prima Sagebrush Sand Storm Smoke Drift Prima Sonora Stardust White Onyx Windswept Prima
Group 2	Antarctica Aurora Blue Pebble Canyon Cocoa Brown Designer White Modern White Mojave Sand Savannah Stratus Summit White	Group 5	Anthracite Ash Concrete Blue Spice Carbon Concrete Cilantro Deep Anthracite Deep Bedrock Deep Cloud Deep Espresso Deep Nocturne Deep Sable Deep Space Deep Storm Deep Titanium Doeskin Fawn Glacier Ice Matterhorn Neutral Concrete Oat Silver Birch Silverite Weathered Concrete	Group 6	Arrowroot Basil Clam Shell Cool Gray Cosmos Prima Earth Gray Onyx Hazelnut Jasmine Keystone Lava Rock Limev Prima Natural Gray Rain Cloud Riverbed Rosemary Saffron Sandalwood Sorrel Tumbleweed Witch Hazel		
Group 3	Elegant Gray Everest Moss Nightfall Pearl Gray Platinum Silt Sparkling White			Group 7	Allspice Aqualite Burlled Beach Cocoa Prima Deep Inkwell Deep Lapis Deep Smoky Pear Deep Terrain Dune Prima Ecru Elderberry Evening Prima Graylite Hickory Smoke Juniper Milky Way		
Group 4	Arctic Ice Bronzite Canvas Cobalt Concrete Cottage Lane Deep Black Quartz						

*Only these finishes are currently available for Sink Stations (GS02-S1 & GS02-S2)

Leather Arm Wrap Colors for Chroma Lounge

Select [Maharam Pace](#) colors

Shy	L002
Granite	L003
Proper	L007
Darkroom	L009
Rodeo	L027
Desert	L032

