

**memo**

Pricelist  
2024 / Q1

**memo**

## Contents

page 3 Terms of Sale  
page 4 Limited Lifetime Warranty  
page 5 Customer Service  
page 6 Finishes Overview  
page 8 Textiles Overview

### page 12 April Seating

page 12 Side Chair  
page 13 Counter Stool  
page 14 Bar Stool

### page 17 Chord Tables

page 17 Personal Table  
page 19 Side Table  
page 21 Coffee Table

### page 23 Chroma Seating

page 23 Lounge  
page 24 Lounge Armless  
page 25 Lounge Swivel  
page 26 Ottoman - 17  
page 27 Ottoman - 24  
page 28 Ottoman - 29  
page 29 Ottoman - 38

### page 30 Ida

page 30 Ida

### page 31 Kino

page 31 Kino

### page 33 Maru Benches

page 33 Three Slat Bench, 3/4 Length  
page 35 Three Slat Bench  
page 37 Five Slat Bench  
page 40 Seven Slat Bench

### page 43 Orca Screens

page 43 Vertical Screen  
page 45 Horizontal Screen

### page 47 Penna Seating

page 47 Penna Lounge

### page 48 Penna Tables

page 48 Large Round  
page 49 Obround  
page 50 Small Round  
page 51 Bar Table  
page 53 Café Table  
page 55 Meeting Table  
page 57 Height Adjustable Cafe table 24-42, 48 diameter  
page 59 Height Adjustable Meeting table 24-42, 54 diameter  
page 61 Height Adjustable Cafe table 29-42, 48 diameter  
page 63 Height Adjustable Meeting table 24-42, 54 diameter

### page 65 Prose Seating

page 65 Side Chair with Arms  
page 67 Plus Chair  
page 69 Settee  
page 71 Lounge  
page 73 Loveseat

### page 73 Rolo Seating

page 75 Lounge  
page 76 Loveseat  
page 77 Sofa

### page 78 Rolo Tables

page 78 Side Table  
page 79 Coffee Table

### page 80 Materials & Finishes Schedules

page 80 Textiles Schedule  
page 82 Corian Solid Surface Schedule

## Terms of Sale

### Pricing Policy

All prices shown for products and accessories are manufacturer's suggested list price. Prices shown do not include freight, surcharges, appropriate taxes, crating (if applicable), storage, or installation charges. Memo reserves the right to amend price lists, change designs, and discontinue or add models without prior notice. Price list of latest date supersedes and cancels all previous lists. All orders accepted are subject to prices upon receipt of order.

### Payment Terms

Except as otherwise specified, all orders require a 50% deposit with the balance due with thirty (30) days from the invoice date. All payments are payable in U.S. dollars. Lead times start after the receipt of deposit. Payments not made by the due date may incur, at the sole discretion of Memo, a late payment service charge of 1.5% per month. All payments and deposits are non-refundable.

### Changes and Cancellations

Customers will receive a written confirmation of pricing, credit terms and estimated completion date. Changes to orders or cancellations made after production has begun will carry extra charges based on expenses incurred.

### Shipping

Standard cartoning and standard surface freight to any point within the 48 contiguous United States is included in Memo quotes as a separate charge independent of product price. For shipments to Alaska, Hawaii and International destinations, additional shipping and handling charges will apply. Orders are shipped cartoned as standard. If crating is requested or required, additional charges will apply and a custom quote will be provided. Service add-ons for freight will also include additional charges as follows:

Gate Lift : \$125 NET

Residential Delivery : \$150 NET

Delivery Appointment in Advance: \$100 NET

Any additional freight charges will be provided at the time of quote. From time to time, market conditions for fuel and/or labor may result in freight surcharges, beyond our standard rates. In these cases, surcharges will be indicated on all quotes.

### Freight Claims

Product is shipped FOB Factory, freight prepaid and allowed via truck. The title of goods changes to the purchaser when merchandise leaves Memo's dock. All shipments are transferred to the transportation company in good condition.

Receiver and/or specifier are required to inspect cartons and product upon receipt and note the condition and any damage or shortage on the Bill of Lading upon delivery. Receiver and or specifier are required to notify Memo and the carrier of evident damage or product shortages at time of delivery and request an inspection. Failure to report evident damage or product shortages within (3) business days of delivery will be considered total and full acceptance of goods as is. In the case of shipping damage, the receiver and/or specifier is to provide Memo with photographs of the damaged carton/packaging and goods. Photographs are required for Memo to process and award if approved, any claims for recovery. Shipping cartons and packaging should be retained for carrier inspection and the damaged product should be kept in the receiving location. If the freight carrier will not perform the inspection, receiver and/or specifier should prepare an affidavit; noting that the freight company refused to comply with an inspection - citing date and time.

Any concealed damage claims against Memo for apparent damages must be made by the purchaser and or specifier in writing within five (5) business days of delivery, including a copy of the BOL and photographs of the carton/ packaging and damaged goods. Failure to notify Memo within 5 business days of receipt shall constitute acceptance of the product and waiver of any apparent damages resulting in replacement and or repair of damaged goods being billed to the purchaser.

Any relevant damage or shortages to blanket wrapped shipments must be noted on the Bill of Lading at the time of delivery.

**Custom Requests**

Requests to modify existing products (Modifications) or to produce ground-up solutions (Specials) should be submitted to our customer service group, at which time they will be assessed and submitted for design and engineering approval. All custom requests will elicit a receipt and a response will be provided within 48 hours of receipt. Upon approval, a price and lead-time quote will be generated and provided for customer review and acceptance.

**Limited Lifetime Warranty**

Memo Furniture warrants its products, to the original user and for the original purpose, to be free of defects in design, material and workmanship, given normal use and care for the lifetime of the product from the date of invoice. This warranty does not include damage from accident, alteration, misuse, normal wear and tear, transportation or improper installation and maintenance.

During the warranty period, Memo Furniture, at its option, will repair or replace any product which, upon inspection by Memo Furniture or its designated representative, is deemed to be defective in materials or workmanship and is covered by this warranty.

This warranty does not apply to defects in components not manufactured by Memo Furniture. In these cases, the warranty period provided by the supplier of the component will apply. The liability of Memo Furniture is limited to furnishing new parts as may be necessary to replace any item that may prove to be defective in material or workmanship. Memo Furniture will make every effort to replace parts if they are available from the supplier of those parts. We will not assume liability of charges for labor, consequential expenses or damages incurred.

Textiles and leathers are not warranted against fading or normal wear, customer induced cuts or tears or irregularities in the registration of printed textile patterns. Due to natural variations, in which Memo Furniture has no control, this warranty does not extend to color, grain, texture or the durability or suitability of any exterior surface coatings or treatments.

This warranty is void in cases of damage in transit, negligence, abuse, abnormal usage, misuse, accidents, and improper cleaning and maintenance. Normal aging and wear of woven and non-woven upholstery are exempt from this warranty.

All other warranties, expressed or implied, are excluded. Memo Furniture shall not be liable for incidental or consequential damages of any sort.

If you have any questions or wish to file a claim against this warranty, please contact Customer Service at +1 206 995 8780.

## Customer Service

Memo's Customer Service Group is trained to assist with quotes, orders, custom requests, product details, warranty inquiries, and to answer general questions.

We can be reached Monday through Friday, 7:00 am – 5:00 pm Pacific Time, directly via email at [service@memofurniture.com](mailto:service@memofurniture.com) or via our voicemail line at +1 206 995 8780.

Inquiries received after-hours via voicemail or email will receive a response before the close of business on the following business day.

Please visit [www.memofurniture.com](http://www.memofurniture.com) for answers to most questions including product prices, specifications, photos, SketchUp and Revit files, and marketing material.

Please visit our quote tool <https://staging-quotes.memofurniture.com> for 24/7 live access to quotes and our configurator. Additionally, a local sales representative can assist you further. Contact names and numbers are also available on our website.

## Finishes

Memo offers a range of proprietary colors and finishes on select materials, as well as support for a broad range of open line laminates and solid surface. Our finishes have been curated to offer a foundation of essential base neutrals, to which accents and stronger colors can be added.

Memo offers finish and pattern selections in the following materials:

### **Forbo Furniture Linoleum**

Memo offers Forbo furniture-grade linoleum on select products. Forbo is a durable surface material, available in a dynamic range of colors. Derived from solidified Linseed Oil and other natural fillers such as cork and wood dust, Forbo is a sustainable and resilient surface choice.

### **Metal Powder Coat**

Our powder coats are applied to both steel and aluminum, and are available in textured and smooth finishes. Powder coating is extremely durable and emits zero pollutants once cured.

### **Natural Stone**

Memo offers natural stone on select table and horizontal surface tops. Our stone is hand selected from the highest quality slabs however natural variances will occur from product to product.

### **Solid Surface**

Memo offers Corian and Wilsonart solid surface options on certain products. Solid Surface, is a non-porous high durability product that is stain resistant, easy to clean, and easily repairable.

### **Wood & Veneer**

Our products utilize both solid wood and wood veneer, and are offered in either Ash, Beech or Walnut depending on the product. Products with edge profiles will include a matching wood edge. Wood products are finished in a resilient, long lasting, conversion varnish.

**Memo Colors and Finishes**

**Metal Powder Coat**

Steel Gray Gloss	MSG
Med Bronze Gloss	MMB
Black Texture	MBT
Silver Metallic Gloss	MSM
Yellow Leaf Gloss	MYL
Copper Red Matte	MCR
Sage Green Matte	MGG
Navy Blue Matte	MNB

**Natural Stone**

White Gray Marble	RWM
-------------------	-----

**Solid Surface ( Wilsonart )**

Black Onyx Mirage	STS-BLS
Hidden Spaces	STS-HIS
Kimberlite	STS-KIS
Yukon Riverstone	STS-YUS

**Wood & Veneer**

Clear over Ash	WCA
Oak Over Ash	WOA
Gray Over Ash	WGA
Walnut Over Ash	WWA
Black Over Ash	WBA
Clear Over Beech	WCB
Oak Over Beech	WOB
Gray Over Beech	WGB
Walnut Over Beech	WWB
Black Over Beech	WBB
Clear Over Walnut	WCW
Navy Painted Wood	WNP

**Painted Wood**

Blood Orange	PBO
Cashew Yellow	PCY
Cream White	PCW
Dusty Pink	PDP
Forest Green	PFG
Ocean Blue	POB
Stone Gray	PSG

**Memo Supported Open-Line Finishes**

**Corian**

Memo offers open line Corian solid surface options on the Prose Collection. For a list of Corian products by grade see page 82.

**Forbo Furniture Linoleum**

Ash - 4132	FAS
Burgundy - 4154	FBU
Iron - 4178	FIR
Pebble - 4175	FPE
Pewter - 4155	FPW
Powder - 4185	FPO
Smokey Blue - 4179	FSB

## Textiles

### Graded-in Textiles

Memo has partnered with Camira, Kvadrat, and Maharam to offer graded-in textiles. All graded-in textiles are listed by Pattern Name on page 77 and by Grading Group on page 78. Our Grading Groups and their LIST prices per yard are outlined below. Published product prices, including the cost of Graded-in Textiles, have been calculated by multiplying by the price per yard figures below by the yardage requirements indicated on a given product page.

Grading Group	LIST Price per Yard
1	48
2	59
3	74
4	84
5	95
6	109
7	126
8	144
9	165
10	193
11	228
12	263
13	315
14	389
15	463

Memo is glad to grade in textiles from suppliers other than Camira, Kvadrat, and Maharam per customer requests. A grading fee of \$200 NET per pattern, per product, will apply in such cases. Please contact us to submit grading requests.

When specifying graded-in textiles the projected completion date of your order may exceed our normal lead times due to constraints of the textile supplier. In such instances, Memo will promptly communicate such delays and advise on adjusted lead times.

Textiles are subject to the quality and shipping standards of the provider. Memo assumes no responsibility for defects, color inaccuracies, shortages, wear, or performance of textiles.

### Ordering a Textile Sample

Samples can be ordered by visiting the textile provider's website.



## Textiles

### Customer's Own Material (COM)

While we recommend selecting from our graded-in Camira, Kvadrat, and Maharam textile offer for the most streamlined process, we also provide the option to use COM. Memo, however, reserves the right to reject textiles which are unsuitable for upholstery on our products. This may be due to inadequate textile weight or unique elastic qualities which impact the integrity of upholstery on our products.

To select fabric outside of the graded-in fabric program, a few steps are required. Memo provides the total yardage for each product on its product spec sheets and pricelist reference pages. These published yardage figures are based on the application conditions of the cutting pattern for each product as well as managing quality issues. Certain textiles, depending on their width and/or repeat, may require additional yardage beyond the figures in our pricing pages. To calculate additional yardage, see our guidelines on page 11. Memo will also provide yardage requirements upon receipt of an order.

Upon receipt of the textile, Memo will immediately advise if flaws or deficiencies in the order are discovered. Memo assumes no responsibility for defects, color inaccuracies, shortages, wear, or sub-standard performance of the specified textiles.

Note that Memo will dispose of excess upholstery material at the time of shipment unless expressly requested to return it with the product shipment.

### Customer's Own Leather (COL)

Please contact our customer service group at [info@memofurniture.com](mailto:info@memofurniture.com) or +1 206 995 8780.

**Textiles****Delivery of Customer's Own Material (COM)**

Customers are responsible for ensuring delivery of COM fabric to Memo. Orders for COM-upholstered products will be scheduled into production upon receipt of all COM and swatches. Please work with our customer service group to procure written confirmation of textile supplier ship dates to ensure the best possible lead time. Since shipment of COM orders depends upon textile availability, lead times may vary.

**When supplying COM textiles to Memo, please include the following info:**

Textile supplier

Pattern name and number

Color name and number

A representative fabric swatch for identification purposes with face side marked

Any nonstandard treatments applied to the fabric

Any additional documentation

**All COM or COL must be sent prepaid to the following address and tagged as follows:**

Kaas Tailored c/o Memo Furniture

13000 Beverly Park Road, Suite A

Mukilteo, WA 98275

Attn: Receiving Department

Dealer name

P.O. #

Order code # (for each fabric)

**Textiles****Order Requirements for Customer's Own Material (COM)**

Memo reserves the right to reject textiles or materials. Textiles requiring secondary backing or coatings should be treated prior to shipping to Memo. All yardage figures listed in Memo product spec sheets and pricelist reference pages are based on at least 54" Wide, Plain Fabric.

**Increases for Textile Width and/or Repeat**

In the event that COM textile is both less than 54" wide and also has a repeat, add both of the two increases shown below. For textiles that require matching (stripes, plaids, prints, pattern repeats) it is Memo's policy to match all pattern repeats, stripes, prints or plaids unless specified 'No Matching Required' on purchase order.

**Fabric Bolts Less than 54" Wide**

Less than 54" wide	Add 08%
Less than 50" wide	Add 13%
Less than 48" wide	Add 20%
Less than 45" wide	Add 50%
Less than 36" wide	Add 60%

**Fabrics with Repeats**

Repeat 7" & less	Add 11%
Repeat 13" & less	Add 18%
Repeat 21" & less	Add 21%
Repeat 27" & less	Add 24%
Repeat more than 27"	Add 25%

**Order Requirements for Customer's Own Leather (COL)**

COL orders are based on an average hide size of 45 square feet of usable leather and 19 feet per yard. Due to shape and quality issues with some leather, additional hides may be required after receipt of COL. Ship full hides only.

To convert COM yardage requirements to COL square footage and number of hides, multiply the COM yardage by 19.

Example: 5 yards x 19 = 95 square feet.

**April**

Side Chair

Designed by Jun Yasumoto, 2022

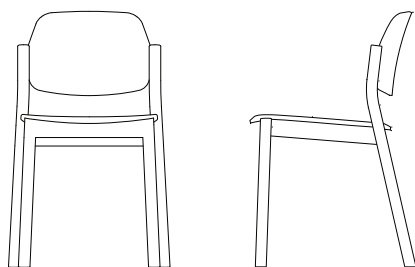

Depth	Width	Height
19.5	19.25	30.75

Core Product	Core Code	List Price
Side Chair - Beech	JY02-10	894

**Standard with Core Product**

Non-marring Glides

Textile Yardage	Seat
Total: .65	.65

**List Price by Textile Grade\***

	COM / 1	2	3	4	5	6	7	8	9	10	11	12	13	14	15
JY02-10-UPH	1192	1199	1209	1216	1223	1232	1243	1255	1268	1286	1308	1332	1366	1414	1462

Options	Code	List Price Add
Upholstered Seat	UPH	See above
Clear Over Beech	WCB	0
Stain Finishes	WGB/WOB/MWB/WBB/WBA	73
Painted Wood	PEW/PCY/PFG/POB/PBO/PSG/PDP	105

**Notes**

For step-by-step specifications and quotes, access our live quote tool online at → [Quotes](#)

**April**

ADA Stool

Designed by Jun Yasumoto, 2022

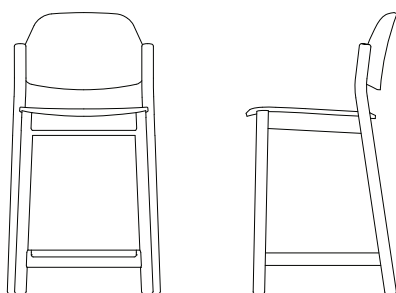

Depth	Width	Height
18	18.5	34

Core Product	Core Code	List Price
ADA Height Stool - Beech	JY02-15	995

**Standard with Core Product**

- Glides
- Stainless Steel Footrail

Textile Yardage	Seat
Total: .65	.65

**List Price by Textile Grade\***

	COM / 1	2	3	4	5	6	7	8	9	10	11	12	13	14	15
JY02-15-UPH	1293	1300	1310	1317	1324	1333	1344	1356	1369	1387	1409	1433	1467	1515	1563

Options	Code	List Price Add
Upholstered Seat	UPH	See above
Clear Over Beech	WCB	0
Stain Finishes	WGB/WOB/WWB/WBB/WBA	83
Painted Wood	PEW/PCY/PFG/POB/PBO/PSG/PDP	113

**Notes**

For step-by-step specifications and quotes, access our live quote tool online at → Quotes

**April**

Counter Stool

Designed by Jun Yasumoto, 2022

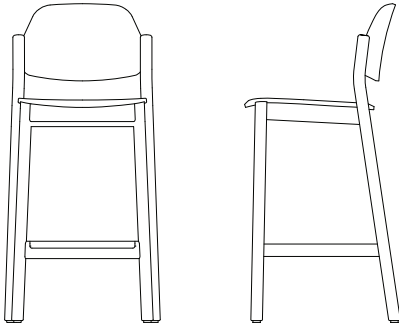

<b>Depth</b>	<b>Width</b>	<b>Height</b>
18	18.5	38

<b>Core Product</b>	<b>Core Code</b>	<b>List Price</b>
Counter Stool - Beech	JY02-16	995

**Standard with Core Product**

- Glides
- Stainless Steel Footrail

<b>Textile Yardage</b>	<b>Seat</b>
Total: .65	.65

**List Price by Textile Grade\***

	COM / 1	2	3	4	5	6	7	8	9	10	11	12	13	14	15
JY02-16-UPH	1293	1300	1310	1317	1324	1333	1344	1356	1369	1387	1409	1433	1467	1515	1563

<b>Options</b>	<b>Code</b>	<b>List Price Add</b>
Upholstered Seat	UPH	See above
Clear Over Beech	WCB	0
Stain Finishes	WGB/WOB/WWB/WBB/WBA	83
Painted Wood	PEW/PCY/PFG/POB/PBO/PSG/PDP	115

**Notes**

For step-by-step specifications and quotes, access our live quote tool online at → [Quotes](#)

**April**

**Bar Stool**

Designed by Jun Yasumoto, 2022

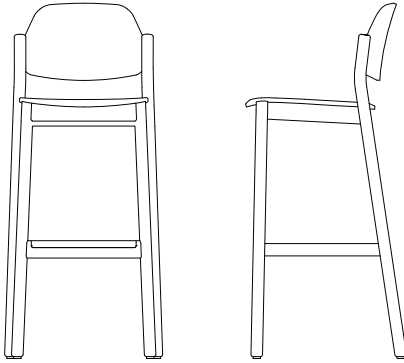

<b>Depth</b>	<b>Width</b>	<b>Height</b>
18	18.75	42.25

<b>Core Product</b>	<b>Core Code</b>	<b>List Price</b>
Bar Stool - Beech	JY02-17	1005

**Standard with Core Product**

- Glides
- Stainless Steel Footrail

<b>Textile Yardage</b>	<b>Seat</b>
Total: .65	.65

**List Price by Textile Grade\***

	COM / 1	2	3	4	5	6	7	8	9	10	11	12	13	14	15
JY02-17-UPH	1303	1310	1320	1327	1334	1343	1354	1366	1379	1397	1419	1443	1477	1525	1573

<b>Options</b>	<b>Code</b>	<b>List Price Add</b>
Upholstered Seat	UPH	See above
Clear over Beech	WCB	0
Stain Finishes	WGB/WOB/WWB/WBB/WBA	83
Painted Wood	PEW/PCY/PFG/POB/PBO/PSG/PDP	115

**Notes**

For step-by-step specifications and quotes, access our live quote tool online at → [Quotes](#)

**April**

Bar Stool with Low Back  
Designed by Jun Yasumoto, 2022

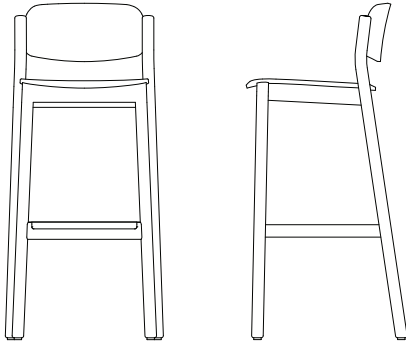

Depth	Width	Height
18	18.75	40.25

Core Product	Core Code	List Price
Bar Stool with Low Back - Beech	JY02-18	1005

Standard with Core Product  
Glides  
Stainless Steel Footrail

Textile Yardage	Seat
Total: .65	.65

List Price by Textile Grade\*

	COM / 1	2	3	4	5	6	7	8	9	10	11	12	13	14	15
JY02-18-UPH	1303	1310	1320	1327	1334	1343	1354	1366	1379	1397	1419	1443	1477	1525	1573

Options	Code	List Price Add
Upholstered Seat	UPH	See above
Clear Over Beech	WCB	0
Stain Finishes	WGB/WOB/MWB/WBB/WBA	83
Painted Wood	PEW/PCY/PFG/POB/PBO/PSG/PDP	116

**Notes**

For step-by-step specifications and quotes, access our live quote tool online at → Quotes



## Chord

Personal Table

Designed by Standard Issue, 2019

Made in the USA.

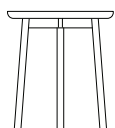
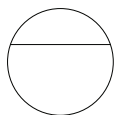

Depth	Width	Height
18"	18"	20.5"

### Core Product

Personal Table

### Core Code

MM01-T1

### List Price

1136

### Standard with Core Product

Glides

Open Tray Surface

Powder Coated Steel Frame

### Options

	Code	List Price Add
<b>Large Insert Options</b>		
Forbo Linoleum	FTL	301
Wood Veneer (Ash)	VAL	384
Clear Finish	WCA/WCW	0
Stain Finish	WOA/WWA/WGA/WNP/WBA	38
Wood Veneer (Walnut)	VWL	438
<b>Small Insert Options</b>		
No Insert (void)	XXS	0
Forbo Linoleum	FTS	9
Wood Veneer (Ash)	VAS	36
Clear Finish	WCA/WCW	0
Stain Finish	WOA/WWA/WGA/WNP/WBA	38
Wood Veneer (Walnut)	VWS	59
Solid Surface		
Yukon Riverstone	STS-YUS	329
Black Onyx Mirage	STS-BLS	329
Hidden Space	STS-HIS	329
Kimberlite	STS-KIS	435

## Specifiable Finishes

Linoleum	Choose from Forbo linoleum products on page 7
Metal	Choose from Memo Metal Powder Coat Finishes on page 7
Wood	Choose from Memo Wood Finishes on page 7
Solid Surface	Choose from Memo Solid Surface Finishes on page 7

## Notes

For step-by-step specifications and quotes, access our live quote tool online at → [Quotes](#)

## Chord

Side Table

Designed by Standard Issue, 2019

Made in the USA.

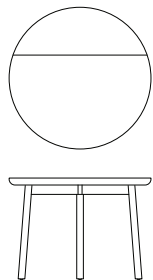

Depth	Width	Height
24"	24"	17.25"

### Core Product

Side Table

### Core Code

MM01-T2

### List Price

1203

### Standard with Core Product

Glides

Open Tray Surface

Powder Coated Steel Frame

### Options

	Code	List Price Add
<b>Large Insert Options</b>		
Forbo Linoleum	FTL	367
Wood Veneer (Ash)	VAL	530
Clear Finish	WCA/WCW	0
Stain Finish	WOA/WWA/WGA/WNP/WBA	57
Wood Veneer (Walnut)	VWL	620
<b>Small Insert Options</b>		
No Insert (void)	XXS	0
Forbo Linoleum	FTS	8
Wood Veneer (Ash)	VAS	26
Clear Finish	WCA/WCW	0
Stain Finish	WOA/WWA/WGA/WNP/WBA	57
Wood Veneer (Walnut)	VWS	53
<b>Solid Surface</b>		
Yukon Riverstone	STS-YUS	407
Black Onyx Mirage	STS-BLS	407
Hidden Space	STS-HIS	407
Kimberlite	STS-KIS	559

## Specifiable Finishes

Linoleum	Choose from Forbo linoleum products on page 7
Metal	Choose from Memo Metal Powder Coat Finishes on page 7
Wood	Choose from Memo Wood Finishes on page 7
Solid Surface	Choose from Memo Solid Surface Finishes on page 7

## Notes

For step-by-step specifications and quotes, access our live quote tool online at → [Quotes](#)

**Chord**

Coffee Table

Designed by Standard Issue, 2019

Made in the USA.

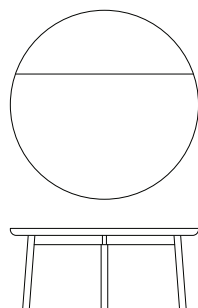

<b>Depth</b>	<b>Width</b>	<b>Height</b>
32"	32"	14.25"

**Core Product**

Coffee Table

**Core Code**

MM01-T3

**List Price**

1363

**Standard with Core Product**

Glides

Open Tray Surface

Powder Coated Steel Frame

**Options**

	Code	List Price Add
<b>Large Insert Options</b>		
Forbo Linoleum	FTL	464
Wood Veneer (Ash)	VAL	722
Clear Finish	WCA/WCW	0
Stain Finish	WOA/WWA/WGA/WNP/WBA	76
Wood Veneer (Walnut)	VWL	857
<b>Small Insert Options</b>		
No Insert (void)	XXS	0
Forbo Linoleum	FTS	36
Wood Veneer (Ash)	VAS	50
Clear Finish	WCA/WCW	0
Stain Finish	WOA/WWA/WGA/WNP/WBA	76
Wood Veneer (Walnut)	VWS	85
Solid Surface		
Yukon Riverstone	STS-YUS	634
Black Onyx Mirage	STS-BLS	634
Hidden Space	STS-HIS	634
Kimberlite	STS-KIS	900

## Specifiable Finishes

Linoleum	Choose from Forbo linoleum products on page 7
Metal	Choose from Memo Metal Powder Coat Finishes on page 7
Wood	Choose from Memo Wood Finishes on page 7
Solid Surface	Choose from Memo Solid Surface Finishes on page 7

## Notes

For step-by-step specifications and quotes, access our live quote tool online at → [Quotes](#)

**Chroma**

Lounge

Designed by Harri Koskinen, 2019

Made in the USA.

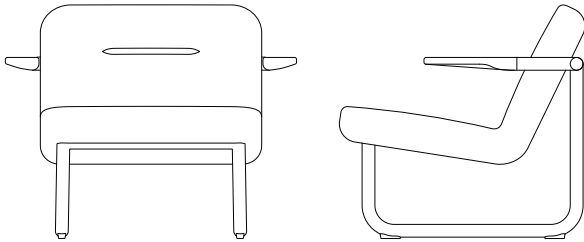

Depth	Width	Height
28.75"	33.75"	27.5"

**Core Product**

Lounge

**Core Code**

HK01-01

**Textile Yardage**

Total: 2.0

**Seat Back Arms**

n/a n/a n/a

**List Price by Textile Grade**

	COM / 1	2	3	4	5	6	7	8	9	10	11	12	13	14	15
HK01-01	3269	3291	3321	3341	3363	3391	3425	3461	3503	3559	3625	3699	3803	3951	4099

**Standard with Core Product**

Ash Arms

Non-Marring Glides

High Resilience Polyurethane Foam

**Options**

Component	Code	List Price Add
Ash Arms with Stain	WOA/WBA	21
	WWA	56
	WGA/WNP/WBA	91
Walnut Arms	WCW	294

**Specifiable Finishes**

Metal Choose from Memo Metal Powder Coat Finishes on page 7

Textiles Choose from Camira, Maharam, or Kvadrat textiles on page 80, or contact Memo for assistance with COM fabrics

Wood Choose from Memo Wood Finishes on page 7

**Notes**

Due to the continuous seat and back, multiple textiles are not permitted on Chroma Lounge

For step-by-step specifications and quotes, access our live quote tool online at → Quotes

**Chroma**

Lounge, Armless

Designed by Harri Koskinen, 2019

Made in the USA.

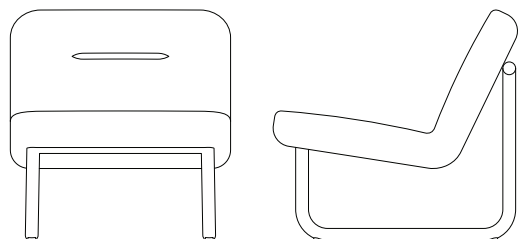

Depth	Width	Height
28.75"	26"	27.5"

**Core Product**

Lounge, Armless

**Core Code**

HK01-09

**Textile Yardage**

Total: 2.0

Seat	Back	Arms
n/a	n/a	n/a

**List Price by Textile Grade**

	COM / 1	2	3	4	5	6	7	8	9	10	11	12	13	14	15
HK01-09	2699	2721	2751	2771	2793	2821	2855	2891	2933	2989	3055	3129	3233	3381	3529

**Standard with Core Product**

Non-Marring Glides

High Resilience Polyurethane Foam

**Specifiable Finishes**

Metal

Choose from Memo Metal Powder Coat Finishes on page 7

Textiles

Choose from Camira, Maharam, or Kvadrat textiles on page 80, or contact Memo for assistance with COM fabrics

**Notes**

Due to the continuous seat and back, multiple textiles are not permitted on Chroma Lounge

For step-by-step specifications and quotes, access our live quote tool online at → Quotes



**Chroma**

Lounge, Swivel

Designed by Harri Koskinen, 2019

Made in the USA.

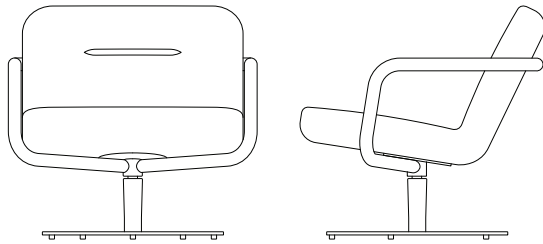

Depth	Width	Height
28.75"	29.25"	27.5"

**Core Product**

Lounge, Swivel

**Core Code**

HK01-11

**Textile Yardage**

Total: 2.0

**Seat Back Arms**

n/a n/a n/a

**List Price by Textile Grade**

	COM / 1	2	3	4	5	6	7	8	9	10	11	12	13	14	15
HK01-11	3678	3700	3730	3750	3772	3800	3834	3870	3912	3968	4034	4108	4212	4360	4508

**Standard with Core Product**

Free swivel base

High Resilience Polyurethane Foam

Non-Marring Glides

**Specifiable Finishes**

Metal Choose from Memo Metal Powder Coat Finishes on page 7

Textiles Choose from Camira, Maharam, or Kvadrat textiles on page 80, or contact Memo for assistance with COM fabrics

**Notes**

Due to the continuous seat and back, multiple textiles are not permitted on Chroma Lounge

For step-by-step specifications and quotes, access our live quote tool online at → Quotes

**Chroma**

Ottoman - 17

Designed by Harri Koskinen, 2019

Made in the USA.

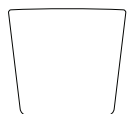
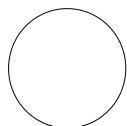

Depth	Width	Height
17.25"	17.25"	15.5"

**Core Product**

Ottoman

**Core Code**

HK01-00

Textile Yardage	Seat	Back	Arms
Total: 1.25	1.25	n/a	n/a

**List Price by Textile Grade**

	COM / 1	2	3	4	5	6	7	8	9	10	11	12	13	14	15
HK01-00	1050	1064	1083	1095	1109	1126	1148	1170	1196	1231	1273	1319	1384	1476	1569

**Standard with Core Product**

High Resilience Polyurethane Foam

Non-Marring Glides

**Specifiable Finishes**

Textiles Choose from Camira, Maharam, or Kvadrat textiles on page 80, or contact Memo for assistance with COM fabrics

**Notes**

For step-by-step specifications and quotes, access our live quote tool online at → Quotes

**Chroma**

Ottoman - 24

Designed by Harri Koskinen, 2019

Made in the USA.

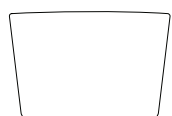
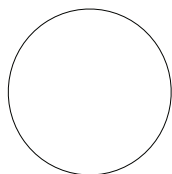

Depth	Width	Height
24"	24"	15.5"

**Core Product**

Ottoman

**Core Code**

HK01-24

Textile Yardage	Seat	Back	Arms
Total: 1.5	1.5	n/a	n/a

**List Price by Textile Grade**

	COM / 1	2	3	4	5	6	7	8	9	10	11	12	13	14	15
HK01-24	1372	1389	1411	1426	1443	1464	1489	1516	1548	1590	1639	1695	1773	1884	1995

**Standard with Core Product**

High Resilience Polyurethane Foam

Non-Marring Glides

**Specifiable Finishes**

Textiles Choose from Camira, Maharam, or Kvadrat textiles on page 80, or contact Memo for assistance with COM fabrics

**Notes**

For step-by-step specifications and quotes, access our live quote tool online at → [Quotes](#)

**Chroma**

Ottoman - 29

Designed by Harri Koskinen, 2019

Made in the USA.

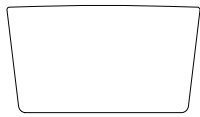
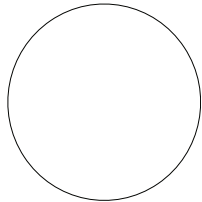

Depth	Width	Height
29"	29"	15.5"

**Core Product**

Ottoman

**Core Code**

HK01-29

**Textile Yardage**

Total: 2

Seat	Back	Arms
2	n/a	n/a

**List Price by Textile Grade**

	COM / 1	2	3	4	5	6	7	8	9	10	11	12	13	14	15
HK01-29	1585	1607	1637	1657	1679	1707	1741	1777	1819	1875	1941	2015	2119	2267	2415

**Standard with Core Product**

High Resilience Polyurethane Foam

Non-Marring Glides

**Specifiable Finishes**

Textiles

Choose from Camira, Maharam, or Kvadrat textiles on page 80, or contact Memo for assistance with COM fabrics

**Notes**

For step-by-step specifications and quotes, access our live quote tool online at → Quotes

**Chroma**

Ottoman - 38

Designed by Harri Koskinen, 2019

Made in the USA.

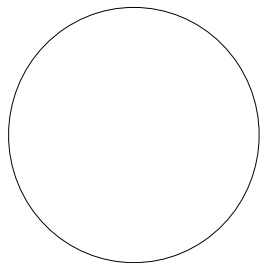

Depth	Width	Height
38"	38"	15.5"

**Core Product**

Ottoman

**Core Code**

HK01-38

**Textile Yardage**

Total: 2.25

**Seat Back Arms**

2.25 n/a n/a

**List Price by Textile Grade**

	COM / 1	2	3	4	5	6	7	8	9	10	11	12	13	14	15
HK01-38	2066	2091	2125	2147	2172	2203	2242	2282	2329	2392	2467	2550	2667	2833	3000

**Standard with Core Product**

High Resilience Polyurethane Foam

Non-Marring Glides

**Specifiable Finishes**

Textiles Choose from Camira, Maharam, or Kvadrat textiles on page 80, or contact Memo for assistance with COM fabrics

**Notes**

For step-by-step specifications and quotes, access our live quote tool online at → Quotes

**Ida**

Table

Designed by Nina Cho, 2022

Made in the USA.

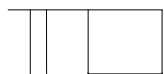
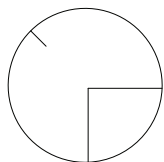

Depth	Width	Height
32"	32"	13.75"

**Core Product**

Table

**Core Code**

NC01-T1

**List Price**

5676

**Options**

	Code	List Price Add
<b>Shelf Insert Options</b>		
No Shelf Insert	XXS	0
Solid Wood Insert (Ash)	WAS	279
Solid Wood Insert (Ash + Stain) WOA/WWA/WGA/WNP/WBA		93
Solid Wood Insert (Walnut)	WWS	434
Stone Insert (Marble)	STS	825

**Specifiable Finishes**

Metal	Choose from Memo Metal Powder Coat Finishes on page 7
Wood (shelf)	Choose from Memo Wood Finishes on page 7

**Notes**

For step-by-step specifications and quotes, access our live quote tool online at → [Quotes](#)

**Kino**

Stool

Designed by Kensaku Oshiro, 2020

Made in the Canada, Assembled in the USA.

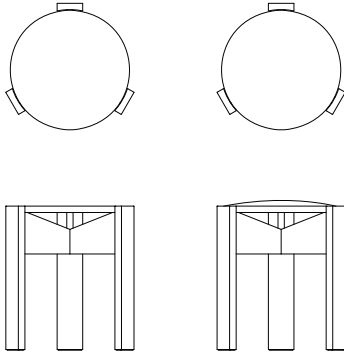

Depth	Width	Height
15.75"	15.75"	17.75 / 18.25"

Core Product	Core Code	List Price
Stool - Ash	KN01-S1-A	587
Stool - Walnut	KN01-S1-W	787

**Standard with Core Product**

- Glides
- Solid Wood Frame
- Solid Wood Top

Textile Yardage	Seat
Total: .6	.6

**List Price by Textile Grade\***

	COM / 1	2	3	4	5	6	7	8	9	10	11	12	13	14	15
KN01-S1-A-UTT	816	822	831	837	844	852	863	873	886	903	923	945	976	1020	1065
KN01-S1-W-UTT	1024	1030	1039	1045	1052	1060	1071	1081	1094	1111	1131	1153	1184	1228	1273

**Standard with Core Product**

- Non-Marring Glides
- High Resilience Polyurethane Foam

Options and Notes overleaf

**Options**

	<b>Code</b>	<b>List Price Add</b>
Upholstered Top	UTT	See previous page
Clear Finish (by species)	WCA	0
Stain Finish - Wood Top	WOA/WBA	27
	WWA	44
	WGA/WNP	71
Stain Finish - Upholstered Top	WOA/WBA	27
	WWA	44
	WGA/WNP	71

**Specifiable Finishes**

- Wood Choose from Memo Wood Finishes on Page 7
- Textiles Choose from Camira, Maharam, or Kvadrat textiles on page 80, or contact Memo for assistance with COM fabrics

**Notes**

For step-by-step specifications and quotes, access our live quote tool online at → [Quotes](#)



**Maru Benches**

Three Slat Bench - 3/4-Length  
Designed by Studio Gorm, 2020  
Made in the USA.



Depth      Width      Height  
17.75"      65.5"      17"

**Core Product**

Three Slat Bench - 3/4-Length - Ash

**Core Code**

SG03-IND-S3-66W-A

**Standard with Core Product**

Glides  
Solid Ash Wood Frame

**Upholstery Configurations**

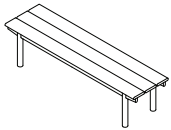

Configuration 1.3-S  
(none)

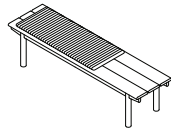

Configuration 2.3-S  
-PC2

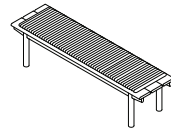

Configuration 3.3-S  
-P60D2

**Textile Yardage**

Pad, Long (60"):    2.75    (each)  
Pad, Standard:      1.50    (each)

**Upholstery Configurations - List Price by Textile Grade**

	Base	COM / 1	2	3	4	5	6	7	8	9	10	11	12	13	14	15
Configuration 1.3-S	2759	n/a	n/a	n/a	n/a	n/a	n/a	n/a	n/a	n/a	n/a	n/a	n/a	n/a	n/a	n/a
Configuration 2.3-S		3401	3418	3440	3455	3472	3493	3518	3545	3577	3619	3668	3724	3802	3913	4024
Configuration 3.3-S		3563	3585	3615	3635	3657	3685	3719	3755	3797	3853	3919	3993	4097	4245	4393

Options and Notes overleaf

**Options**

Wood Species	Code	List Price Add
Ash	A	0
Walnut	W	1694

**Wood Finishes**

Clear over Ash/Walnut	WCA/WCW	0
Ash with Stain Finish	WOA/WWA	125

**Accessories** (see below for visuals)

Table, Round, Ash Veneer	T1	527
Table, Obround, Ash Veneer	T2	580
Power Module/s	PM1/PM2	350/805

**Other Options**

Veneer Round Table Top(s), Walnut	VTW	85 (per table)
Veneer Obround Table Top(s), Walnut	VTW	94 (per table)
Veneer Round Table Top(s), Ash with Stain	WOA/WWA	53 (per table)
Veneer Obround Table Top(s), Ash with Stain	WOA/WWA	58 (per table)

**Specifiable Finishes**

Textiles Choose from Maharam, Kvadrat, or Camira textiles on page 80, contact Memo for assistance with COM fabrics  
 Wood/Veneer Choose from Memo Wood Finishes on page 7

**Notes**

For step-by-step specifications and quotes, access our live quote tool online at → Quotes

**Accessories (visuals)**

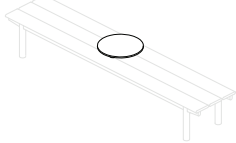

Table, Round  
See below for locations

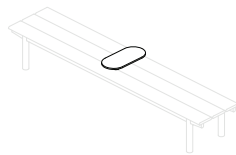

Table, Obround  
See below for locations

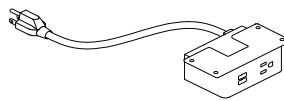

Power Module  
1-Power, 2-USB

**Table Locations** (Round Table shown)

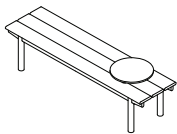

-T1F2  
For Configurations 1.3-S

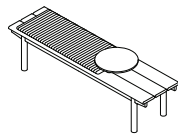

-T1E2  
For Configuration 2.3-S

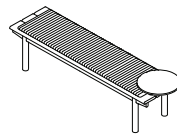

-T1G2  
For Configuration 3.3-S

**Maru Benches**

Three Slat Bench

Designed by Studio Gorm, 2020

Made in the USA.



<b>Depth</b>	<b>Width</b>	<b>Height</b>
17.75"	85.5"	17"

**Core Product**

Three Slat Bench - Ash

**Core Code**

SG03-IND-S3-86W-A

**Standard with Core Product**

Glides

Solid Ash Wood Frame

**Upholstery Configurations**

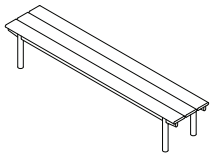

Configuration 1.3  
(none)

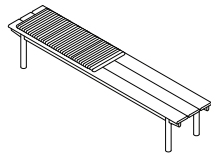

Configuration 2.3  
-PC2

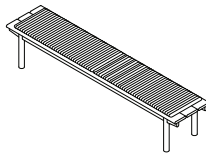

Configuration 3.3  
-PC2-PG2

**Textile Yardage**

Pad: 1.50 (each)

**Upholstery Configurations - List Price by Textile Grade**

	Base	COM / 1	2	3	4	5	6	7	8	9	10	11	12	13	14	15
Configuration 1.3	3343	n/a	n/a	n/a	n/a	n/a	n/a	n/a	n/a	n/a	n/a	n/a	n/a	n/a	n/a	n/a
Configuration 2.3		3985	4002	4024	4039	4056	4077	4102	4129	4161	4203	4252	4308	4386	4497	4608
Configuration 3.3		4627	4660	4705	4735	4768	4810	4861	4915	4978	5062	5161	5272	5428	5650	5872

Options and Notes overleaf

**Options**

Wood Species	Code	List Price Add
Ash	A	0
Walnut	W	1764

**Wood Finishes**

Clear over Ash/Walnut	WCA/WCW	0
Ash with Stain Finish	WOA/WWA	149

**Accessories** (see below for visuals)

Table, Round, Ash Veneer	T1	527
Table, Obround, Ash Veneer	T2	580
Power Module/s	PM1/PM2	350/805

**Other Options**

Veneer Round Table Top(s), Walnut	VTW	85 (per table)
Veneer Obround Table Top(s), Walnut	VTW	94 (per table)
Veneer Round Table Top(s), Ash with Stain	WOA/WWA	53 (per table)
Veneer Obround Table Top(s), Ash with Stain	WOA/WWA	58 (per table)

**Specifiable Finishes**

Textiles Choose from Maharam, Kvadrat, or Camira textiles on page 80, contact Memo for assistance with COM fabrics  
 Wood/Veneer Choose from Memo Wood Finishes on page 7

**Notes**

For step-by-step specifications and quotes, access our live quote tool online at → [Quotes](#)

**Accessories (visuals)**

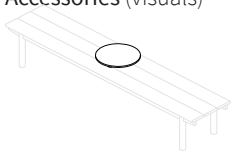

Table, Round  
See below for locations

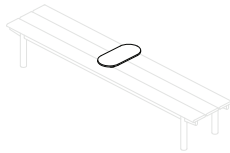

Table, Obround  
See below for locations

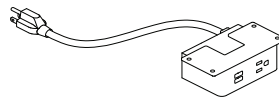

Power Module  
1-Power, 2-USB

**Table Locations (Round Table shown)**

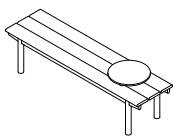

-T1F2  
For Configurations 1.3-S

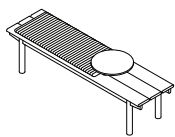

-T1E2  
For Configuration 2.3-S

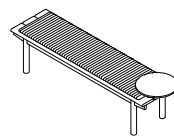

-T1G2  
For Configuration 3.3-S

**Maru Benches**

Five Slat Bench

Designed by Studio Gorm, 2020

Made in the USA.

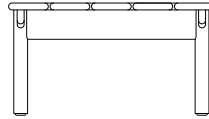

Depth	Width	Height
29.75"	85.5"	17"

**Core Product**

Five Slat Bench -Ash

**Core Code**

SG03-IND-S5-86W-A

**Standard with Core Product**

Glides

Solid Ash Wood Frame

**Upholstery Configurations**

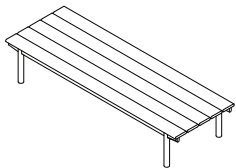

Configuration 1.5  
(none)

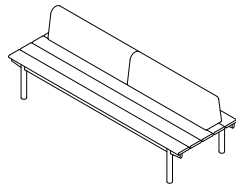

Configuration 2.5  
-BC2-BG2

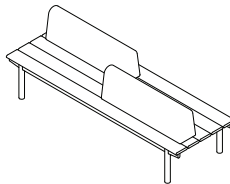

Configuration 3.5  
-BC2-BG4

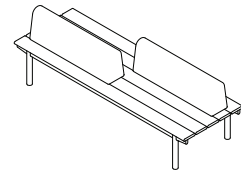

Configuration 4.5  
-BC4-BG2

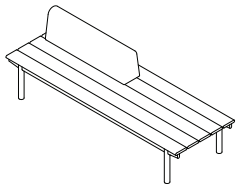

Configuration 5.5  
-BC2

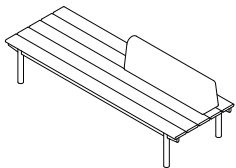

Configuration 6.5  
-BG2

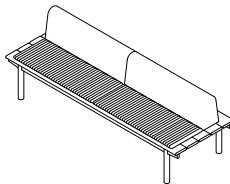

Configuration 7.5  
-BC2-BG2-PC4-PG4

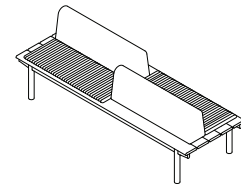

Configuration 8.5  
-BC2-BG4-PC4-PG2

More Configurations, Pricing, Options, and Notes overleaf

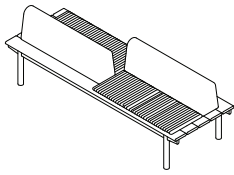

Configuration 9.5  
-BG4-BG2-PC2-PG4

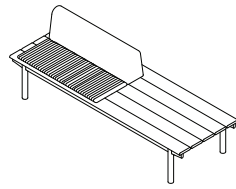

Configuration 10.5  
-BC2-PC4

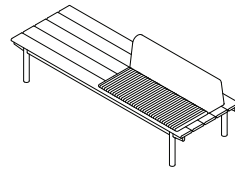

Configuration 11.5  
-BG2-PG4

**Textile Yardage**

Bolster: 1.25 (each)  
Pad: 2.75 (each)

**Upholstery Configurations - List Price by Textile Grade\***

	Base	COM / 1	2	3	4	5	6	7	8	9	10	11	12	13	14	15
Configuration 1.5	4679	n/a	n/a	n/a	n/a	n/a	n/a	n/a	n/a	n/a	n/a	n/a	n/a	n/a	n/a	n/a
Configuration 2.5	6003	6031	6068	6093	6121	6156	6198	6243	6296	6366	6448	6541	6671	6856	7041	
Configuration 3.5	6003	6031	6068	6093	6121	6156	6198	6243	6296	6366	6448	6541	6671	6856	7041	
Configuration 4.5	6003	6031	6068	6093	6121	6156	6198	6243	6296	6366	6448	6541	6671	6856	7041	
Configuration 5.5	5341	5355	5374	5386	5400	5417	5439	5461	5487	5522	5564	5610	5675	5767	5860	
Configuration 6.5	5341	5355	5374	5386	5400	5417	5439	5461	5487	5522	5564	5610	5675	5767	5860	
Configuration 7.5	7287	7348	7430	7485	7546	7623	7716	7815	7931	8085	8266	8470	8756	9163	9570	
Configuration 8.5	7287	7348	7430	7485	7546	7623	7716	7815	7931	8085	8266	8470	8756	9163	9570	
Configuration 9.5	7287	7348	7430	7485	7546	7623	7716	7815	7931	8085	8266	8470	8756	9163	9570	
Configuration 10.5	5983	6013	6055	6082	6112	6151	6198	6247	6305	6382	6473	6574	6717	6921	7124	
Configuration 11.5	5983	6013	6055	6082	6112	6151	6198	6247	6305	6382	6473	6574	6717	6921	7124	

\*Pricing assumes single textile selection for pads and bolsters. For multiple textiles please visit → Quotes

**Options**

Wood Species	Code	List Price Add
Ash	A	0
Walnut	W	2349

Wood Finishes	Code	List Price Add
Clear over Ash/Walnut	WCA/WCW	0
Ash with Stain Finish	WOA/WWA	215

Accessories (see below for visuals)	Code	List Price Add
Dowel Partition, Ash	SCR1A	3053
Dowel Partition, Ash with Stain Finish	WOA/WWA	600
Table, Round, Ash Veneer	T1	527
Table, Obround, Ash Veneer	T2	580
Power Module/s	PM1/PM2	350/805

More Options, Visuals, and Notes overleaf

**Other Options**

Veneer Round Table Top(s), Walnut	VTW	85 (per table)
Veneer Obround Table Top(s), Walnut	VTW	94 (per table)
Veneer Round Table Top(s), Ash with Stain	WOA/WWA	53 (per table)
Veneer Obround Table Top(s), Ash with Stain	WOA/WWA	58 (per table)

**Specifiable Finishes**

Textiles Choose from Maharam, Kvadrat, or Camira textiles on page 80, contact Memo for assistance with COM fabrics  
 Wood/Veneer Choose from Memo Wood Finishes on page 7

**Notes**

For step-by-step specifications and quotes, access our live quote tool online at → [Quotes](#)

**Accessories (visuals)**

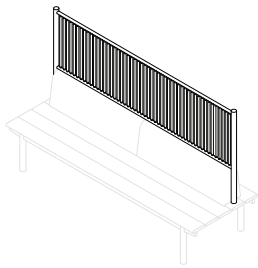

Dowel Partition  
Only for Configurations 2.5, 7.5

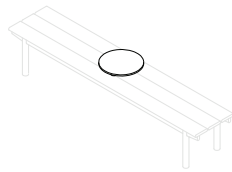

Table, Round  
See below for locations

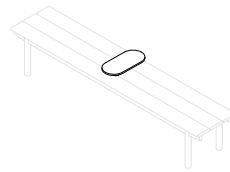

Table, Obround  
See below for locations

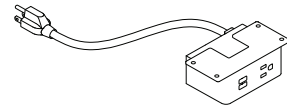

Power Module  
1-Power, 2-USB

**Table Locations (Round Table shown)**

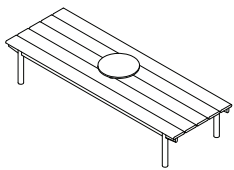

-T1E3  
For Configuration 1.5

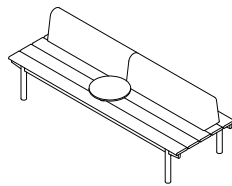

-T1E4  
For Configurations 2.5, 5.5, 6.5, 7.5, 10.5, 11.5

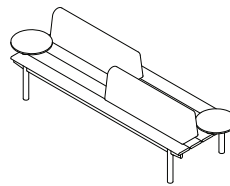

-T1A4-T1I2  
For Configuration 3.5, 8.5

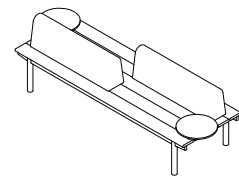

-T1A2-T1I4  
For Configuration 4.5, 9.5

**Maru Benches**

Seven Slat Bench

Designed by Studio Gorm, 2020

Made in the USA.

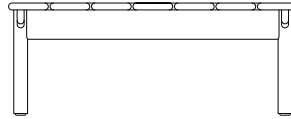

Depth	Width	Height
41.75"	85.5"	17"

**Core Product**

Seven Slat Bench - Ash

**Core Code**

SG03-IND-S7-86W-A

**Standard with Core Product**

Glides

Solid Ash Wood Frame

**Upholstery Configurations**

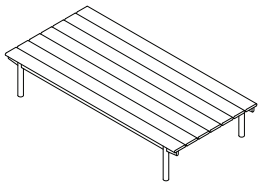

Configuration 1.7  
(none)

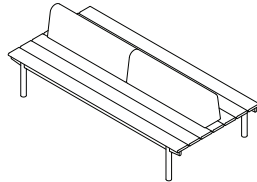

Configuration 2.7  
-BC4-BG4

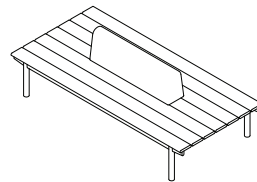

Configuration 3.7  
-BE4

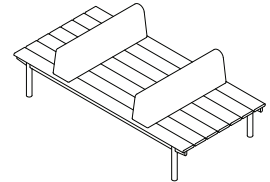

Configuration 4.7  
-BC4R-BG4R

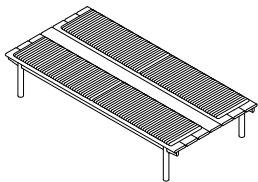

Configuration 5.7  
-PC2-PC6-PG2-PG6

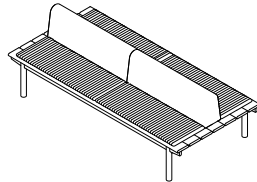

Configuration 6.7  
-BC4-BG4-PC2-PC6-PG2-PG6

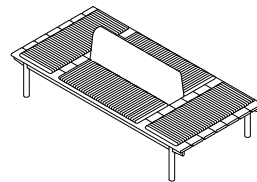

Configuration 7.7  
-BE4-PB4R-PE2-PE6-PH4R

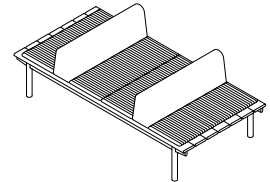

Configuration 8.7  
-BC4R-BG4R-PB4R-PD4R-PF4R-PH4R

Pricing, Options, and Notes overleaf



**Textile Yardage**

Bolster: 1.25 (each)  
Pad: 2.75 (each)

**Upholstery Configurations - List Price by Textile Grade\***

	Base	COM / 1	2	3	4	5	6	7	8	9	10	11	12	13	14	15
Configuration 1.7	6142	n/a	n/a	n/a	n/a	n/a	n/a	n/a	n/a	n/a	n/a	n/a	n/a	n/a	n/a	n/a
Configuration 2.7		7652	7680	7717	7742	7770	7805	7847	7892	7945	8015	8097	8190	8320	8505	8690
Configuration 3.7		6990	7004	7023	7035	7049	7066	7088	7110	7136	7171	7213	7259	7324	7416	7509
Configuration 4.7		7652	7680	7717	7742	7770	7805	7847	7892	7945	8015	8097	8190	8320	8505	8690
Configuration 5.7		8896	8962	9052	9112	9178	9262	9364	9472	9598	9766	9964	10186	10498	10942	11386
Configuration 6.7		10220	10314	10441	10526	10620	10739	10883	11036	11215	11453	11733	12048	12490	13119	13748
Configuration 7.7		9558	9638	9747	9819	9899	10000	10124	10254	10406	10609	10849	11117	11494	12030	12567
Configuration 8.7		10220	10314	10441	10526	10620	10739	10883	11036	11215	11453	11733	12048	12490	13119	13748

\*Pricing assumes single textile selection for pads and bolsters. For multiple textiles please visit → Quotes

**Options**

Wood Species	Code	List Price Add
Ash	A	0
Walnut	W	3386

**Wood Finishes**

Clear over Ash/Walnut	WCA/WCW	0
Ash with Stain Finish	WOA/WWA	294

**Accessories** (see following page for visuals)

Dowel Partition, Ash	SCR1A	3053
Dowel Partition, Ash with Stain Finish	WOA/WWA	600
Table, Round, Ash Veneer	T1	527
Table, Obround, Ash Veneer	T2	580
Power Module/s	PM1/PM2	305/805

**Other Options**

	Code	List Price Add
Veneer Round Table Top(s), Walnut	VTW	85 (per table)
Veneer Obround Table Top(s), Walnut	VTW	94 (per table)
Veneer Round Table Top(s), Ash with Stain	WOA/WWA	53 (per table)
Veneer Obround Table Top(s), Ash with Stain	WOA/WWA	58 (per table)

More Options, Visuals, and Notes overleaf

**Specifiable Finishes**

Textiles

Choose from Maharam, Kvadrat, or Camira textiles on page 80, contact Memo for assistance with COM fabrics

Wood/Veneer

Choose from Memo Wood Finishes on page 7

**Notes**

For step-by-step specifications and quotes, access our live quote tool online at → [Quotes](#)

**Accessories (visuals)**

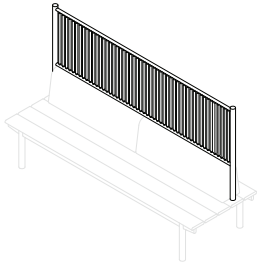

**Dowel Partition**  
Only for Configurations 2.7, 6.7

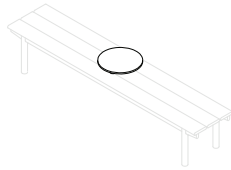

**Table, Round**  
See below for locations

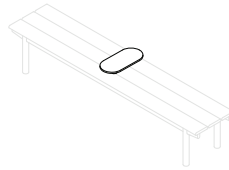

**Table, Obround**  
See below for locations

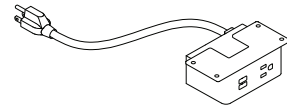

**Power Module**  
1-Power, 2-USB

**Table Locations (Round Table shown)**

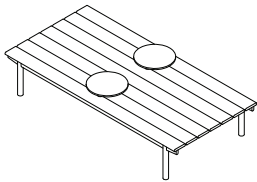

**-T1E2-T1E6**  
For Configurations 1.7, 5.7

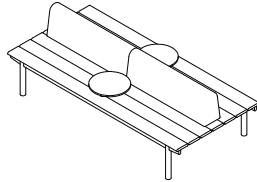

**-T1E2-T1E6**  
For Configurations 2.7, 6.7

**Orca**

Vertical Screen

Designed by Alex Brokamp , 2020

Made in the USA.

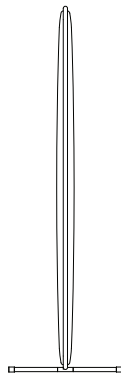
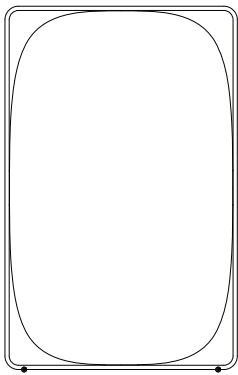
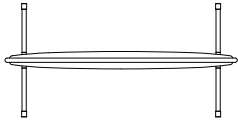

Depth	Width	Height
20"	40.9"	64.3"

**Core Product**

Vertical Screen

**Core Code**

AB01-V

**List Price by Textile Grade\***

	COM / 1	2	<b>3</b>	4	<b>5</b>	6	<b>7</b>	<b>8</b>	9	<b>10</b>	11	12	13	14	15
AB01-V	1859	1900	1957	1994	2035	2088	2152	2219	2298	2403	2527	2665	2860	3138	3415

\*Pricing assumes a single textile selection for both sides. For multiple textiles please visit → Quotes

**Textiles**

AB01 screens are available in select textiles that meet ASTM-E84 Class A Unadhered Testing and are suitable for panel applications.

Choose From:

Camira Quest ( Group 3 )

Kvadrat Remix (Group 8)

Maharam Murmur (Group 5)

Camira Blaze (Group 7)

Kvadrat Melange Nap (Group 10)

Maharam Flock (Group 8)

**Textile Yardage**

Total: 3.75

**Side A**

1.875

**Side B**

1.875

**Standard with Core Product**

Steel Frame with Black Powdercoat

Upholstered Field

Non-marring glides

**Options**

Component	Code	List Price Add
Multiple Textiles (Side A / Side B)	TA	140
Casters	CA	84

**Specifiable Finishes**

Textiles Choose from Camira, Maharam, or Kvadrat textiles on previous page

**Notes**

Multiple Textile option allows for separate textiles on each side  
For step-by-step specifications and quotes, access our live quote tool online at → [Quotes](#)

**Orca**

Horizontal Screen

Designed by Alex Brokamp , 2020

Made in the USA.

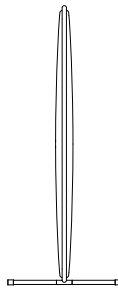
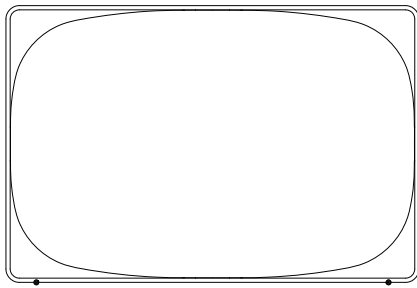
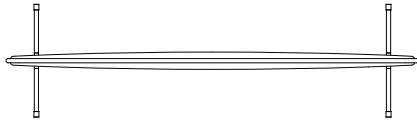

Depth	Width	Height
20"	72.9"	49.3"

**Core Product**

Horizontal Screen

**Core Code**

AB01-H

List Price by Textile Grade\*

	COM / 1	2	3	4	5	6	7	8	9	10	11	12	13	14	15
AB01-H	2054	2101	2165	2207	2254	2313	2386	2462	2551	2670	2811	2968	3189	3503	3818

**Textiles**

AB01 screens are available in select textiles that meet ASTM-E84 Class A Unadhered Testing and are suitable for panel applications.

Choose From:

Camira Quest ( Group 3 )

Kvadrat Remix (Group 8)

Maharam Murmur (Group 5)

Camira Blaze (Group 7)

Kvadrat Melange Nap (Group 10)

Maharam Flock (Group 8)

\*Pricing assumes a single textile selection for both sides. For multiple textiles please visit → Quotes

**Textile Yardage**

Side A    Side B

Total: 4.25

2.125

2.125

**Standard with Core Product**

Steel Frame with Black Powdercoat

Upholstered Field

Non-marring glides

**Options**

Component	Code	List Price Add
Multiple Textiles (Side A / Side B)	TA	140
Casters	CA	84

**Specifiable Finishes**

Textiles Choose from Camira, Maharam, or Kvadrat textiles on previous page

**Notes**

Multiple Textile option allows for separate textiles on each side

For step-by-step specifications and quotes, access our live quote tool online at → [Quotes](#)

**Penna**

Lounge

Designed by Studio Gorm, 2019

Made in the USA.

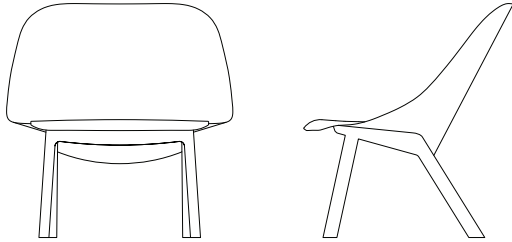

<b>Depth</b>	<b>Width</b>	<b>Height</b>
32"	25.5"	30"

**Core Product**

Lounge - Ash  
Lounge - Walnut

**Core Code**

SG01-01-A  
SG01-01-W

**Textile Yardage**

Total: 2.5

<b>Seat</b>	<b>Back</b>	<b>Arms</b>
.75	1.75	n/a

**List Price by Textile Grade\***

	<b>COM / 1</b>	<b>2</b>	<b>3</b>	<b>4</b>	<b>5</b>	<b>6</b>	<b>7</b>	<b>8</b>	<b>9</b>	<b>10</b>	<b>11</b>	<b>12</b>	<b>13</b>	<b>14</b>	<b>15</b>
SG01-01-A	2698	2726	2763	2788	2816	2851	2893	2938	2991	3061	3143	3236	3366	3551	3736
SG01-01-W	3979	4007	4044	4069	4097	4132	4174	4219	4272	4342	4424	4517	4647	4832	5017

\*Pricing assumes a single textile selection for seat and back. For multiple textiles please visit → Quotes

**Standard with Core Product**

Non-Marring Glides  
High Resilience Polyurethane Foam

**Options**

<b>Component</b>	<b>Code</b>	<b>List Price Add</b>
Multiple Textiles (Seat/Back)	TA	140
Stain Finish on Base	WOA/WBA	54
	WWA	90
	WGA/WNP	126

**Specifiable Finishes**

Textiles Choose from Camira, Maharam, or Kvadrat textiles on page 80, or contact Memo for assistance with COM fabrics  
Wood Choose from Memo Wood Finishes on page 7

**Notes**

Multiple Textile option allows for separate seat and back textiles  
For step-by-step specifications and quotes, access our live quote tool online at → Quotes

**Penna**

Large Round Table

Designed by Studio Gorm, 2019

Made in the USA.

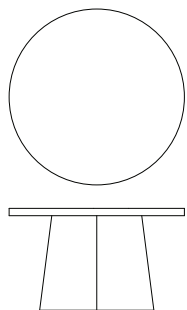

Depth	Width	Height
30"	30"	17.5"

Core Product	Core Code	List Price
Large Round Table - Ash	SG01-T1-A	2255
Large Round Table - Walnut	SG01-T1-W	2459

**Standard with Core Product**

- Glides
- Forbo Linoleum Top
- Solid Wood Edge Band (finish to match base)
- Wood Veneer Base

**Options**

Component	Code	List Price Add
Forbo Linoleum Top	FTT	0
Wood Veneer Top (Ash)	VTA	171
Wood Veneer Top (Walnut)	VTW	257
Ash with Stain Finish	WOA/WBA	95
	WWA	110
	WGA/WNP	125
Power Module (2-power, 2-USB)	PM1	343

**Specifiable Finishes**

- Linoleum Choose from Forbo linoleum products on page 7
- Wood Choose from Memo Wood Finishes on page 7

**Notes**

For step-by-step specifications and quotes, access our live quote tool online at → Quotes



**Penna**

Obround Table

Designed by Studio Gorm, 2019

Made in the USA.

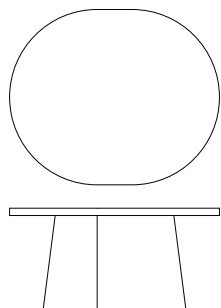

Depth	Width	Height
30"	36"	17.5"

Core Product	Core Code	List Price
Obround Table - Ash	SG01-T2-A	2407
Obround Table - Walnut	SG01-T2-W	2632

**Standard with Core Product**

Glides

Forbo Linoleum Top

Solid Wood Edge Band (finish to match base)

Wood Veneer Base

**Options**

Component	Code	List Price Add
Forbo Linoleum Top	FTT	0
Wood Veneer Top (Ash)	VTA	153
Wood Veneer Top (Walnut)	VTW	280
Ash with Stain Finish	WOA/WBA	100
	WWA	115
	WGA/WNP	130
Power Module (2-power, 2-USB)	PM1	343

**Specifiable Finishes**

Linoleum Choose from Forbo linoleum products on page 7

Wood Choose from Memo Wood Finishes on page 7

**Notes**

For step-by-step specifications and quotes, access our live quote tool online at → Quotes

**Penna**

Small Round Table

Designed by Studio Gorm, 2019

Made in the USA.

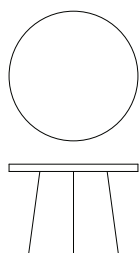

Depth	Width	Height
22.5"	22.5"	16"

Core Product	Core Code	List Price
Small Round Table - Ash	SG01-T3-A	2000
Small Round Table - Walnut	SG01-T3-W	2194

**Standard with Core Product**

- Glides
- Forbo Linoleum Top
- Solid Wood Edge Band (finish to match base)
- Wood Veneer Base

**Options**

Component	Code	List Price Add
Forbo Linoleum Top	FTT	0
Wood Veneer Top (Ash)	VTA	137
Wood Veneer Top (Walnut)	VTW	181
Ash with Stain Finish	WOA/WBA	80
	WWA	95
	WGA/WNP	110
Power Module (2-power, 2-USB)	PM1	343

**Specifiable Finishes**

- Linoleum Choose from Forbo linoleum products on page 7
- Wood Choose from Memo Wood Finishes on page 7

**Notes**

For step-by-step specifications and quotes, access our live quote tool online at → Quotes

**Penna**

Bar Table

Designed by Studio Gorm, 2020

Made in the USA.

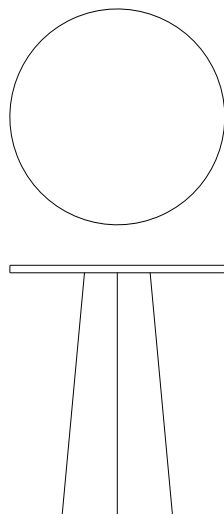

Depth	Width	Height
36"	36"	42"

Core Product	Core Code	List Price
Bar Table - Ash	SG01-T8-36D-A	3709
Bar Table - Walnut	SG01-T8-36D-W	3866

**Standard with Core Product**

- Glides
- Forbo Linoleum Top
- Solid Wood Edge Band (finish to match base)
- Wood Veneer Base

**Options**

Component	Code	List Price Add
Forbo Linoleum Top	FTT	0
Wood Veneer Top (Ash)	VTA	214
Wood Veneer Top (Walnut)	VTW	229
Ash with Stain Finish	WOA/WBA	110
	WWA	130
	WGA/WNP	150
Power Module (2-power, 2-USB)	PM1	343

**Specifiable Finishes**

- Linoleum Choose from Forbo linoleum products on page 7
- Wood Choose from Memo Wood Finishes on page 7

**Notes**

Bases ship with sandbags in certain models, for ballast

For step-by-step specifications and quotes, access our live quote tool online at → [Quotes](#)

**Penna**

Café Table

Designed by Studio Gorm, 2020

Made in the USA.

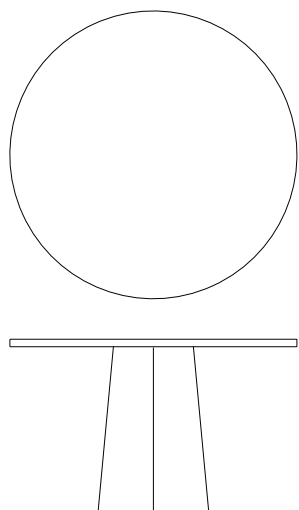

Depth	Width	Height
48"	48"	29"

Core Product	Core Code	List Price
Café Table - Ash	SG01-T6-48D-A	3802
Café Table - Walnut	SG01-T6-48D-W	4031

**Standard with Core Product**

- Glides
- Forbo Linoleum Top
- Solid Wood Edge Band (finish to match base)
- Wood Veneer Base

**Options**

Component	Code	List Price Add
Forbo Linoleum Top	FTT	0
Wood Veneer Top (Ash)	VTA	225
Wood Veneer Top (Walnut)	VTW	289
Ash with Stain Finish	WOA/WBA	100
	WWA	120
	WGA/WNP	140
Power Module (2-power, 2-USB)	PM1	343

**Specifiable Finishes**

- Linoleum Choose from Forbo linoleum products on page 7
- Wood Choose from Memo Wood Finishes on page 7

**Notes**

Bases ship with sandbags in certain models, for ballast

For step-by-step specifications and quotes, access our live quote tool online at → [Quotes](#)

**Penna**

Meeting Table

Designed by Studio Gorm, 2020

Made in the USA.

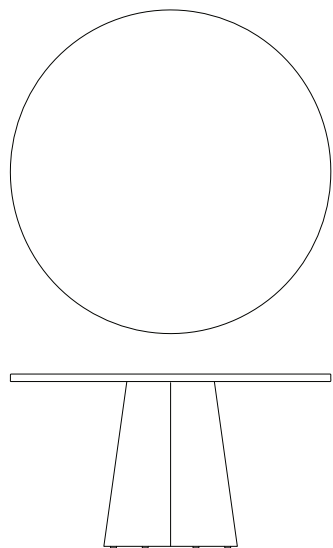

Depth	Width	Height
54"	54"	29"

Core Product	Core Code	List Price
Meeting Table - Ash	SG01-T7-54D-A	3831
Meeting Table - Walnut	SG01-T7-54D-W	4123

**Standard with Core Product**

- Glides
- Forbo Linoleum Top
- Solid Wood Edge Band (finish to match base)
- Wood Veneer Base

**Options**

Component	Code	List Price Add
Forbo Linoleum Top	FTT	0
Wood Veneer Top (Ash)	VTA	296
Wood Veneer Top (Walnut)	VTW	354
Ash with Stain Finish	WOA/WBA	100
	WWA	120
Power Module (2-power, 2-USB)	WGA/WNP	140
	PM1	343

**Specifiable Finishes**

- Linoleum Choose from Forbo linoleum products on page 7
- Wood Choose from Memo Wood Finishes on page 7

## Notes

Bases ship with sandbags in certain models, for ballast

For step-by-step specifications and quotes, access our live quote tool online at → [Quotes](#)



**Penna**

Height Adjustable Café Table  
Designed by Studio Gorm, 2020  
Made in the USA.

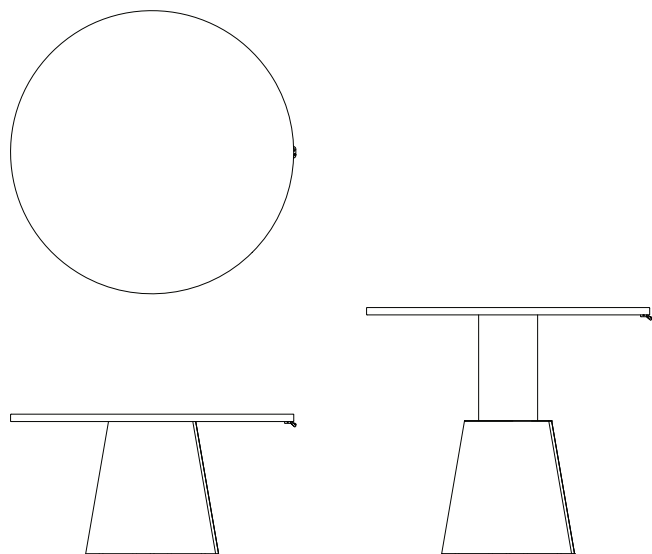

Depth	Width	Height
48"	48"	24" - 42"

Core Product	Core Code	List Price
Café Table - Ash	SG01-T6-HAT-48D-A-MA	7247
Café Table - Walnut	SG01-T6-HAT-48D-W-MA	7517

**Standard with Core Product**

- Glides
- Forbo Linoleum Top
- Solid Wood Edge Band (finish to match base)
- Wood Veneer Base

**Options**

Component	Code	List Price Add
Forbo Linoleum Top	FTT	0
Wood Veneer Top (Ash)	VTA	348
Wood Veneer Top (Walnut)	VTW	386
Ash with Stain Finish	WOA/WBA	160
	WWA	180
	WGA/WNP	200
Adjustable Height Column Shroud	PEW/PCY/PFG/POB/PBO/PSG/PDP	0

Specifiable Finishes and Notes overleaf

## Specifiable Finishes

Linoleum	Choose from Forbo linoleum products on page 7
Wood	Choose from Memo Wood Finishes on page 7
Painted Wood	PEW/PCY/PFG/POB/PBO/PSG/PDP

## Notes

Bases ship with sandbags in certain models, for ballast

For step-by-step specifications and quotes, access our live quote tool online at → [Quotes](#)

**Penna**

Height Adjustable Meeting Table

Designed by Studio Gorm, 2020

Made in the USA.

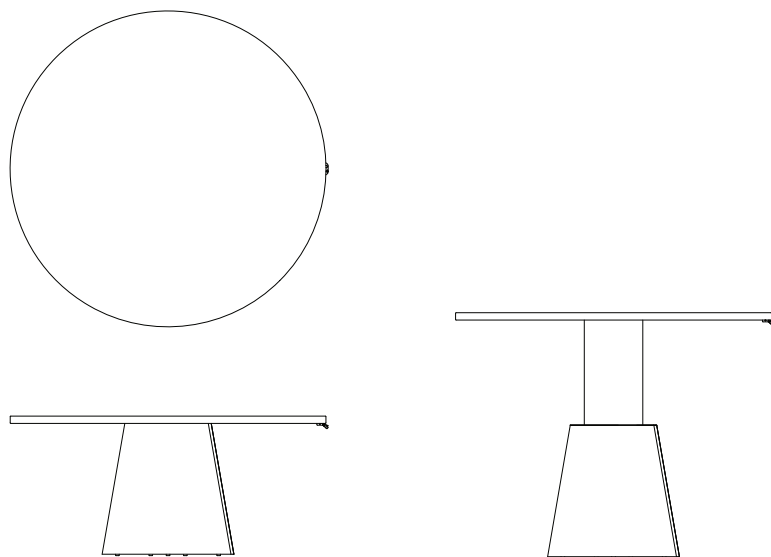

Depth	Width	Height
54"	54"	24" - 42"

**Core Product**

Meeting Table - Ash  
Meeting Table - Walnut

**Core Code**

SG01-T7-HAT-54D-A-MA  
SG01-T7-HAT-54D-W-MA

**List Price**

7329  
7678

**Standard with Core Product**

- Glides
- Forbo Linoleum Top
- Solid Wood Edge Band (finish to match base)
- Wood Veneer Base

**Options**

Component	Code	List Price Add
Forbo Linoleum Top	FTT	0
Wood Veneer Top (Ash)	VTA	437
Wood Veneer Top (Walnut)	VTW	451
Ash with Stain Finish	WOA/WBA	160
	WWA	180
	WGA/WNP	200
Adjustable Height Column Shroud	PEW/PCY/PFG/POB/PBO/PSG/PDP	0

Specifiable Finishes and Notes overleaf

## Specifiable Finishes

Linoleum	Choose from Forbo linoleum products on page 7
Wood	Choose from Memo Wood Finishes on page 7
Painted Wood	PEW/PCY/PFG/POB/PBO/PSG/PDP

## Notes

Bases ship with sandbags in certain models, for ballast

For step-by-step specifications and quotes, access our live quote tool online at → [Quotes](#)

**Penna**

Height Adjustable Café Table  
Designed by Studio Gorm, 2020  
Made in the USA.

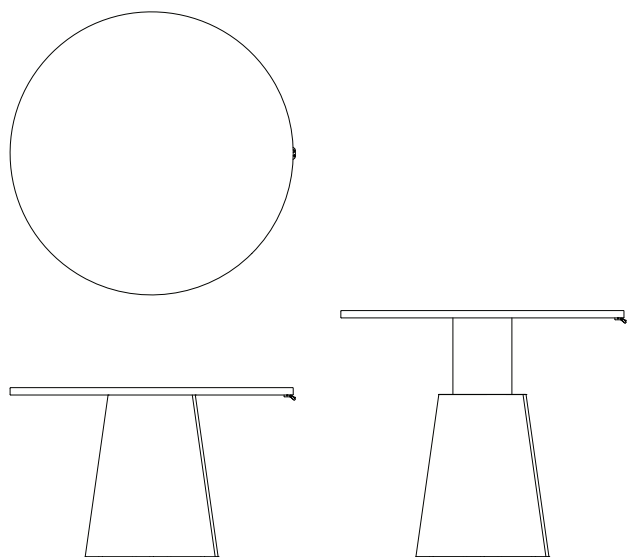

Depth	Width	Height
48"	48"	29" - 42"

Core Product	Core Code	List Price
Café Table - Ash	SG01-T6-HAT-48D-A-MB	7247
Café Table - Walnut	SG01-T6-HAT-48D-W-MB	7517

**Standard with Core Product**

- Glides
- Forbo Linoleum Top
- Solid Wood Edge Band (finish to match base)
- Wood Veneer Base

**Options**

Component	Code	List Price Add
Forbo Linoleum Top	FTT	0
Wood Veneer Top (Ash)	VTA	348
Wood Veneer Top (Walnut)	VTW	386
Ash with Stain Finish	WOA/WBA	160
	WWA	180
	WGA/WNP	200
Adjustable Height Column Shroud	PEW/PCY/PFG/POB/PBO/PSG/PDP	0

Specifiable Finishes and Notes overleaf

## Specifiable Finishes

Linoleum	Choose from Forbo linoleum products on page 7
Wood	Choose from Memo Wood Finishes on page 7
Painted Wood	PEW/PCY/PFG/POB/PBO/PSG/PDP

## Notes

Bases ship with sandbags in certain models, for ballast

For step-by-step specifications and quotes, access our live quote tool online at → [Quotes](#)

**Penna**

Height Adjustable Meeting Table

Designed by Studio Gorm, 2020

Made in the USA.

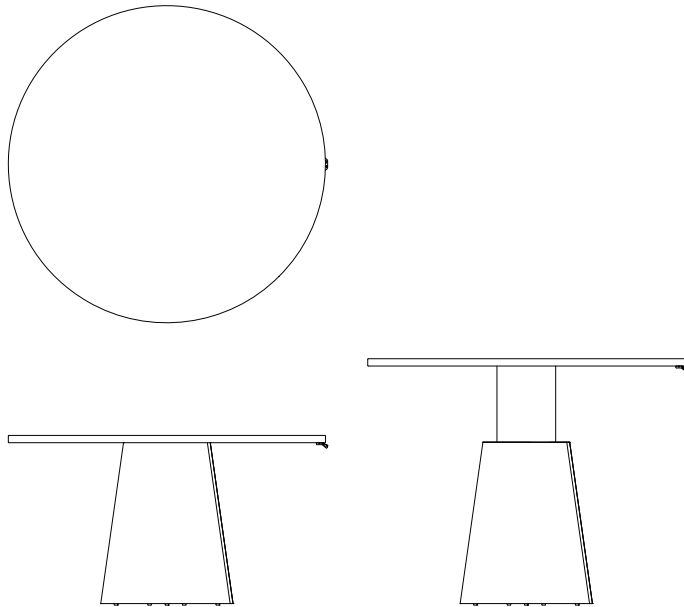

Depth	Width	Height
54"	54"	29" - 42"

Core Product	Core Code	List Price
Meeting Table - Ash	SG01-T7-HAT-54D-A-MB	7329
Meeting Table - Walnut	SG01-T7-HAT-54D-W-MB	7678

**Standard with Core Product**

- Glides
- Forbo Linoleum Top
- Solid Wood Edge Band (finish to match base)
- Wood Veneer Base

**Options**

Component	Code	List Price Add
Forbo Linoleum Top	FTT	0
Wood Veneer Top (Ash)	VTA	208
Wood Veneer Top (Walnut)	VTW	437
Ash with Stain Finish	WOA/WBA	160
	WWA	180
	WGA/WNP	200
Adjustable Height Column Shroud	PEW/PCY/PFG/POB/PBO/PSG/PDP	0

Specifiable Finishes and Notes overleaf

## Specifiable Finishes

Linoleum	Choose from Forbo linoleum products on page 7
Wood	Choose from Memo Wood Finishes on page 7
Painted Wood	PEW/PCY/PFG/POB/PBO/PSG/PDP

## Notes

Bases ship with sandbags in certain models, for ballast

For step-by-step specifications and quotes, access our live quote tool online at → [Quotes](#)



**Prose Seating**

Side Chair with Arms  
Designed by Memo Studio, 2017  
Made in the USA.

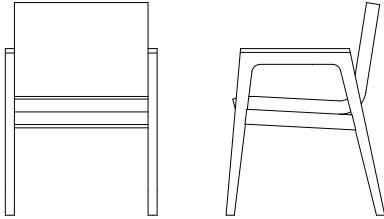

<b>Depth</b>	<b>Width</b>	<b>Height</b>
24"	23"	33"

**Core Product**

Side Chair with Arms - Ash

**Core Code**

GC01-10-A

**Textile Yardage**

Total: 1.50

<b>Seat</b>	<b>Back</b>	<b>Arms</b>
-------------	-------------	-------------

n/a	n/a	n/a
-----	-----	-----

**List Price by Textile Grade**

	COM / 1	2	3	4	5	6	7	8	9	10	11	12	13	14	15
GC01-10-A	1998	2015	2037	2052	2069	2090	2115	2142	2174	2216	2268	2321	2399	2510	2621

**Standard with Core Product**

- Glides
- High Resilience Polyurethane Foam
- Solid Wood Arm Caps

Options and Notes overleaf

**Options**

Component	Code	List Price Add						
Ash with Stain Finish	WOA/WBA	70						
	WWA	140						
	WGA/WNP	210						
Solid Surface Arm Caps	by Grade (right)	CA1	CA2	CA3	CA4	CA5	CA6	CA7
		277	337	337	474	474	553	553
Removable Covers	RC	249						
Moisture Barrier	MB	222						

**Specifiable Finishes**

- Solid Surface Choose from Corian solid surface products on page 82
- Textiles Choose from Camira, Kvadrat, or Maharam textiles on page 80, or contact Memo for assistance with COM fabrics
- Wood Choose from Memo Wood Finishes on page 7

**Notes**

Due to its continuous seat and back, multiple fabric configurations are not supported on the Prose Side Chair with Arms  
For step-by-step specifications and quotes, access our live quote tool online at [memofurniture.com/quotes](http://memofurniture.com/quotes)

**Prose Seating**

Plus Chair

Designed by Memo Studio, 2017

Made in the USA.

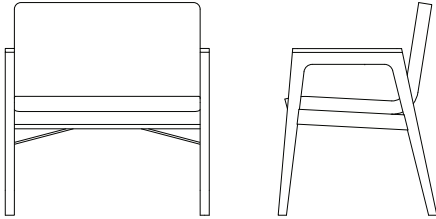

<b>Depth</b>	<b>Width</b>	<b>Height</b>
24"	30.75"	33"

**Core Product**

Plus Chair - Ash

**Core Code**

GC01-15-A

**Textile Yardage**

Total: 2.00

<b>Seat</b>	<b>Back</b>	<b>Arms</b>
n/a	n/a	n/a

**List Price by Textile Grade**

	COM / 1	2	3	4	5	6	7	8	9	10	11	12	13	14	15
GC01-15-A	2409	2431	2461	2481	2503	2531	2565	2601	2643	2699	2769	2839	2943	3091	3239

**Standard with Core Product**

Glides

High Resilience Polyurethane Foam

Solid Wood Arm Caps

Options and Notes overleaf

**Options**

Component	Code	List Price Add							
Ash with Stain Finish	WOA/WBA	70							
	WWA	140							
	WGA/WNP	210							
Solid Surface Arm Caps	by Grade (right)	CA1	CA2	CA3	CA4	CA5	CA6	CA7	
		277	337	337	474	474	553	553	
Removable Covers	RC	179							
Moisture Barrier	MB	222							

**Specifiable Finishes**

- Solid Surface Choose from Corian solid surface products on page 82
- Textiles Choose from Camira, Kvadrat, or Maharam textiles on page 80, or contact Memo for assistance with COM fabrics
- Wood Choose from Memo Wood Finishes on page 7

**Notes**

Due to its continuous seat and back, multiple fabric configurations are not supported on the Prose Plus Chair  
For step-by-step specifications and quotes, access our live quote tool online at [memofurniture.com/quotes](https://memofurniture.com/quotes)

**Prose Seating**

Settee

Designed by Memo Studio, 2017

Made in the USA.

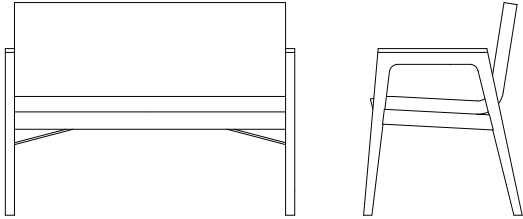

Depth	Width	Height
24"	43.75"	33"

**Core Product**

Settee - Ash

**Core Code**

GC01-22-A

**Textile Yardage**

Total: 2.50

Seat	Back	Arms
n/a	n/a	n/a

**List Price by Textile Grade**

	COM / 1	2	3	4	5	6	7	8	9	10	11	12	13	14	15
GC01-22-A	3156	3184	3221	3246	3274	3309	3351	3396	3449	3519	3606	3694	3824	4009	4194

**Standard with Core Product**

Glides

High Resilience Polyurethane Foam

Solid Wood Arm Caps

Options and Notes overleaf

**Options**

Component	Code	List Price Add							
Ash with Stain Finish	WOA/WBA	88							
	WWA	158							
	WGA/WNP	245							
Solid Surface Arm Caps	by Grade (right)	CA1	CA2	CA3	CA4	CA5	CA6	CA7	
		277	337	337	474	474	553	553	
Removable Covers	RC	297							
Moisture Barrier	MB	244							

**Specifiable Finishes**

- Solid Surface Choose from Corian solid surface products on page 82
- Textiles Choose from Camira, Kvadrat, or Maharam textiles on page 80, or contact Memo for assistance with COM fabrics
- Wood Choose from Memo Wood Finishes on page 7

**Notes**

Due to its continuous seat and back, multiple fabric configurations are not supported on the Prose Settee  
For step-by-step specifications and quotes, access our live quote tool online at [memofurniture.com/quotes](https://memofurniture.com/quotes)

**Prose Seating**

Lounge

Designed by Memo Studio, 2017

Made in the USA.

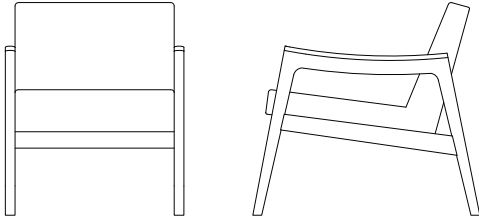

<b>Depth</b>	<b>Width</b>	<b>Height</b>
32"	25.5"	30"

**Core Product**

Lounge - Ash

**Core Code**

GC01-01-A

**Textile Yardage**

Total: 2.00

<b>Seat</b>	<b>Back</b>	<b>Arms</b>
1.00	1.00	n/a

**List Price by Textile Grade**

	COM / 1	2	3	4	5	6	7	8	9	10	11	12	13	14	15
GC01-01-A	2772	2794	2824	2844	2866	2894	2928	2964	3006	3062	3132	3202	3306	3454	3602

**Standard with Core Product**

Glides

High Resilience Polyurethane Foam

Solid Wood Arm Caps

Options and Notes overleaf

**Options**

Component	Code	List Price Add						
Ash with Stained Finish	WOA/WBA	70						
	WWA	140						
	WGA/WNP	210						
Solid Surface Arm Caps	by Grade (right)	CA1	CA2	CA3	CA4	CA5	CA6	CA7
		291	354	354	499	499	582	582
Removable Covers	RC	279						
Moisture Barrier	MB	222						
Multiple Textiles (Seat/Back)	TA	140						

**Specifiable Finishes**

- Solid Surface Choose from Corian solid surface products on page 82
- Textiles Choose from Camira, Kvadrat, or Maharam textiles on page 80, or contact Memo for assistance with COM fabrics
- Wood Choose from Memo Wood Finishes on page 7

**Notes**

Available in custom widths per engineering and quote approval  
 Multiple fabric option allows for separate seat and back textiles  
 For step-by-step specifications and quotes, access our live quote tool online at [memofurniture.com/quotes](https://memofurniture.com/quotes)



**Prose Seating**

Loveseat

Designed by Memo Studio, 2017

Made in the USA.

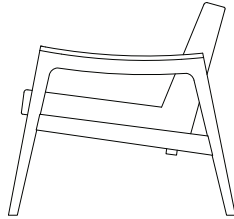
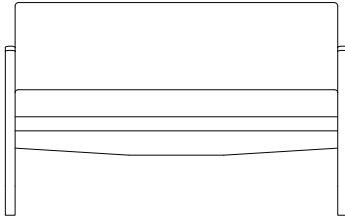

Depth	Width	Height
32"	48"	30"

**Core Product**

Loveseat - Ash

**Core Code**

GC01-02-A

Textile Yardage	Seat	Back	Arms
Total: 4.00	2.00	2.00	n/a

**List Price by Textile Grade**

	COM / 1	2	3	4	5	6	7	8	9	10	11	12	13	14	15
GC01-02-A	3527	3571	3631	3671	3715	3771	3839	3911	3995	4107	4247	4387	4595	4891	5187

**Standard with Core Product**

Glides

High Resilience Polyurethane Foam

Solid Wood Arm Caps

Options and Notes overleaf

**Options**

Component	Code	List Price	Add												
Ash with Stain Finish	WOA/WBA	88													
	WWA	158													
	WGA/WNP	245													
Solid Surface Arm Caps	by Grade (right)	CA1	291	CA2	354	CA3	354	CA4	499	CA5	499	CA6	582	CA7	582
Removable Covers	RC	319													
Moisture Barrier	MB	252													
Multiple Textiles (Seat/Back)	TA	140													

**Specifiable Finishes**

- Solid Surface Choose from Corian solid surface products on page 82
- Textiles Choose from Camira, Kvadrat, or Maharam textiles on page 80, or contact Memo for assistance with COM fabrics
- Wood Choose from Memo Wood Finishes on page 7

**Notes**

Available in custom widths per engineering and quote approval  
 Multiple fabric option allows for separate seat and back textiles  
 For step-by-step specifications and quotes, access our live quote tool online at [memofurniture.com/quotes](http://memofurniture.com/quotes)

**Rolo**

Lounge

Designed by Studio Tolvanen, 2021

Made in the USA.

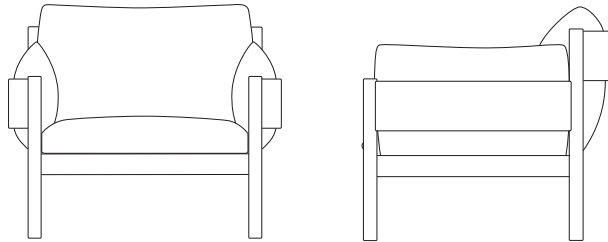

Depth      Width      Height  
32"          36"          31"

**Core Product**

Lounge - Ash  
Lounge - Walnut

**Core Code**

ST01-01-A  
ST01-01-W

**Textile Yardage**

Total: 5.25

**List Price by Textile Grade\***

	COM / 1	2	3	4	5	6	7	8	9	10	11	12	13	14	15
ST01-01-A	4097	4155	4234	4286	4344	4417	4507	4601	4711	4858	5032	5226	5499	5887	6276
ST01-01-W	5234	5292	5371	5423	5481	5554	5644	5738	5848	5995	6169	6363	6636	7024	7413

\*Pricing assumes non-railroaded textiles. For railroaded pricing please contact us at [info@memofurniture.com](mailto:info@memofurniture.com)

**Standard with Core Product**

Non-Marring Glides  
High Resilience Polyurethane Foam

**Options**

	Code	List Price Add
Clear Finish (by species)	WCA/WCW	0
Ash with Stain Finish	WOA/WBA	83
	WWA	132
	WGA/WNP	198

**Specifiable Finishes**

Textiles      Choose from Camira, Maharam, or Kvadrat textiles on page 80, or contact Memo for assistance with COM fabrics  
Wood          Choose from Memo Wood Finishes on page 7

**Notes**

For step-by-step specifications and quotes, access our live quote tool online at → [Quotes](#)

**Rolo**

Loveseat

Designed by Studio Tolvanen, 2021

Made in the USA.

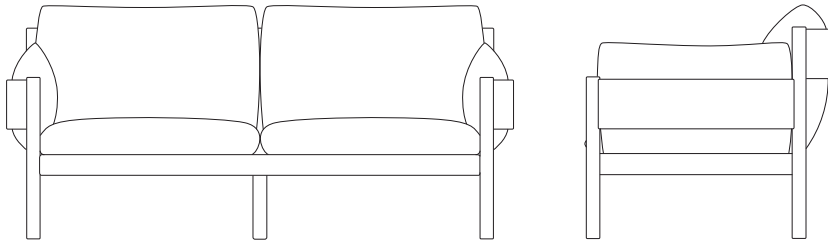

<b>Depth</b>	<b>Width</b>	<b>Height</b>
32"	65"	31"

**Core Product**

Loveseat - Ash  
Loveseat - Walnut

**Core Code**

ST01-02-A  
ST01-02-W

**Textile Yardage**

Total: 8.25

**List Price by Textile Grade\***

	COM / 1	2	3	4	5	6	7	8	9	10	11	12	13	14	15
ST01-02-A	6141	6232	6356	6438	6529	6644	6785	6933	7106	7337	7610	7915	8344	8954	9565
ST01-02-W	8032	8123	8247	8329	8420	8535	8676	8824	8997	9228	9501	9806	10235	10845	11456

\*Pricing assumes non-railroaded textiles. For railroaded pricing please contact us at [info@memofurniture.com](mailto:info@memofurniture.com)

**Standard with Core Product**

Non-Marring Glides  
High Resilience Polyurethane Foam

**Options**

	<b>Code</b>	<b>List Price Add</b>
Clear Finish (by species)	WCA/WCW	0
Ash with Stain Finish	WOA/WBA	96
	WWA	152
	WGA/WNP	231

**Specifiable Finishes**

Textiles Choose from Camira, Maharam, or Kvadrat textiles on page 80, or contact Memo for assistance with COM fabrics  
Wood Choose from Memo Wood Finishes on page 7

**Notes**

For step-by-step specifications and quotes, access our live quote tool online at → [Quotes](#)

**Rolo**

Sofa

Designed by Studio Tolvanen, 2021

Made in the USA.

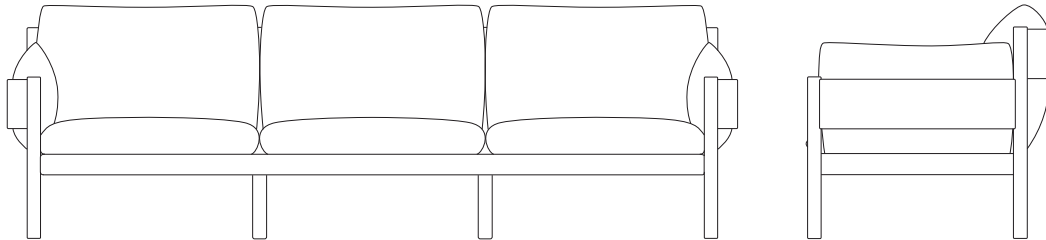

Depth	Width	Height
32"	94"	31"

**Core Product**

Sofa - Ash  
Sofa - Walnut

**Core Code**

ST01-03-A  
ST01-03-W

**Textile Yardage**

Total: 11.5

**List Price by Textile Grade\***

	COM / 1	2	3	4	5	6	7	8	9	10	11	12	13	14	15
ST01-03-A	8421	8548	8720	8835	8962	9123	9318	9525	9767	10089	10468	10894	11492	12343	13194
ST01-03-W	10640	10767	10939	11054	11181	11342	11537	11744	11986	12308	12687	13113	13711	14562	15413

\*Pricing assumes non-railroaded textiles. For railroaded pricing please contact us at [info@memofurniture.com](mailto:info@memofurniture.com)

**Standard with Core Product**

Non-Marring Glides  
High Resilience Polyurethane Foam

**Options**

	Code	List Price Add
Clear Finish (by species)	WCA/WCW	0
Ash with Stain Finish	WOA/WGA	116
	WWA	175
	WGA/WNP	264

**Specifiable Finishes**

Textiles Choose from Camira, Maharam, or Kvadrat textiles on page 80, or contact Memo for assistance with COM fabrics  
Wood Choose from Memo Wood Finishes on page 7

**Notes**

For step-by-step specifications and quotes, access our live quote tool online at → [Quotes](#)

**Rolo**

Side Table

Designed by Studio Tolvanen, 2021

Made in the USA.

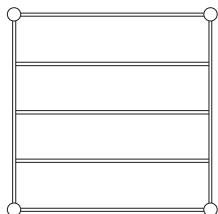

Depth	Width	Height
27.75"	27.75"	11"

Core Product	Core Code	List Price
Side Table - Ash	ST01-T1-A	1249
Side Table - Walnut	ST01-T1-W	1672

**Standard with Core Product**

Glides

**Options**

**Specifiable Finishes**

Choose from Memo Wood Finishes on page 7

	Code	List Price Add
Clear Finish (by species)	WCA/WCW	0
Ash with Stain Finish	WOA/WBA	93
	WWA	147
	WGA/WNP	222

**Notes**

For step-by-step specifications and quotes, access our live quote tool online at → [Quotes](#)

**Rolo**

Coffee Table

Designed by Studio Tolvanen, 2021

Made in the USA.

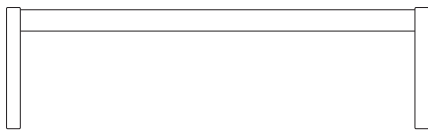
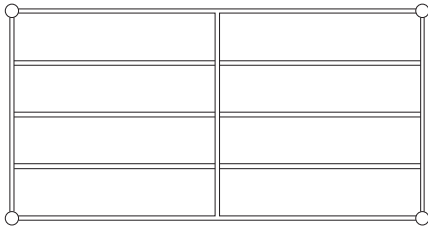

Depth	Width	Height
27.75"	53.75"	15"

Core Product	Core Code	List Price
Coffee Table - Ash	ST01-T2-A	1806
Coffee Table - Walnut	ST01-T2-W	2423

**Standard with Core Product**

Glides

**Options**

**Specifiable Finishes**

Choose from Memo Wood Finishes on page 7

	Code	List Price Add
Clear Finish (by species)	WCA/WCW	0
Ash with Stain Finish	WOA/WBA	112
	WWA	170
	WGA/WNP	256

**Notes**

For step-by-step specifications and quotes, access our live quote tool online at → [Quotes](#)

Textiles Graded-in sorted by pattern name **Camira**

Pattern Name	Group
Blazer	7
Carragan Flax	10
Era	2
Gravity	2
Main Line Flax	7
Oceanic	6
Quest	3
Rivet	2
Synergy	7

Textiles Graded-in sorted by pattern name **Maharam**

Article	458600	6
Beck	466570	10
Bluff	466489	9
Brindle	466418	8
Campana	466571	12
Chasm	466404	10
Darning Sampler Plaid	466462	15
Felix	466625	12
Firma	466582	11
Flock	901892	8
Frequency	466504	10
Gemma	466568	11
Gemma Multi	466569	11
Isa	466624	12
Jasper	466563	10
Lariat	440401	4
Ledger	463770	9
Manner	466177	5
Mantle	466517	8
Meld	466387	5
Merit	458600	6
Messenger	458640	5
Metaphor	466553	5
Metric	466014	5
Method	466579	5
Mode	466337	6
Murmur	466446	5
Muse	466487	4
Nico	466564	8
Pare	466359	11

Textiles Graded-in sorted by pattern name **Kvadrat**

Pattern Name	Group
Arda (Febrik)	13
Canvas 2	10
Coda 2	14
Divina MD	11
Divina Melange 3	11
Fiord 2	12
Hallingdal 65	12
Harald 3	13
Melange Nap	11
Remix 3	9
Re-Wool	10
Steelcut 2	11
Steelcut Trio 3	11
Tonica 2	10



Textiles Graded-in sorted by Grading Group: **Camira**

Group & Price/yard	Pattern Name
Group 1 48	
Group 2 59	Era
	Gravity
	Rivet
Group 3 74	Quest
Group 4 84	
Group 5 95	
Group 6 109	Oceanic
Group 7 126	Blazer
	Main Line Flax
	Synergy
Group 8 144	
Group 9 165	
Group 10 193	Craggan Flax

Textiles Graded-in sorted by Grading Group: **Kvadrat**

Group & Price/yard	Pattern Name
Group 1 48	
Group 2 59	
Group 3 74	
Group 4 84	
Group 5 95	
Group 6 109	
Group 7 126	
Group 8 144	
Group 9 165	Remix 3
Group 10 193	Canvas 2
	Re-wool
	Tonica 2
Group 11 228	Divina MD
	Divina Melange 3
	Melange Nap
	Steelcut 2
	Steelcut Trio 3
Group 12 263	Fiord 2
	Hallingdal 65
Group 13 315	Arda (Febrik)
	Harald 3
Group 14 389	Coda 2

Textiles Graded-in sorted by Grading Group: **Maharam**

Group & Price/yard	Pattern Name	Number
Group 1 48		
Group 2 59		
Group 3 74		
Group 4 84	Lariat	440401
	Muse	466487
Group 5 95	Manner	466177
	Meld	466387
	Messenger	458640
	Metaphor	466553
	Method	466579
	Metric	466014
	Murmur	466446
Group 6 109	Article	458600
	Merit	458600
	Mode	466337
Group 7 126		
Group 8 144	Brindle	466418
	Flock	901892
	Mantle	466517
	Nico	466564
Group 9 165	Bluff	466489
	Ledger	463770
Group 10 193	Beck	466570
	Chasm	466404
	Frequency	466504
	Jasper	466563
Group 11 228	Firma	466582
	Gemma	466568
	Gemma Multi	466569
	Pare	466359
Group 12 263	Campana	466571
	Felix	466625
	Isa	466624
Group 13		
Group 14 389	Darning Sampler Plaid	466462

Corian Solid Surface Schedule sorted by Grading Group

<b>Group 1</b>	Abalone Bisque Bone Cameo White Glacier White Linen Maui Sahara Sandstone Silver Gray Vanilla	<b>Group 4</b>	Deep Caviar Deep Mink Deep Night Sky Dove Flint Fossil Granola Pine Raffia Rice Paper Royal Red Seafoam Serene Sage Suede Venaro White Whisper White Jasmine	<b>Group 5</b>	Whipped Cream Willow	<b>Group 7</b>	Minera Nimbus Prima Sagebrush Sand Storm Smoke Drift Prima Sonora Stardust White Onyx Windswept Prima
<b>Group 2</b>	Antarctica Aurora Blue Pebble Canyon Cocoa Brown Designer White Modern White Mojave Sand Savannah Stratus Summit White	<b>Group 5</b>	Anthracite Ash Concrete Blue Spice Carbon Concrete Cilantro Deep Anthracite Deep Bedrock Deep Cloud Deep Espresso Deep Nocturne Deep Sable Deep Space Deep Storm Deep Titanium Doeskin Fawn Glacier Ice Matterhorn Neutral Concrete Oat Silver Birch Silverite Weathered Concrete	<b>Group 6</b>	Arrowroot Basil Clam Shell Cool Gray Cosmos Prima Earth Gray Onyx Hazelnut Jasmine Keystone Lava Rock Limev Prima Natural Gray Rain Cloud Riverbed Rosemary Saffron Sandalwood Sorrel Tumbleweed Witch Hazel		
<b>Group 3</b>	Elegant Gray Everest Moss Nightfall Pearl Gray Platinum Silt Sparkling White			<b>Group 7</b>	Allspice Aqualite Burlled Beach Cocoa Prima Deep Inkwell Deep Lapis Deep Smoky Pear Deep Terrain Dune Prima Ecru Elderberry Evening Prima Graylite Hickory Smoke Juniper Milky Way		
<b>Group 4</b>	Arctic Ice Bronzite Canvas Cobalt Concrete Cottage Lane Deep Black Quartz						