

memo

Pricelist
2024 / Q2

memo

Contents

page 3 Terms of Sale
page 4 Limited Lifetime Warranty
page 5 Customer Service
page 6 Finishes Overview
page 8 Textiles Overview

page 12 April Seating

page 12 Side Chair
page 13 ADA Stool
page 14 Counter Stool
page 15 Bar Stool
page 16 Bar Stool w/ Low Back

page 17 B-Side Tables

page 17 Personal Table
page 19 Side Table
page 21 Coffee Table

page 23 Chord Tables

page 23 Personal Table
page 25 Side Table
page 27 Coffee Table

page 29 Chroma Seating

page 29 Lounge
page 30 Lounge Armless
page 31 Lounge Swivel
page 32 Ottoman - 17
page 33 Ottoman - 24
page 34 Ottoman - 29
page 35 Ottoman - 38

page 36 Ida

page 36 Ida

page 37 Kino

page 37 Kino

page 39 Maru Benches

page 39 Three Slat Bench, 3/4 Length
page 41 Three Slat Bench
page 43 Five Slat Bench
page 46 Seven Slat Bench

page 49 Orca Screens

page 49 Vertical Screen
page 51 Horizontal Screen

page 53 Penna Seating

page 53 Penna Lounge

page 54 Penna Tables

page 54 Large Round
page 55 Obround
page 56 Small Round
page 57 Bar Table
page 59 Café Table
page 61 Meeting Table
page 63 Height Adjustable Cafe table 24-42, 48 diameter
page 65 Height Adjustable Meeting table 24-42, 54 diameter
page 67 Height Adjustable Cafe table 29-42, 48 diameter
page 70 Height Adjustable Meeting table 24-42, 54 diameter

page 71 Prose Seating

page 71 Side Chair with Arms
page 73 Plus Chair
page 75 Settee
page 77 Lounge
page 80 Loveseat

page 81 Rolo Seating

page 81 Lounge
page 83 Loveseat
page 84 Sofa

page 84 Rolo Tables

page 84 Side Table
page 85 Coffee Table

page 86 Materials & Finishes Schedules

page 86 Textiles Schedule
page 88 Corian Solid Surface Schedule

Terms of Sale

Pricing Policy

All prices shown for products and accessories are manufacturer's suggested list price. Prices shown do not include freight, surcharges, appropriate taxes, crating (if applicable), storage, or installation charges. Memo reserves the right to amend price lists, change designs, and discontinue or add models without prior notice. Price list of latest date supersedes and cancels all previous lists. All orders accepted are subject to prices upon receipt of order.

Payment Terms

Except as otherwise specified, all orders require a 50% deposit with the balance due with thirty (30) days from the invoice date. All payments are payable in U.S. dollars. Lead times start after the receipt of deposit. Payments not made by the due date may incur, at the sole discretion of Memo, a late payment service charge of 1.5% per month. All payments and deposits are non-refundable.

Changes and Cancellations

Customers will receive a written confirmation of pricing, credit terms and estimated completion date. Changes to orders or cancellations made after production has begun will carry extra charges based on expenses incurred.

Shipping

Standard cartoning and standard surface freight to any point within the 48 contiguous United States is included in Memo quotes as a separate charge independent of product price. For shipments to Alaska, Hawaii and International destinations, additional shipping and handling charges will apply. Orders are shipped cartoned as standard. If crating is requested or required, additional charges will apply and a custom quote will be provided. Service add-ons for freight will also include additional charges as follows:

Gate Lift : \$125 NET

Residential Delivery : \$150 NET

Delivery Appointment in Advance: \$100 NET

Any additional freight charges will be provided at the time of quote. From time to time, market conditions for fuel and/or labor may result in freight surcharges, beyond our standard rates. In these cases, surcharges will be indicated on all quotes.

Freight Claims

Product is shipped FOB Factory, freight prepaid and allowed via truck. The title of goods changes to the purchaser when merchandise leaves Memo's dock. All shipments are transferred to the transportation company in good condition.

Receiver and/or specifier are required to inspect cartons and product upon receipt and note the condition and any damage or shortage on the Bill of Lading upon delivery. Receiver and or specifier are required to notify Memo and the carrier of evident damage or product shortages at time of delivery and request an inspection. Failure to report evident damage or product shortages within (3) business days of delivery will be considered total and full acceptance of goods as is. In the case of shipping damage, the receiver and/or specifier is to provide Memo with photographs of the damaged carton/packaging and goods. Photographs are required for Memo to process and award if approved, any claims for recovery. Shipping cartons and packaging should be retained for carrier inspection and the damaged product should be kept in the receiving location. If the freight carrier will not perform the inspection, receiver and/or specifier should prepare an affidavit; noting that the freight company refused to comply with an inspection - citing date and time.

Any concealed damage claims against Memo for apparent damages must be made by the purchaser and or specifier in writing within five (5) business days of delivery, including a copy of the BOL and photographs of the carton/ packaging and damaged goods. Failure to notify Memo within 5 business days of receipt shall constitute acceptance of the product and waiver of any apparent damages resulting in replacement and or repair of damaged goods being billed to the purchaser.

Any relevant damage or shortages to blanket wrapped shipments must be noted on the Bill of Lading at the time of delivery.

Custom Requests

Requests to modify existing products (Modifications) or to produce ground-up solutions (Specials) should be submitted to our customer service group, at which time they will be assessed and submitted for design and engineering approval. All custom requests will elicit a receipt and a response will be provided within 48 hours of receipt. Upon approval, a price and lead-time quote will be generated and provided for customer review and acceptance.

10 Year Warranty

Memo Furniture warrants its products, to the original user and for the original purpose, to be free of defects in design, material and workmanship, given normal use and care for a period of ten (10) years, from date of delivery. This warranty does not include damage from accident, alteration, misuse, normal wear and tear, transportation or improper installation and maintenance.

During the warranty period, Memo Furniture, at its option, will repair or replace any product which, upon inspection by Memo Furniture or its designated representative, is deemed to be defective in materials or workmanship and is covered by this warranty.

This warranty does not apply to defects, wear, or failures, in components not manufactured by Memo Furniture, including but not limited to textiles, leathers, casters, and electronic components. In these cases, the warranty period provided by the supplier of the component will apply. The liability of Memo Furniture is limited to furnishing new parts as may be necessary to replace any item that may prove to be defective in material or workmanship. Memo Furniture will make every effort to replace parts if they are available from the supplier of those parts. We will not assume liability for charges for labor, consequential expenses or damages incurred.

Approvals by Memo to use COM or COL textiles refer to our ability to apply and execute said material on our products only and do not include durability, cleanability, suitability, and wear. Appropriate specification of any textile or leather is the sole responsibility of the specifier.

Normal aging and wear of any COM, COL, or Graded In, woven and non-woven upholstery are exempt from this warranty. Please check with the textile manufacturer for their warranty and appropriate cleaning instructions.

Due to natural variations, in which Memo Furniture has no control, this warranty does not extend to color, grain, texture or the durability or suitability of any exterior surface coatings or treatments.

In addition to our standard furniture offering, Memo Furniture also manufactures Custom Product Solutions for specific needs. Custom Product Solutions are warranted for a period of one (1) year against defects in materials and workmanship.

This warranty is void in cases of damage in transit, negligence, abuse, abnormal usage, misuse, accidents, and improper cleaning and maintenance.

All other warranties, expressed or implied, are excluded. Memo Furniture shall not be liable for incidental or consequential damages of any sort.

Memo is committed to the complete satisfaction of our customers with our products and performance. If a problem arises with a Memo product after the expiration of the warranty period, Memo will exercise its best efforts to achieve your satisfaction in a manner that is fair to all concerned.

If you have any questions or wish to file a claim against this warranty, please contact us at: service@memofurniture.com

Customer Service

Memo's Customer Service Group is trained to assist with quotes, orders, custom requests, product details, warranty inquires, and to answer general questions.

We can be reached Monday through Friday, 7:00 am – 5:00 pm Pacific Time, directly via email at service@memofurniture.com or via our voicemail line at +1 206 995 8780.

Inquiries received after-hours via voicemail or email will receive a response before the close of business on the following business day.

Please visit www.memofurniture.com for answers to most questions including product prices, specifications, photos, SketchUp and Revit files, and marketing material.

Please visit our quote tool <https://staging-quotes.memofurniture.com> for 24/7 live access to quotes and our configurator. Additionally, a local sales representative can assist you further. Contact names and numbers are also available on our website.

Finishes

Memo offers a range of proprietary colors and finishes on select materials, as well as support for a broad range of open line laminates and solid surface. Our finishes have been curated to offer a foundation of essential base neutrals, to which accents and stronger colors can be added.

Memo offers finish and pattern selections in the following materials:

Forbo Furniture Linoleum

Memo offers Forbo furniture-grade linoleum on select products. Forbo is a durable surface material, available in a dynamic range of colors. Derived from solidified Linseed Oil and other natural fillers such as cork and wood dust, Forbo is a sustainable and resilient surface choice.

Metal Powder Coat

Our powder coats are applied to both steel and aluminum, and are available in textured and smooth finishes. Powder coating is extremely durable and emits zero pollutants once cured.

Natural Stone

Memo offers natural stone on select table and horizontal surface tops. Our stone is hand selected from the highest quality slabs however natural variances will occur from product to product.

Solid Surface

Memo offers Corian and Wilsonart solid surface options on certain products. Solid Surface, is a non-porous high durability product that is stain resistant, easy to clean, and easily repairable.

Wood & Veneer

Our products utilize both solid wood and wood veneer, and are offered in either Ash, Beech or Walnut depending on the product. Products with edge profiles will include a matching wood edge. Wood products are finished in a resilient, long lasting, conversion varnish.

Memo Colors and Finishes

Metal Powder Coat

Steel Gray Gloss	MSG
Med Bronze Gloss	MMB
Black Texture	MBT
Silver Metallic Gloss	MSM
Yellow Leaf Gloss	MYL
Copper Red Matte	MCR
Sage Green Matte	MGG
Navy Blue Matte	MNB

Natural Stone

White Gray Marble	RWM
-------------------	-----

Solid Surface (Wilsonart)

Black Onyx Mirage	STS-BLS
Hidden Spaces	STS-HIS
Kimberlite	STS-KIS
Yukon Riverstone	STS-YUS

Wood & Veneer

Clear over Ash	WCA
Oak Over Ash	WOA
Gray Over Ash	WGA
Walnut Over Ash	WWA
Black Over Ash	WBA
Clear Over Beech	WCB
Oak Over Beech	WOB
Gray Over Beech	WGB
Walnut Over Beech	WWB
Black Over Beech	WBB
Clear Over Walnut	WCW
Navy Painted Wood	WNP

Painted Wood

Blood Orange	PBO
Cashew Yellow	PCY
Cream White	PCW
Dusty Pink	PDP
Forest Green	PFG
Ocean Blue	POB
Stone Gray	PSG

Memo Supported Open-Line Finishes

Corian

Memo offers open line Corian solid surface options on the Prose Collection. For a list of Corian products by grade see page 82.

Forbo Furniture Linoleum

Ash - 4132	FAS
Burgundy - 4154	FBU
Iron - 4178	FIR
Pebble - 4175	FPE
Pewter - 4155	FPW
Powder - 4185	FPO
Smokey Blue - 4179	FSB

Cork

Natural	CNC
Dark Chocolate	CDK

Lamiate

xxx
xxx
xxx
xxx

Really

Cotton White	RCW
Blue Denim	RBD

Textiles

Graded-in Textiles

Memo has partnered with Camira, Kvadrat, and Maharam to offer graded-in textiles. All graded-in textiles are listed by Pattern Name on page 77 and by Grading Group on page 78. Our Grading Groups and their LIST prices per yard are outlined below. Published product prices, including the cost of Graded-in Textiles, have been calculated by multiplying by the price per yard figures below by the yardage requirements indicated on a given product page.

Grading Group	LIST Price per Yard
1	48
2	59
3	74
4	84
5	95
6	109
7	126
8	144
9	165
10	193
11	228
12	263
13	315
14	389
15	463

Memo is glad to grade in textiles from suppliers other than Camira, Kvadrat, and Maharam per customer requests. A grading fee of \$200 NET per pattern, per product, will apply in such cases. Please contact us to submit grading requests.

When specifying graded-in textiles the projected completion date of your order may exceed our normal lead times due to constraints of the textile supplier. In such instances, Memo will promptly communicate such delays and advise on adjusted lead times.

Textiles are subject to the quality and shipping standards of the provider. Memo assumes no responsibility for defects, color inaccuracies, shortages, wear, or performance of textiles.

Ordering a Textile Sample

Samples can be ordered by visiting the textile provider's website.

Textiles

Customer's Own Material (COM)

While we recommend selecting from our graded-in Camira, Kvadrat, and Maharam textile offer for the most streamlined process, we also provide the option to use COM. Memo, however, reserves the right to reject textiles which are unsuitable for upholstery on our products. This may be due to inadequate textile weight or unique elastic qualities which impact the integrity of upholstery on our products.

To select fabric outside of the graded-in fabric program, a few steps are required. Memo provides the total yardage for each product on its product spec sheets and pricelist reference pages. These published yardage figures are based on the application conditions of the cutting pattern for each product as well as managing quality issues. Certain textiles, depending on their width and/or repeat, may require additional yardage beyond the figures in our pricing pages. To calculate additional yardage, see our guidelines on page 11. Memo will also provide yardage requirements upon receipt of an order.

Upon receipt of the textile, Memo will immediately advise if flaws or deficiencies in the order are discovered. Memo assumes no responsibility for defects, color inaccuracies, shortages, wear, or sub-standard performance of the specified textiles.

Note that Memo will dispose of excess upholstery material at the time of shipment unless expressly requested to return it with the product shipment.

Customer's Own Leather (COL)

Please contact our customer service group at info@memofurniture.com or +1 206 995 8780.

Textiles**Delivery of Customer's Own Material (COM)**

Customers are responsible for ensuring delivery of COM fabric to Memo. Orders for COM-upholstered products will be scheduled into production upon receipt of all COM and swatches. Please work with our customer service group to procure written confirmation of textile supplier ship dates to ensure the best possible lead time. Since shipment of COM orders depends upon textile availability, lead times may vary.

When supplying COM textiles to Memo, please include the following info:

Textile supplier

Pattern name and number

Color name and number

A representative fabric swatch for identification purposes with face side marked

Any nonstandard treatments applied to the fabric

Any additional documentation

All COM or COL must be sent prepaid to the following address and tagged as follows:

Kaas Tailored c/o Memo Furniture

13000 Beverly Park Road, Suite A

Mukilteo, WA 98275

Attn: Receiving Department

Dealer name

P.O. #

Order code # (for each fabric)

Textiles

Order Requirements for Customer's Own Material (COM)

Memo reserves the right to reject textiles or materials. Textiles requiring secondary backing or coatings should be treated prior to shipping to Memo. All yardage figures listed in Memo product spec sheets and pricelist reference pages are based on at least 54" Wide, Plain Fabric.

Increases for Textile Width and/or Repeat

In the event that COM textile is both less than 54" wide and also has a repeat, add both of the two increases shown below. For textiles that require matching (stripes, plaids, prints, pattern repeats) it is Memo's policy to match all pattern repeats, stripes, prints or plaids unless specified 'No Matching Required' on purchase order.

Fabric Bolts Less than 54" Wide

Less than 54" wide	Add 08%
Less than 50" wide	Add 13%
Less than 48" wide	Add 20%
Less than 45" wide	Add 50%
Less than 36" wide	Add 60%

Fabrics with Repeats

Repeat 7" & less	Add 11%
Repeat 13" & less	Add 18%
Repeat 21" & less	Add 21%
Repeat 27" & less	Add 24%
Repeat more than 27"	Add 25%

Order Requirements for Customer's Own Leather (COL)

COL orders are based on an average hide size of 45 square feet of usable leather and 19 feet per yard. Due to shape and quality issues with some leather, additional hides may be required after receipt of COL. Ship full hides only.

To convert COM yardage requirements to COL square footage and number of hides, multiply the COM yardage by 19.

Example: 5 yards x 19 = 95 square feet.

April

Side Chair

Designed by Jun Yasumoto, 2022

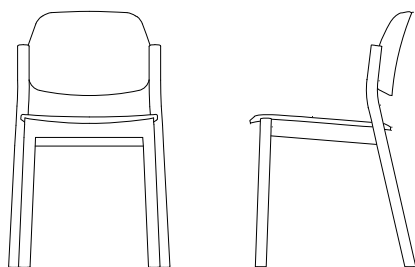

Depth	Width	Height
19.5	19.25	30.75

Core Product	Core Code	List Price
Side Chair - Beech	JY02-10	894

Standard with Core Product

Non-marring Glides

Textile Yardage	Seat
Total: .65	.65

List Price by Textile Grade*

	COM / 1	2	3	4	5	6	7	8	9	10	11	12	13	14	15
JY02-10-UPH	1192	1199	1209	1216	1223	1232	1243	1255	1268	1286	1308	1332	1366	1414	1462

Options	Code	List Price Add
Upholstered Seat	UPH	See above
Clear Over Beech	WCB	0
Stain Finishes	WGB/WOB/WWB/WBB/WBA	73
Painted Wood	PEW/PCY/PFG/POB/PBO/PSG/PDP	105

Notes

For step-by-step specifications and quotes, access our live quote tool online at → [Quotes](#)

April

ADA Stool

Designed by Jun Yasumoto, 2022

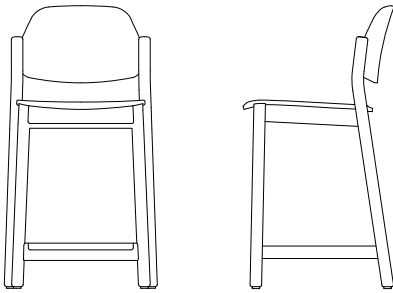

Depth	Width	Height
18	18.5	34

Core Product	Core Code	List Price
ADA Height Stool - Beech	JY02-15	995

Standard with Core Product

- Glides
- Stainless Steel Footrail

Textile Yardage	Seat
Total: .65	.65

List Price by Textile Grade*

	COM / 1	2	3	4	5	6	7	8	9	10	11	12	13	14	15
JY02-15-UPH	1293	1300	1310	1317	1324	1333	1344	1356	1369	1387	1409	1433	1467	1515	1563

Options	Code	List Price Add
Upholstered Seat	UPH	See above
Clear Over Beech	WCB	0
Stain Finishes	WGB/WOB/WWB/WBB/WBA	83
Painted Wood	PEW/PCY/PFG/POB/PBO/PSG/PDP	113

Notes

For step-by-step specifications and quotes, access our live quote tool online at → [Quotes](#)

April

Counter Stool

Designed by Jun Yasumoto, 2022

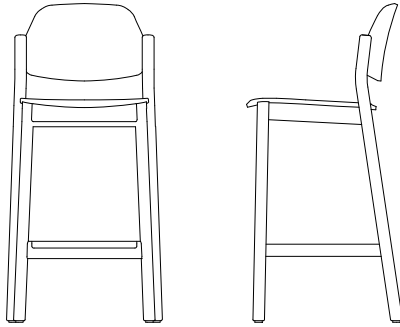

Depth	Width	Height
18	18.5	38

Core Product	Core Code	List Price
Counter Stool - Beech	JY02-16	995

Standard with Core Product

- Glides
- Stainless Steel Footrail

Textile Yardage	Seat
Total: .65	.65

List Price by Textile Grade*

	COM / 1	2	3	4	5	6	7	8	9	10	11	12	13	14	15
JY02-16-UPH	1293	1300	1310	1317	1324	1333	1344	1356	1369	1387	1409	1433	1467	1515	1563

Options	Code	List Price Add
Upholstered Seat	UPH	See above
Clear Over Beech	WCB	0
Stain Finishes	WGB/WOB/WWB/WBB/WBA	83
Painted Wood	PEW/PCY/PFG/POB/PBO/PSG/PDP	115

Notes

For step-by-step specifications and quotes, access our live quote tool online at → [Quotes](#)

April

Bar Stool

Designed by Jun Yasumoto, 2022

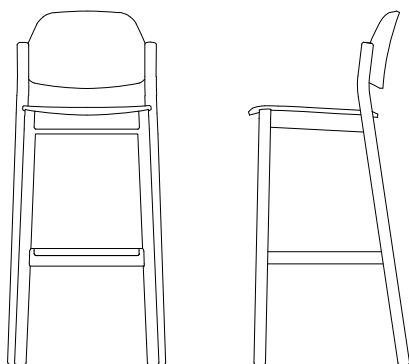

Depth	Width	Height
18	18.75	42.25

Core Product	Core Code	List Price
Bar Stool - Beech	JY02-17	1005

Standard with Core Product

- Glides
- Stainless Steel Footrail

Textile Yardage	Seat
Total: .65	.65

List Price by Textile Grade*

	COM / 1	2	3	4	5	6	7	8	9	10	11	12	13	14	15
JY02-17-UPH	1303	1310	1320	1327	1334	1343	1354	1366	1379	1397	1419	1443	1477	1525	1573

Options	Code	List Price Add
Upholstered Seat	UPH	See above
Clear over Beech	WCB	0
Stain Finishes	WGB/WOB/WWB/WBB/WBA	83
Painted Wood	PEW/PCY/PFG/POB/PBO/PSG/PDP	115

Notes

For step-by-step specifications and quotes, access our live quote tool online at → [Quotes](#)

April

Bar Stool with Low Back

Designed by Jun Yasumoto, 2022

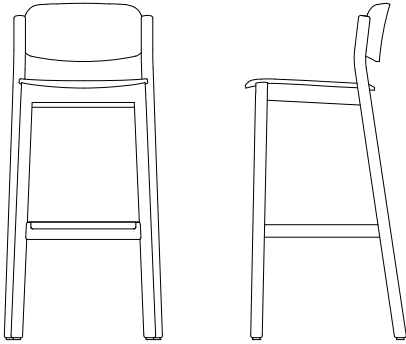

Depth	Width	Height
18	18.75	40.25

Core Product	Core Code	List Price
Bar Stool with Low Back - Beech	JY02-18	1005

Standard with Core Product

- Glides
- Stainless Steel Footrail

Textile Yardage	Seat
Total: .65	.65

List Price by Textile Grade*

	COM / 1	2	3	4	5	6	7	8	9	10	11	12	13	14	15
JY02-18-UPH	1303	1310	1320	1327	1334	1343	1354	1366	1379	1397	1419	1443	1477	1525	1573

Options	Code	List Price Add
Upholstered Seat	UPH	See above
Clear Over Beech	WCB	0
Stain Finishes	WGB/WOB/WWB/WBB/WBA	83
Painted Wood	PEW/PCY/PFG/POB/PBO/PSG/PDP	116

Notes

For step-by-step specifications and quotes, access our live quote tool online at → [Quotes](#)

B-Side

Personal Table

Designed by Standard Issue, 2024

Made in the USA.

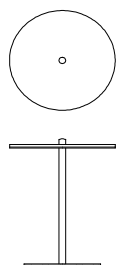

Depth	Width	Height
18"	18"	22"

Core Product	Core Code	List Price
Personal Table	MM03-T1	753

Standard with Core Product

Two Sided Top

Powder Coated Steel and Aluminum Frame

Non-marring glides

Options

	Code	List Price Add
Top Options		
Forbo Linoleum	FTT	525
Wood Veneer (Ash)	VTA	
Clear Finish	WCA/WCW	613
Stain Finish	WOA/WWA/WGA/WNP/WBA	651
Wood Veneer (Walnut)	VTW	648
Solid Surface		
Yukon Riverstone	STS-YUS	613
Black Onyx Mirage	STS-BLS	613
Hidden Space	STS-HIS	613
Kimberlite	STS-KIS	700
Cork	CTT-CNC	910
	CTT-CDK	910
Laminate	LTT-LTF	525
	LTT-LTP	525
	LTT-LTW	525
	LTT-LTA	525
Really	RTT-RCW	945
	RTT-RBD	945

Specifiable Finishes

Linoleum	Choose from Forbo linoleum products on page 7
Metal	Choose from Memo Metal Powder Coat Finishes on page 7
Wood	Choose from Memo Wood Finishes on page 7
Solid Surface	Choose from Memo Solid Surface Finishes on page 7
Cork	Choose from Memo Cork Finishes on page 7
Laminate	Choose from Memo Laminate Finishes on page 7
Really	Choose from Memo Really Finishes on page 7

Notes

For step-by-step specifications and quotes, access our live quote tool online at → [Quotes](#)

B-Side

End Table

Designed by Standard Issue, 2024

Made in the USA.

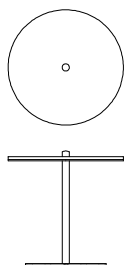

Depth	Width	Height
20"	20"	19"

Core Product	Core Code	List Price
End Table	MM03-T2	798

Standard with Core Product

Two Sided Top

Powder Coated Steel and Aluminum Frame

Non-marring glides

Options

	Code	List Price Add
Top Options		
Forbo Linoleum	FTT	578
Wood Veneer (Ash)	VTA	
Clear Finish	WCA/WCW	700
Stain Finish	WOA/WWA/WGA/WNP/WBA	757
Wood Veneer (Walnut)	VTW	753
Solid Surface		
Yukon Riverstone	STS-YUS	700
Black Onyx Mirage	STS-BLS	700
Hidden Space	STS-HIS	700
Kimberlite	STS-KIS	805
Cork	CTT-CNC	945
	CTT-CDK	945
Laminate	LTT-LTF	578
	LTT-LTP	578
	LTT-LTW	578
	LTT-LTA	578
Really	RTT-RCW	980
	RTT-RBD	980

Specifiable Finishes

- Linoleum Choose from Forbo linoleum products on page 7
- Metal Choose from Memo Metal Powder Coat Finishes on page 7
- Wood Choose from Memo Wood Finishes on page 7
- Solid Surface Choose from Memo Solid Surface Finishes on page 7
- Cork Choose from Memo Cork Finishes on page 7
- Laminate Choose from Memo Laminate Finishes on page 7
- Really Choose from Memo Really Finishes on page 7

Notes

For step-by-step specifications and quotes, access our live quote tool online at → [Quotes](#)

B-Side

Coffee Table
Designed by Standard Issue, 2024
Made in the USA.

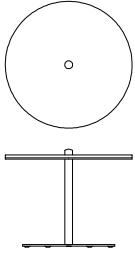

Depth	Width	Height
22"	22"	16"

Core Product	Core Code	List Price
Coffee Table	MM03-T3	865

Standard with Core Product

Two Sided Top
Powder Coated Steel and Aluminum Frame
Non-marring glides

Options

	Code	List Price Add
Top Options		
Forbo Linoleum	FTT	630
Wood Veneer (Ash)	VTA	
Clear Finish	WCA/WCW	788
Stain Finish	WOA/WWA/WGA/WNP/WBA	864
Wood Veneer (Walnut)	VTW	875
Solid Surface		
Yukon Riverstone	STS-YUS	788
Black Onyx Mirage	STS-BLS	788
Hidden Space	STS-HIS	788
Kimberlite	STS-KIS	980
Cork	CTT-CNC	980
	CTT-CDK	980
Laminate	LTT-LTF	630
	LTT-LTP	630
	LTT-LTW	630
	LTT-LTA	630
Really	RTT-RCW	1015
	RTT-RBD	1015

Specifiable Finishes

- Linoleum Choose from Forbo linoleum products on page 7
- Metal Choose from Memo Metal Powder Coat Finishes on page 7
- Wood Choose from Memo Wood Finishes on page 7
- Solid Surface Choose from Memo Solid Surface Finishes on page 7
- Cork Choose from Memo Cork Finishes on page 7
- Laminate Choose from Memo Laminate Finishes on page 7
- Really Choose from Memo Really Finishes on page 7

Notes

For step-by-step specifications and quotes, access our live quote tool online at → [Quotes](#)

Chord

Personal Table

Designed by Standard Issue, 2019

Made in the USA.

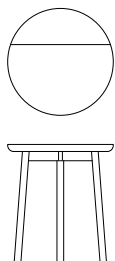

Depth	Width	Height
18"	18"	20.5"

Core Product

Personal Table

Core Code

MM01-T1

List Price

1136

Standard with Core Product

Glides

Open Tray Surface

Powder Coated Steel Frame

Options

	Code	List Price Add
Large Insert Options		
Forbo Linoleum	FTL	301
Wood Veneer (Ash)	VAL	384
Clear Finish	WCA/WCW	0
Stain Finish	WOA/WWA/WGA/WNP/WBA	38
Wood Veneer (Walnut)	VWL	438
Small Insert Options		
No Insert (void)	XXS	0
Forbo Linoleum	FTS	9
Wood Veneer (Ash)	VAS	36
Clear Finish	WCA/WCW	0
Stain Finish	WOA/WWA/WGA/WNP/WBA	38
Wood Veneer (Walnut)	VWS	59
Solid Surface		
Yukon Riverstone	STS-YUS	329
Black Onyx Mirage	STS-BLS	329
Hidden Space	STS-HIS	329
Kimberlite	STS-KIS	435

Specifiable Finishes

Linoleum	Choose from Forbo linoleum products on page 7
Metal	Choose from Memo Metal Powder Coat Finishes on page 7
Wood	Choose from Memo Wood Finishes on page 7
Solid Surface	Choose from Memo Solid Surface Finishes on page 7

Notes

For step-by-step specifications and quotes, access our live quote tool online at → [Quotes](#)

Chord

Side Table

Designed by Standard Issue, 2019

Made in the USA.

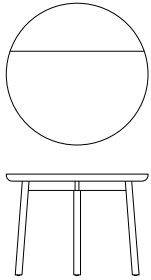

Depth	Width	Height
24"	24"	17.25"

Core Product

Side Table

Core Code

MM01-T2

List Price

1203

Standard with Core Product

Glides

Open Tray Surface

Powder Coated Steel Frame

Options

	Code	List Price Add
Large Insert Options		
Forbo Linoleum	FTL	367
Wood Veneer (Ash)	VAL	530
Clear Finish	WCA/WCW	0
Stain Finish	WOA/WWA/WGA/WNP/WBA	57
Wood Veneer (Walnut)	VWL	620
Small Insert Options		
No Insert (void)	XXS	0
Forbo Linoleum	FTS	8
Wood Veneer (Ash)	VAS	26
Clear Finish	WCA/WCW	0
Stain Finish	WOA/WWA/WGA/WNP/WBA	57
Wood Veneer (Walnut)	VWS	53
Solid Surface		
Yukon Riverstone	STS-YUS	407
Black Onyx Mirage	STS-BLS	407
Hidden Space	STS-HIS	407
Kimberlite	STS-KIS	559

Specifiable Finishes

Linoleum	Choose from Forbo linoleum products on page 7
Metal	Choose from Memo Metal Powder Coat Finishes on page 7
Wood	Choose from Memo Wood Finishes on page 7
Solid Surface	Choose from Memo Solid Surface Finishes on page 7

Notes

For step-by-step specifications and quotes, access our live quote tool online at → [Quotes](#)

Chord

Coffee Table

Designed by Standard Issue, 2019

Made in the USA.

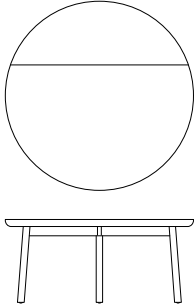

Depth	Width	Height
32"	32"	14.25"

Core Product

Coffee Table

Core Code

MM01-T3

List Price

1363

Standard with Core Product

Glides

Open Tray Surface

Powder Coated Steel Frame

Options

	Code	List Price Add
Large Insert Options		
Forbo Linoleum	FTL	464
Wood Veneer (Ash)	VAL	722
Clear Finish	WCA/WCW	0
Stain Finish	WOA/WWA/WGA/WNP/WBA	76
Wood Veneer (Walnut)	VWL	857
Small Insert Options		
No Insert (void)	XXS	0
Forbo Linoleum	FTS	36
Wood Veneer (Ash)	VAS	50
Clear Finish	WCA/WCW	0
Stain Finish	WOA/WWA/WGA/WNP/WBA	76
Wood Veneer (Walnut)	VWS	85
Solid Surface		
Yukon Riverstone	STS-YUS	634
Black Onyx Mirage	STS-BLS	634
Hidden Space	STS-HIS	634
Kimberlite	STS-KIS	900

Specifiable Finishes

Linoleum	Choose from Forbo linoleum products on page 7
Metal	Choose from Memo Metal Powder Coat Finishes on page 7
Wood	Choose from Memo Wood Finishes on page 7
Solid Surface	Choose from Memo Solid Surface Finishes on page 7

Notes

For step-by-step specifications and quotes, access our live quote tool online at → [Quotes](#)

Chroma

Lounge

Designed by Harri Koskinen, 2019

Made in the USA.

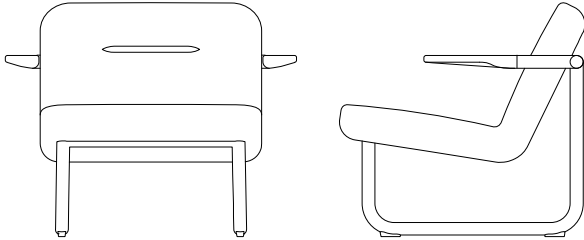

Depth	Width	Height
28.75"	33.75"	27.5"

Core Product

Lounge

Core Code

HK01-01

Textile Yardage

Total: 2.0

Seat Back Arms

n/a n/a n/a

List Price by Textile Grade

	COM / 1	2	3	4	5	6	7	8	9	10	11	12	13	14	15
HK01-01	3269	3291	3321	3341	3363	3391	3425	3461	3503	3559	3625	3699	3803	3951	4099

Standard with Core Product

Ash Arms

Non-Marring Glides

High Resilience Polyurethane Foam

Options

Component	Code	List Price Add
Ash Arms with Stain	WOA/WBA	21
	WWA	56
	WGA/WNP/WBA	91
Walnut Arms	WCW	294

Specifiable Finishes

Metal Choose from Memo Metal Powder Coat Finishes on page 7

Textiles Choose from Camira, Maharam, or Kvadrat textiles on page 80, or contact Memo for assistance with COM fabrics

Wood Choose from Memo Wood Finishes on page 7

Notes

Due to the continuous seat and back, multiple textiles are not permitted on Chroma Lounge

For step-by-step specifications and quotes, access our live quote tool online at → Quotes

Chroma

Lounge, Armless

Designed by Harri Koskinen, 2019

Made in the USA.

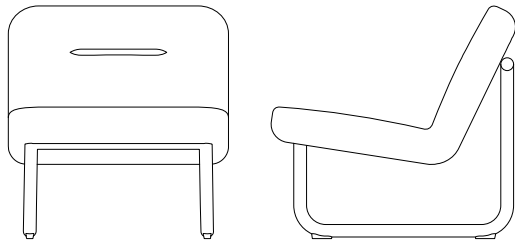

Depth	Width	Height
28.75"	26"	27.5"

Core Product

Lounge, Armless

Core Code

HK01-09

Textile Yardage

Total: 2.0

Seat	Back	Arms
n/a	n/a	n/a

List Price by Textile Grade

	COM / 1	2	3	4	5	6	7	8	9	10	11	12	13	14	15
HK01-09	2699	2721	2751	2771	2793	2821	2855	2891	2933	2989	3055	3129	3233	3381	3529

Standard with Core Product

Non-Marring Glides

High Resilience Polyurethane Foam

Specifiable Finishes

Metal Choose from Memo Metal Powder Coat Finishes on page 7

Textiles Choose from Camira, Maharam, or Kvadrat textiles on page 80, or contact Memo for assistance with COM fabrics

Notes

Due to the continuous seat and back, multiple textiles are not permitted on Chroma Lounge

For step-by-step specifications and quotes, access our live quote tool online at → Quotes

Chroma

Lounge, Swivel

Designed by Harri Koskinen, 2019

Made in the USA.

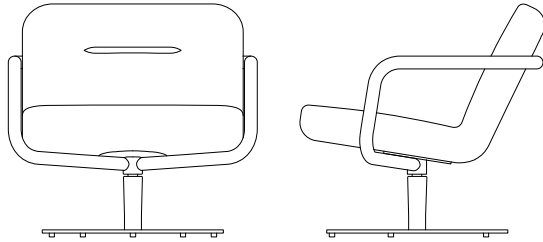

Depth	Width	Height
28.75"	29.25"	27.5"

Core Product

Lounge, Swivel

Core Code

HK01-11

Textile Yardage

Total: 2.0

Seat Back Arms

n/a n/a n/a

List Price by Textile Grade

	COM / 1	2	3	4	5	6	7	8	9	10	11	12	13	14	15
HK01-11	3678	3700	3730	3750	3772	3800	3834	3870	3912	3968	4034	4108	4212	4360	4508

Standard with Core Product

Free swivel base

High Resilience Polyurethane Foam

Non-Marring Glides

Specifiable Finishes

Metal

Choose from Memo Metal Powder Coat Finishes on page 7

Textiles

Choose from Camira, Maharam, or Kvadrat textiles on page 80, or contact Memo for assistance with COM fabrics

Notes

Due to the continuous seat and back, multiple textiles are not permitted on Chroma Lounge

For step-by-step specifications and quotes, access our live quote tool online at → [Quotes](#)

Chroma

Ottoman - 17

Designed by Harri Koskinen, 2019

Made in the USA.

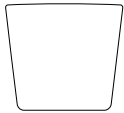
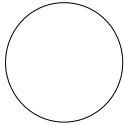

Depth	Width	Height
17.25"	17.25"	15.5"

Core Product

Ottoman

Core Code

HK01-00

Textile Yardage	Seat	Back	Arms
Total: 1.25	1.25	n/a	n/a

List Price by Textile Grade

	COM / 1	2	3	4	5	6	7	8	9	10	11	12	13	14	15
HK01-00	1050	1064	1083	1095	1109	1126	1148	1170	1196	1231	1273	1319	1384	1476	1569

Standard with Core Product

High Resilience Polyurethane Foam

Non-Marring Glides

Specifiable Finishes

Textiles Choose from Camira, Maharam, or Kvadrat textiles on page 80, or contact Memo for assistance with COM fabrics

Notes

For step-by-step specifications and quotes, access our live quote tool online at → Quotes

Chroma

Ottoman - 24

Designed by Harri Koskinen, 2019

Made in the USA.

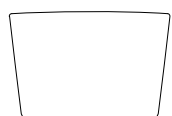
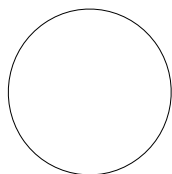

Depth	Width	Height
24"	24"	15.5"

Core Product

Ottoman

Core Code

HK01-24

Textile Yardage

Total: 1.5

Seat Back Arms

1.5 n/a n/a

List Price by Textile Grade

	COM / 1	2	3	4	5	6	7	8	9	10	11	12	13	14	15
HK01-24	1372	1389	1411	1426	1443	1464	1489	1516	1548	1590	1639	1695	1773	1884	1995

Standard with Core Product

High Resilience Polyurethane Foam

Non-Marring Glides

Specifiable Finishes

Textiles

Choose from Camira, Maharam, or Kvadrat textiles on page 80, or contact Memo for assistance with COM fabrics

Notes

For step-by-step specifications and quotes, access our live quote tool online at → [Quotes](#)

Chroma

Ottoman - 29

Designed by Harri Koskinen, 2019

Made in the USA.

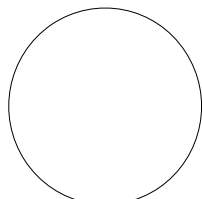

Depth	Width	Height
29"	29"	15.5"

Core Product

Ottoman

Core Code

HK01-29

Textile Yardage

Total: 2

Seat	Back	Arms
2	n/a	n/a

List Price by Textile Grade

	COM / 1	2	3	4	5	6	7	8	9	10	11	12	13	14	15
HK01-29	1585	1607	1637	1657	1679	1707	1741	1777	1819	1875	1941	2015	2119	2267	2415

Standard with Core Product

High Resilience Polyurethane Foam

Non-Marring Glides

Specifiable Finishes

Textiles

Choose from Camira, Maharam, or Kvadrat textiles on page 80, or contact Memo for assistance with COM fabrics

Notes

For step-by-step specifications and quotes, access our live quote tool online at → Quotes

Chroma

Ottoman - 38

Designed by Harri Koskinen, 2019

Made in the USA.

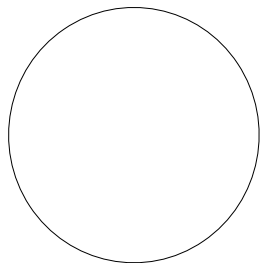

Depth	Width	Height
38"	38"	15.5"

Core Product

Ottoman

Core Code

HK01-38

Textile Yardage

Total: 2.25

Seat Back Arms

2.25 n/a n/a

List Price by Textile Grade

	COM / 1	2	3	4	5	6	7	8	9	10	11	12	13	14	15
HK01-38	2066	2091	2125	2147	2172	2203	2242	2282	2329	2392	2467	2550	2667	2833	3000

Standard with Core Product

High Resilience Polyurethane Foam

Non-Marring Glides

Specifiable Finishes

Textiles

Choose from Camira, Maharam, or Kvadrat textiles on page 80, or contact Memo for assistance with COM fabrics

Notes

For step-by-step specifications and quotes, access our live quote tool online at → Quotes

Ida

Table

Designed by Nina Cho, 2022

Made in the USA.

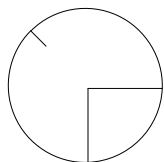

Depth	Width	Height
32"	32"	13.75"

Core Product

Table

Core Code

NC01-T1

List Price

5676

Options

	Code	List Price Add
Shelf Insert Options		
No Shelf Insert	XXS	0
Solid Wood Insert (Ash)	WAS	279
Solid Wood Insert (Ash + Stain) WOA/WWA/WGA/WNP/WBA		93
Solid Wood Insert (Walnut)	WWS	434
Stone Insert (Marble)	STS	825

Specifiable Finishes

Metal	Choose from Memo Metal Powder Coat Finishes on page 7
Wood (shelf)	Choose from Memo Wood Finishes on page 7

Notes

For step-by-step specifications and quotes, access our live quote tool online at → [Quotes](#)

Kino

Stool

Designed by Kensaku Oshiro, 2020

Made in the Canada, Assembled in the USA.

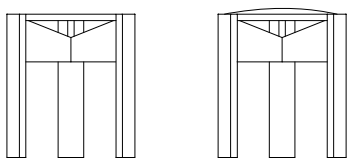
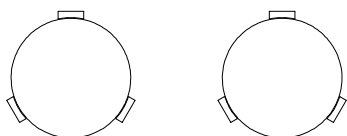

Depth	Width	Height
15.75"	15.75"	17.75 / 18.25"

Core Product	Core Code	List Price
Stool - Ash	KN01-S1-A	587
Stool - Walnut	KN01-S1-W	787

Standard with Core Product

- Glides
- Solid Wood Frame
- Solid Wood Top

Textile Yardage	Seat
Total: .6	.6

List Price by Textile Grade*

	COM / 1	2	3	4	5	6	7	8	9	10	11	12	13	14	15
KN01-S1-A-UTT	816	822	831	837	844	852	863	873	886	903	923	945	976	1020	1065
KN01-S1-W-UTT	1024	1030	1039	1045	1052	1060	1071	1081	1094	1111	1131	1153	1184	1228	1273

Standard with Core Product

- Non-Marring Glides
- High Resilience Polyurethane Foam

Options and Notes overleaf

Options

	Code	List Price Add
Upholstered Top	UTT	See previous page
Clear Finish (by species)	WCA	0
Stain Finish - Wood Top	WOA/WBA	27
	WWA	44
	WGA/WNP	71
Stain Finish - Upholstered Top	WOA/WBA	27
	WWA	44
	WGA/WNP	71

Specifiable Finishes

- Wood Choose from Memo Wood Finishes on Page 7
- Textiles Choose from Camira, Maharam, or Kvadrat textiles on page 80, or contact Memo for assistance with COM fabrics

Notes

For step-by-step specifications and quotes, access our live quote tool online at → [Quotes](#)

Maru Benches

Three Slat Bench - 3/4-Length
Designed by Studio Gorm, 2020
Made in the USA.



Depth	Width	Height
17.75"	65.5"	17"

Core Product

Three Slat Bench - 3/4-Length - Ash

Core Code

SG03-IND-S3-66W-A

Standard with Core Product

Glides
Solid Ash Wood Frame

Upholstery Configurations

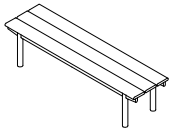

Configuration 1.3-S
(none)

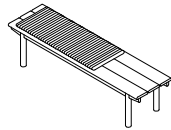

Configuration 2.3-S
-PC2

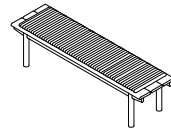

Configuration 3.3-S
-P60D2

Textile Yardage

Pad, Long (60"): 2.75 (each)
Pad, Standard: 1.50 (each)

Upholstery Configurations - List Price by Textile Grade

	Base	COM / 1	2	3	4	5	6	7	8	9	10	11	12	13	14	15
Configuration 1.3-S	2759	n/a	n/a	n/a	n/a	n/a	n/a	n/a	n/a	n/a	n/a	n/a	n/a	n/a	n/a	n/a
Configuration 2.3-S		3401	3418	3440	3455	3472	3493	3518	3545	3577	3619	3668	3724	3802	3913	4024
Configuration 3.3-S		3563	3585	3615	3635	3657	3685	3719	3755	3797	3853	3919	3993	4097	4245	4393

Options and Notes overleaf

Options

Wood Species	Code	List Price Add
Ash	A	0
Walnut	W	1694

Wood Finishes

Clear over Ash/Walnut	WCA/WCW	0
Ash with Stain Finish	WOA/WWA	125

Accessories (see below for visuals)

Table, Round, Ash Veneer	T1	527
Table, Obround, Ash Veneer	T2	580
Power Module/s	PM1/PM2	350/805

Other Options

Veneer Round Table Top(s), Walnut	VTW	85 (per table)
Veneer Obround Table Top(s), Walnut	VTW	94 (per table)
Veneer Round Table Top(s), Ash with Stain	WOA/WWA	53 (per table)
Veneer Obround Table Top(s), Ash with Stain	WOA/WWA	58 (per table)

Specifiable Finishes

Textiles Choose from Maharam, Kvadrat, or Camira textiles on page 80, contact Memo for assistance with COM fabrics
 Wood/Veneer Choose from Memo Wood Finishes on page 7

Notes

For step-by-step specifications and quotes, access our live quote tool online at → Quotes

Accessories (visuals)

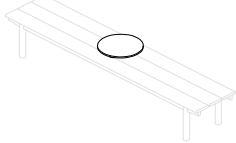

Table, Round
See below for locations

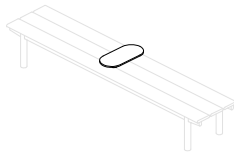

Table, Obround
See below for locations

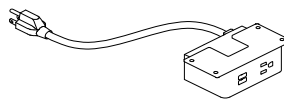

Power Module
1-Power, 2-USB

Table Locations (Round Table shown)

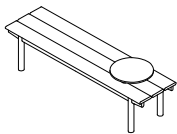

-T1F2
For Configurations 1.3-S

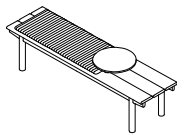

-T1E2
For Configuration 2.3-S

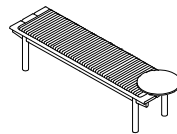

-T1G2
For Configuration 3.3-S

Maru Benches

Three Slat Bench

Designed by Studio Gorm, 2020

Made in the USA.



Depth	Width	Height
17.75"	85.5"	17"

Core Product

Three Slat Bench - Ash

Core Code

SG03-IND-S3-86W-A

Standard with Core Product

Glides

Solid Ash Wood Frame

Upholstery Configurations

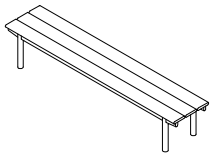

Configuration 1.3
(none)

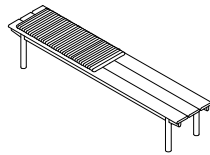

Configuration 2.3
-PC2

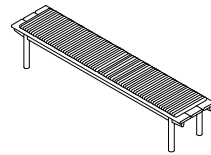

Configuration 3.3
-PC2-PG2

Textile Yardage

Pad: 1.50 (each)

Upholstery Configurations - List Price by Textile Grade

	Base	COM / 1	2	3	4	5	6	7	8	9	10	11	12	13	14	15
Configuration 1.3	3343	n/a	n/a	n/a	n/a	n/a	n/a	n/a	n/a	n/a	n/a	n/a	n/a	n/a	n/a	n/a
Configuration 2.3		3985	4002	4024	4039	4056	4077	4102	4129	4161	4203	4252	4308	4386	4497	4608
Configuration 3.3		4627	4660	4705	4735	4768	4810	4861	4915	4978	5062	5161	5272	5428	5650	5872

Options and Notes overleaf

Options

Wood Species	Code	List Price Add
Ash	A	0
Walnut	W	1764

Wood Finishes

Clear over Ash/Walnut	WCA/WCW	0
Ash with Stain Finish	WOA/WWA	149

Accessories (see below for visuals)

Table, Round, Ash Veneer	T1	527
Table, Obround, Ash Veneer	T2	580
Power Module/s	PM1/PM2	350/805

Other Options

Veneer Round Table Top(s), Walnut	VTW	85 (per table)
Veneer Obround Table Top(s), Walnut	VTW	94 (per table)
Veneer Round Table Top(s), Ash with Stain	WOA/WWA	53 (per table)
Veneer Obround Table Top(s), Ash with Stain	WOA/WWA	58 (per table)

Specifiable Finishes

Textiles Choose from Maharam, Kvadrat, or Camira textiles on page 80, contact Memo for assistance with COM fabrics
Wood/Veneer Choose from Memo Wood Finishes on page 7

Notes

For step-by-step specifications and quotes, access our live quote tool online at → Quotes

Accessories (visuals)

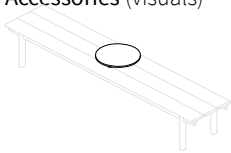

Table, Round
See below for locations

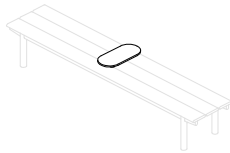

Table, Obround
See below for locations

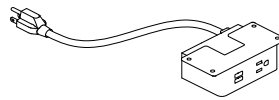

Power Module
1-Power, 2-USB

Table Locations (Round Table shown)

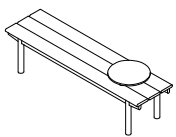

-T1F2
For Configurations 1.3-S

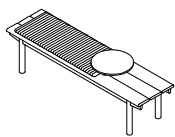

-T1E2
For Configuration 2.3-S

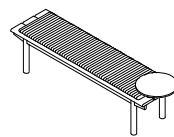

-T1G2
For Configuration 3.3-S

Maru Benches

Five Slat Bench

Designed by Studio Gorm, 2020

Made in the USA.

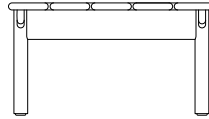

Depth	Width	Height
29.75"	85.5"	17"

Core Product

Five Slat Bench -Ash

Core Code

SG03-IND-S5-86W-A

Standard with Core Product

Glides

Solid Ash Wood Frame

Upholstery Configurations

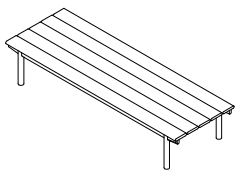

Configuration 1.5
(none)

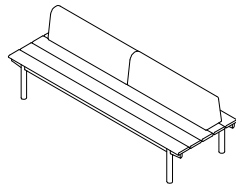

Configuration 2.5
-BC2-BG2

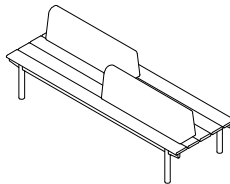

Configuration 3.5
-BC2-BG4

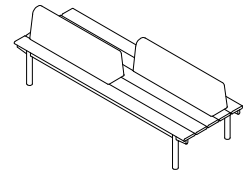

Configuration 4.5
-BC4-BG2

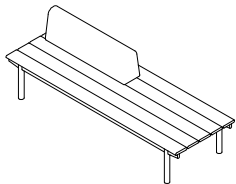

Configuration 5.5
-BC2

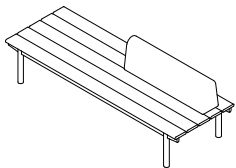

Configuration 6.5
-BG2

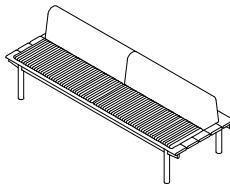

Configuration 7.5
-BC2-BG2-PC4-PG4

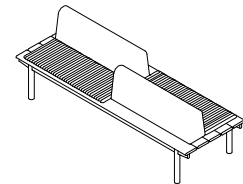

Configuration 8.5
-BC2-BG4-PC4-PG2

More Configurations, Pricing, Options, and Notes overleaf

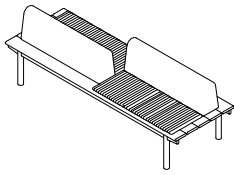

Configuration 9.5
-BG4-BG2-PC2-PG4

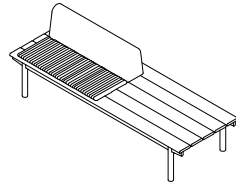

Configuration 10.5
-BC2-PC4

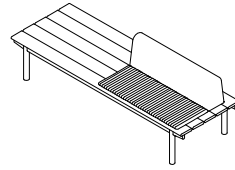

Configuration 11.5
-BG2-PG4

Textile Yardage

Bolster: 1.25 (each)
Pad: 2.75 (each)

Upholstery Configurations - List Price by Textile Grade*

	Base	COM / 1	2	3	4	5	6	7	8	9	10	11	12	13	14	15
Configuration 1.5	4679	n/a	n/a	n/a	n/a	n/a	n/a	n/a	n/a	n/a	n/a	n/a	n/a	n/a	n/a	n/a
Configuration 2.5		6003	6031	6068	6093	6121	6156	6198	6243	6296	6366	6448	6541	6671	6856	7041
Configuration 3.5		6003	6031	6068	6093	6121	6156	6198	6243	6296	6366	6448	6541	6671	6856	7041
Configuration 4.5		6003	6031	6068	6093	6121	6156	6198	6243	6296	6366	6448	6541	6671	6856	7041
Configuration 5.5		5341	5355	5374	5386	5400	5417	5439	5461	5487	5522	5564	5610	5675	5767	5860
Configuration 6.5		5341	5355	5374	5386	5400	5417	5439	5461	5487	5522	5564	5610	5675	5767	5860
Configuration 7.5		7287	7348	7430	7485	7546	7623	7716	7815	7931	8085	8266	8470	8756	9163	9570
Configuration 8.5		7287	7348	7430	7485	7546	7623	7716	7815	7931	8085	8266	8470	8756	9163	9570
Configuration 9.5		7287	7348	7430	7485	7546	7623	7716	7815	7931	8085	8266	8470	8756	9163	9570
Configuration 10.5		5983	6013	6055	6082	6112	6151	6198	6247	6305	6382	6473	6574	6717	6921	7124
Configuration 11.5		5983	6013	6055	6082	6112	6151	6198	6247	6305	6382	6473	6574	6717	6921	7124

*Pricing assumes single textile selection for pads and bolsters. For multiple textiles please visit → Quotes

Options

Wood Species	Code	List Price Add
Ash	A	0
Walnut	W	2349

Wood Finishes	Code	List Price Add
Clear over Ash/Walnut	WCA/WCW	0
Ash with Stain Finish	WOA/WWA	215

Accessories (see below for visuals)	Code	List Price Add
Dowel Partition, Ash	SCR1A	3053
Dowel Partition, Ash with Stain Finish	WOA/WWA	600
Table, Round, Ash Veneer	T1	527
Table, Obround, Ash Veneer	T2	580
Power Module/s	PM1/PM2	350/805

More Options, Visuals, and Notes overleaf

Other Options

Veneer Round Table Top(s), Walnut	VTW	85 (per table)
Veneer Obround Table Top(s), Walnut	VTW	94 (per table)
Veneer Round Table Top(s), Ash with Stain	WOA/WWA	53 (per table)
Veneer Obround Table Top(s), Ash with Stain	WOA/WWA	58 (per table)

Specifiable Finishes

Textiles Choose from Maharam, Kvadrat, or Camira textiles on page 80, contact Memo for assistance with COM fabrics
 Wood/Veneer Choose from Memo Wood Finishes on page 7

Notes

For step-by-step specifications and quotes, access our live quote tool online at → [Quotes](#)

Accessories (visuals)

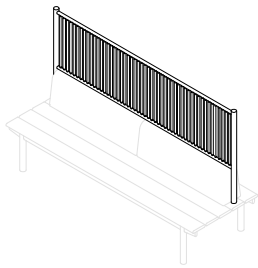

Dowel Partition
Only for Configurations 2.5, 7.5

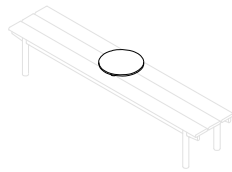

Table, Round
See below for locations

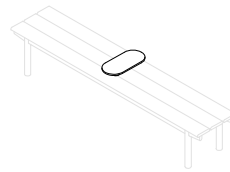

Table, Obround
See below for locations

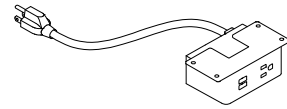

Power Module
1-Power, 2-USB

Table Locations (Round Table shown)

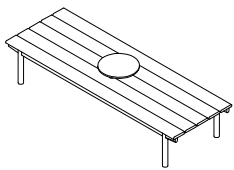

-T1E3
For Configuration 1.5

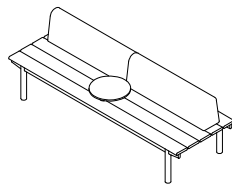

-T1E4
For Configurations 2.5, 5.5, 6.5, 7.5, 10.5, 11.5

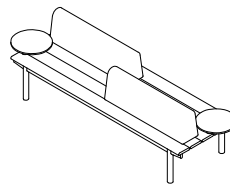

-T1A4-T1I2
For Configuration 3.5, 8.5

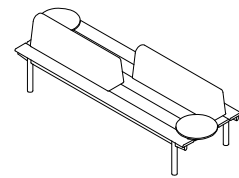

-T1A2-T1I4
For Configuration 4.5, 9.5

Maru Benches

Seven Slat Bench

Designed by Studio Gorm, 2020

Made in the USA.



Depth	Width	Height
41.75"	85.5"	17"

Core Product

Seven Slat Bench - Ash

Core Code

SG03-IND-S7-86W-A

Standard with Core Product

Glides

Solid Ash Wood Frame

Upholstery Configurations

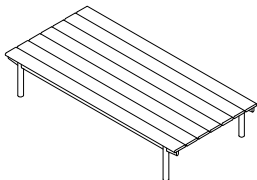

Configuration 1.7
(none)

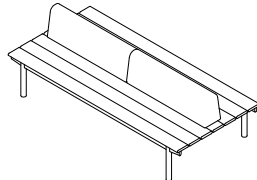

Configuration 2.7
-BC4-BG4

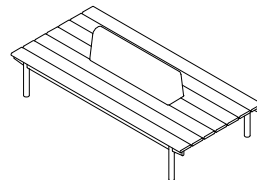

Configuration 3.7
-BE4

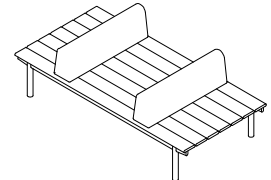

Configuration 4.7
-BC4R-BG4R

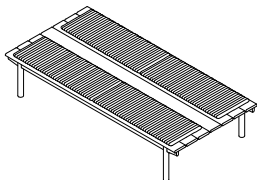

Configuration 5.7
-PC2-PC6-PG2-PG6

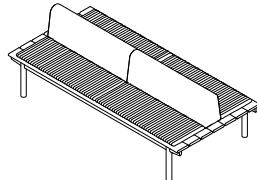

Configuration 6.7
-BC4-BG4-PC2-PC6-PG2-PG6

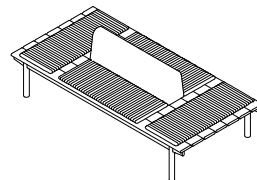

Configuration 7.7
-BE4-PB4R-PE2-PE6-PH4R

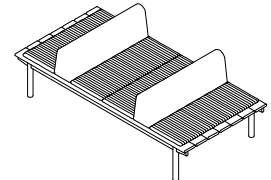

Configuration 8.7
-BC4R-BG4R-PB4R-PD4R-PF4R-PH4R

Pricing, Options, and Notes overleaf

Textile Yardage

Bolster: 1.25 (each)
Pad: 2.75 (each)

Upholstery Configurations - List Price by Textile Grade*

	Base	COM / 1	2	3	4	5	6	7	8	9	10	11	12	13	14	15
Configuration 1.7	6142	n/a	n/a	n/a	n/a	n/a	n/a	n/a	n/a	n/a	n/a	n/a	n/a	n/a	n/a	n/a
Configuration 2.7		7652	7680	7717	7742	7770	7805	7847	7892	7945	8015	8097	8190	8320	8505	8690
Configuration 3.7		6990	7004	7023	7035	7049	7066	7088	7110	7136	7171	7213	7259	7324	7416	7509
Configuration 4.7		7652	7680	7717	7742	7770	7805	7847	7892	7945	8015	8097	8190	8320	8505	8690
Configuration 5.7		8896	8962	9052	9112	9178	9262	9364	9472	9598	9766	9964	10186	10498	10942	11386
Configuration 6.7		10220	10314	10441	10526	10620	10739	10883	11036	11215	11453	11733	12048	12490	13119	13748
Configuration 7.7		9558	9638	9747	9819	9899	10000	10124	10254	10406	10609	10849	11117	11494	12030	12567
Configuration 8.7		10220	10314	10441	10526	10620	10739	10883	11036	11215	11453	11733	12048	12490	13119	13748

*Pricing assumes single textile selection for pads and bolsters. For multiple textiles please visit → Quotes

Options

Wood Species	Code	List Price Add
Ash	A	0
Walnut	W	3386

Wood Finishes	Code	List Price Add
Clear over Ash/Walnut	WCA/WCW	0
Ash with Stain Finish	WOA/WWA	294

Accessories (see following page for visuals)

Dowel Partition, Ash	SCR1A	3053
Dowel Partition, Ash with Stain Finish	WOA/WWA	600
Table, Round, Ash Veneer	T1	527
Table, Obround, Ash Veneer	T2	580
Power Module/s	PM1/PM2	305/805

Other Options	Code	List Price Add
Veneer Round Table Top(s), Walnut	VTW	85 (per table)
Veneer Obround Table Top(s), Walnut	VTW	94 (per table)
Veneer Round Table Top(s), Ash with Stain	WOA/WWA	53 (per table)
Veneer Obround Table Top(s), Ash with Stain	WOA/WWA	58 (per table)

More Options, Visuals, and Notes overleaf

Specifiable Finishes

Textiles

Choose from Maharam, Kvadrat, or Camira textiles on page 80, contact Memo for assistance with COM fabrics

Wood/Veneer

Choose from Memo Wood Finishes on page 7

Notes

For step-by-step specifications and quotes, access our live quote tool online at → [Quotes](#)

Accessories (visuals)

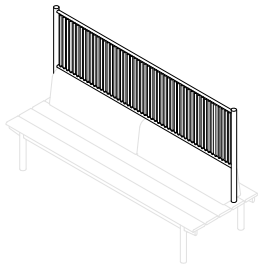

Dowel Partition

Only for Configurations 2.7, 6.7

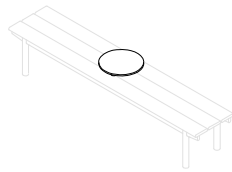

Table, Round

See below for locations

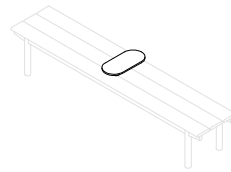

Table, Obround

See below for locations

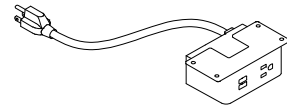

Power Module

1-Power, 2-USB

Table Locations (Round Table shown)

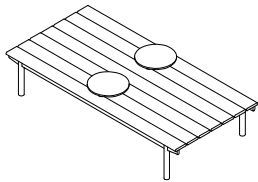

-T1E2-T1E6

For Configurations 1.7, 5.7

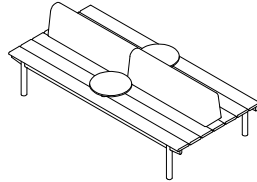

-T1E2-T1E6

For Configurations 2.7, 6.7

Orca

Vertical Screen

Designed by Alex Brokamp , 2020

Made in the USA.

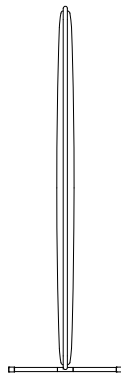
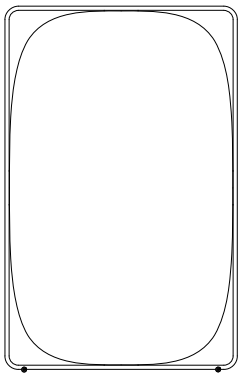
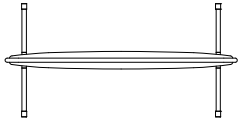

Depth	Width	Height
20"	40.9"	64.3"

Core Product

Vertical Screen

Core Code

AB01-V

List Price by Textile Grade*

	COM / 1	2	3	4	5	6	7	8	9	10	11	12	13	14	15
AB01-V	1859	1900	1957	1994	2035	2088	2152	2219	2298	2403	2527	2665	2860	3138	3415

*Pricing assumes a single textile selection for both sides. For multiple textiles please visit → Quotes

Textiles

AB01 screens are available in select textiles that meet ASTM-E84 Class A Unadhered Testing and are suitable for panel applications.

Choose From:

Camira Quest (Group 3)

Kvadrat Remix (Group 8)

Maharam Murmur (Group 5)

Camira Blaze (Group 7)

Kvadrat Melange Nap (Group 10)

Maharam Flock (Group 8)

Textile Yardage

Side A Side B

Total: 3.75

1.875

1.875

Standard with Core Product

Steel Frame with Black Powdercoat

Upholstered Field

Non-marring glides

Options

Component	Code	List Price Add
Multiple Textiles (Side A / Side B)	TA	140
Casters	CA	84

Specifiable Finishes

Textiles Choose from Camira, Maharam, or Kvadrat textiles on previous page

Notes

Multiple Textile option allows for separate textiles on each side

For step-by-step specifications and quotes, access our live quote tool online at → [Quotes](#)

Orca

Horizontal Screen

Designed by Alex Brokamp , 2020

Made in the USA.

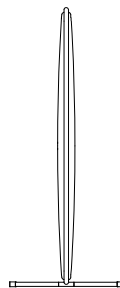
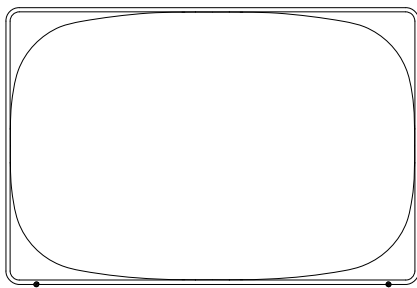
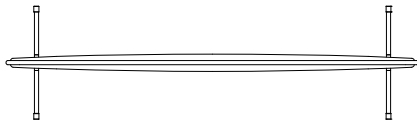

Depth	Width	Height
20"	72.9"	49.3"

Core Product

Horizontal Screen

Core Code

AB01-H

List Price by Textile Grade*

	COM / 1	2	3	4	5	6	7	8	9	10	11	12	13	14	15
AB01-H	2054	2101	2165	2207	2254	2313	2386	2462	2551	2670	2811	2968	3189	3503	3818

Textiles

AB01 screens are available in select textiles that meet ASTM-E84 Class A Unadhered Testing and are suitable for panel applications.

Choose From:

Camira Quest (Group 3)

Kvadrat Remix (Group 8)

Maharam Murmur (Group 5)

Camira Blaze (Group 7)

Kvadrat Melange Nap (Group 10)

Maharam Flock (Group 8)

*Pricing assumes a single textile selection for both sides. For multiple textiles please visit → Quotes

Textile Yardage	Side A	Side B
Total: 4.25	2.125	2.125

Standard with Core Product

Steel Frame with Black Powdercoat

Upholstered Field

Non-marring glides

Options

Component	Code	List Price Add
Multiple Textiles (Side A / Side B)	TA	140
Casters	CA	84

Specifiable Finishes

Textiles Choose from Camira, Maharam, or Kvadrat textiles on previous page

Notes

Multiple Textile option allows for separate textiles on each side

For step-by-step specifications and quotes, access our live quote tool online at → [Quotes](#)

Penna

Lounge

Designed by Studio Gorm, 2019

Made in the USA.

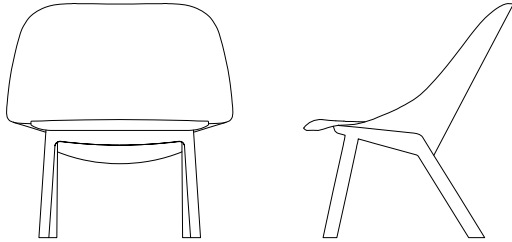

Depth	Width	Height
32"	25.5"	30"

Core Product

Lounge - Ash
Lounge - Walnut

Core Code

SG01-01-A
SG01-01-W

Textile Yardage

Total: 2.5

Seat	Back	Arms
.75	1.75	n/a

List Price by Textile Grade*

	COM / 1	2	3	4	5	6	7	8	9	10	11	12	13	14	15
SG01-01-A	2698	2726	2763	2788	2816	2851	2893	2938	2991	3061	3143	3236	3366	3551	3736
SG01-01-W	3979	4007	4044	4069	4097	4132	4174	4219	4272	4342	4424	4517	4647	4832	5017

*Pricing assumes a single textile selection for seat and back. For multiple textiles please visit → Quotes

Standard with Core Product

Non-Marring Glides

High Resilience Polyurethane Foam

Options

Component	Code	List Price Add
Multiple Textiles (Seat/Back)	TA	140
Stain Finish on Base	WOA/WBA	54
	WWA	90
	WGA/WNP	126

Specifiable Finishes

Textiles Choose from Camira, Maharam, or Kvadrat textiles on page 80, or contact Memo for assistance with COM fabrics
Wood Choose from Memo Wood Finishes on page 7

Notes

Multiple Textile option allows for separate seat and back textiles
For step-by-step specifications and quotes, access our live quote tool online at → Quotes

Penna

Large Round Table

Designed by Studio Gorm, 2019

Made in the USA.

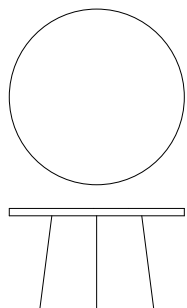

Depth	Width	Height
30"	30"	17.5"

Core Product	Core Code	List Price
Large Round Table - Ash	SG01-T1-A	2255
Large Round Table - Walnut	SG01-T1-W	2459

Standard with Core Product

Glides

Forbo Linoleum Top

Solid Wood Edge Band (finish to match base)

Wood Veneer Base

Options

Component	Code	List Price Add
Forbo Linoleum Top	FTT	0
Wood Veneer Top (Ash)	VTA	171
Wood Veneer Top (Walnut)	VTW	257
Ash with Stain Finish	WOA/WBA	95
	WWA	110
	WGA/WNP	125
Power Module (2-power, 2-USB)	PM1	343

Specifiable Finishes

Linoleum Choose from Forbo linoleum products on page 7

Wood Choose from Memo Wood Finishes on page 7

Notes

For step-by-step specifications and quotes, access our live quote tool online at → Quotes

Penna

Obround Table

Designed by Studio Gorm, 2019

Made in the USA.

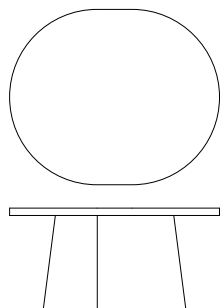

Depth	Width	Height
30"	36"	17.5"

Core Product	Core Code	List Price
Obround Table - Ash	SG01-T2-A	2407
Obround Table - Walnut	SG01-T2-W	2632

Standard with Core Product

- Glides
- Forbo Linoleum Top
- Solid Wood Edge Band (finish to match base)
- Wood Veneer Base

Options

Component	Code	List Price Add
Forbo Linoleum Top	FTT	0
Wood Veneer Top (Ash)	VTA	153
Wood Veneer Top (Walnut)	VTW	280
Ash with Stain Finish	WOA/WBA	100
	WWA	115
	WGA/WNP	130
Power Module (2-power, 2-USB)	PM1	343

Specifiable Finishes

- Linoleum Choose from Forbo linoleum products on page 7
- Wood Choose from Memo Wood Finishes on page 7

Notes

For step-by-step specifications and quotes, access our live quote tool online at → Quotes

Penna

Small Round Table

Designed by Studio Gorm, 2019

Made in the USA.

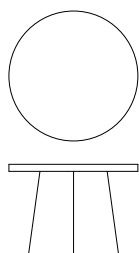

Depth	Width	Height
22.5"	22.5"	16"

Core Product	Core Code	List Price
Small Round Table - Ash	SG01-T3-A	2000
Small Round Table - Walnut	SG01-T3-W	2194

Standard with Core Product

Glides

Forbo Linoleum Top

Solid Wood Edge Band (finish to match base)

Wood Veneer Base

Options

Component	Code	List Price Add
Forbo Linoleum Top	FTT	0
Wood Veneer Top (Ash)	VTA	137
Wood Veneer Top (Walnut)	VTW	181
Ash with Stain Finish	WOA/WBA	80
	WWA	95
	WGA/WNP	110
Power Module (2-power, 2-USB)	PM1	343

Specifiable Finishes

Linoleum Choose from Forbo linoleum products on page 7

Wood Choose from Memo Wood Finishes on page 7

Notes

For step-by-step specifications and quotes, access our live quote tool online at → Quotes

Penna

Bar Table

Designed by Studio Gorm, 2020

Made in the USA.

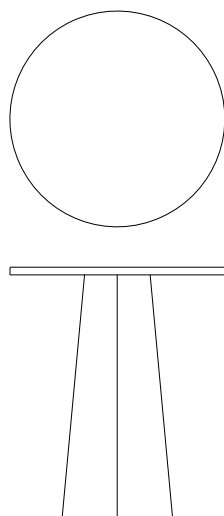

Depth	Width	Height
36"	36"	42"

Core Product	Core Code	List Price
Bar Table - Ash	SG01-T8-36D-A	3709
Bar Table - Walnut	SG01-T8-36D-W	3866

Standard with Core Product

- Glides
- Forbo Linoleum Top
- Solid Wood Edge Band (finish to match base)
- Wood Veneer Base

Options

Component	Code	List Price Add
Forbo Linoleum Top	FTT	0
Wood Veneer Top (Ash)	VTA	214
Wood Veneer Top (Walnut)	VTW	229
Ash with Stain Finish	WOA/WBA	110
	WWA	130
	WGA/WNP	150
Power Module (2-power, 2-USB)	PM1	343

Specifiable Finishes

- Linoleum Choose from Forbo linoleum products on page 7
- Wood Choose from Memo Wood Finishes on page 7

Notes

Bases ship with sandbags in certain models, for ballast

For step-by-step specifications and quotes, access our live quote tool online at → [Quotes](#)

Penna

Café Table

Designed by Studio Gorm, 2020

Made in the USA.

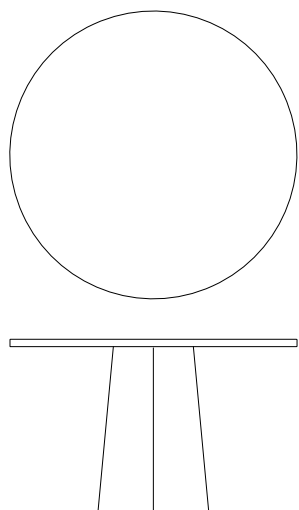

Depth	Width	Height
48"	48"	29"

Core Product	Core Code	List Price
Café Table - Ash	SG01-T6-48D-A	3802
Café Table - Walnut	SG01-T6-48D-W	4031

Standard with Core Product

- Glides
- Forbo Linoleum Top
- Solid Wood Edge Band (finish to match base)
- Wood Veneer Base

Options

Component	Code	List Price Add
Forbo Linoleum Top	FTT	0
Wood Veneer Top (Ash)	VTA	225
Wood Veneer Top (Walnut)	VTW	289
Ash with Stain Finish	WOA/WBA	100
	WWA	120
	WGA/WNP	140
Power Module (2-power, 2-USB)	PM1	343

Specifiable Finishes

- Linoleum Choose from Forbo linoleum products on page 7
- Wood Choose from Memo Wood Finishes on page 7

Notes

Bases ship with sandbags in certain models, for ballast

For step-by-step specifications and quotes, access our live quote tool online at → [Quotes](#)

Penna

Meeting Table

Designed by Studio Gorm, 2020

Made in the USA.

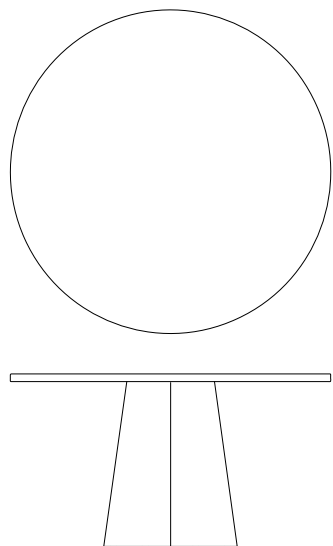

Depth	Width	Height
54"	54"	29"

Core Product	Core Code	List Price
Meeting Table - Ash	SG01-T7-54D-A	3831
Meeting Table - Walnut	SG01-T7-54D-W	4123

Standard with Core Product

- Glides
- Forbo Linoleum Top
- Solid Wood Edge Band (finish to match base)
- Wood Veneer Base

Options

Component	Code	List Price Add
Forbo Linoleum Top	FTT	0
Wood Veneer Top (Ash)	VTA	296
Wood Veneer Top (Walnut)	VTW	354
Ash with Stain Finish	WOA/WBA	100
	WWA	120
	WGA/WNP	140
Power Module (2-power, 2-USB)	PM1	343

Specifiable Finishes

- Linoleum Choose from Forbo linoleum products on page 7
- Wood Choose from Memo Wood Finishes on page 7

Notes

Bases ship with sandbags in certain models, for ballast

For step-by-step specifications and quotes, access our live quote tool online at → [Quotes](#)

Penna

Height Adjustable Café Table
Designed by Studio Gorm, 2020
Made in the USA.

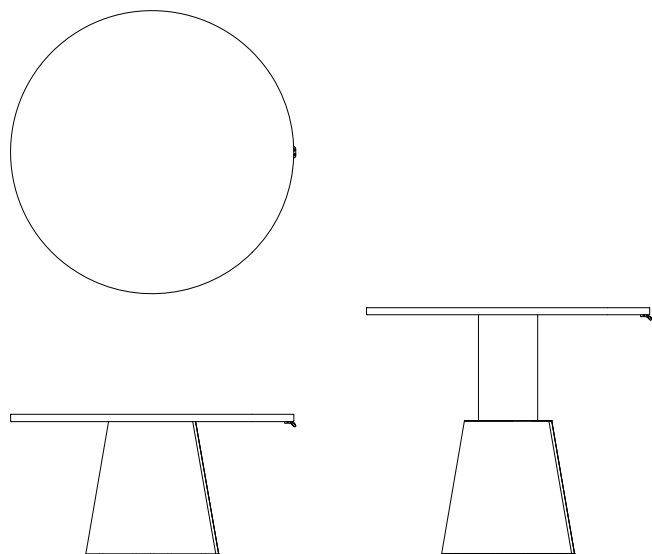

Depth	Width	Height
48"	48"	24" - 42"

Core Product	Core Code	List Price
Café Table - Ash	SG01-T6-HAT-48D-A-MA	7247
Café Table - Walnut	SG01-T6-HAT-48D-W-MA	7517

Standard with Core Product

- Glides
- Forbo Linoleum Top
- Solid Wood Edge Band (finish to match base)
- Wood Veneer Base

Options

Component	Code	List Price Add
Forbo Linoleum Top	FTT	0
Wood Veneer Top (Ash)	VTA	348
Wood Veneer Top (Walnut)	VTW	386
Ash with Stain Finish	WOA/WBA	160
	WWA	180
	WGA/WNP	200
Adjustable Height Column Shroud	PEW/PCY/PFG/POB/PBO/PSG/PDP	0

Specifiable Finishes and Notes overleaf

Specifiable Finishes

Linoleum	Choose from Forbo linoleum products on page 7
Wood	Choose from Memo Wood Finishes on page 7
Painted Wood	PEW/PCY/PFG/POB/PBO/PSG/PDP

Notes

Bases ship with sandbags in certain models, for ballast

For step-by-step specifications and quotes, access our live quote tool online at → [Quotes](#)

Penna

Height Adjustable Meeting Table

Designed by Studio Gorm, 2020

Made in the USA.

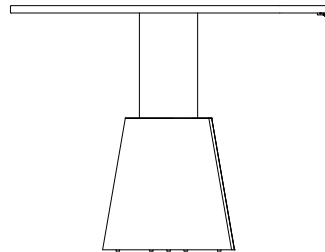
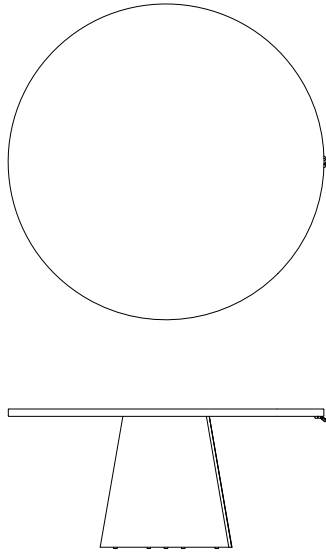

Depth	Width	Height
54"	54"	24" - 42"

Core Product

Meeting Table - Ash
Meeting Table - Walnut

Core Code

SG01-T7-HAT-54D-A-MA
SG01-T7-HAT-54D-W-MA

List Price

7329
7678

Standard with Core Product

- Glides
- Forbo Linoleum Top
- Solid Wood Edge Band (finish to match base)
- Wood Veneer Base

Options

Component	Code	List Price Add
Forbo Linoleum Top	FTT	0
Wood Veneer Top (Ash)	VTA	437
Wood Veneer Top (Walnut)	VTW	451
Ash with Stain Finish	WOA/WBA	160
	WWA	180
	WGA/WNP	200
Adjustable Height Column Shroud	PEW/PCY/PFG/POB/PBO/PSG/PDP	0

Specifiable Finishes and Notes overleaf

Specifiable Finishes

Linoleum	Choose from Forbo linoleum products on page 7
Wood	Choose from Memo Wood Finishes on page 7
Painted Wood	PEW/PCY/PFG/POB/PBO/PSG/PDP

Notes

Bases ship with sandbags in certain models, for ballast

For step-by-step specifications and quotes, access our live quote tool online at → [Quotes](#)

Penna

Height Adjustable Café Table
Designed by Studio Gorm, 2020
Made in the USA.

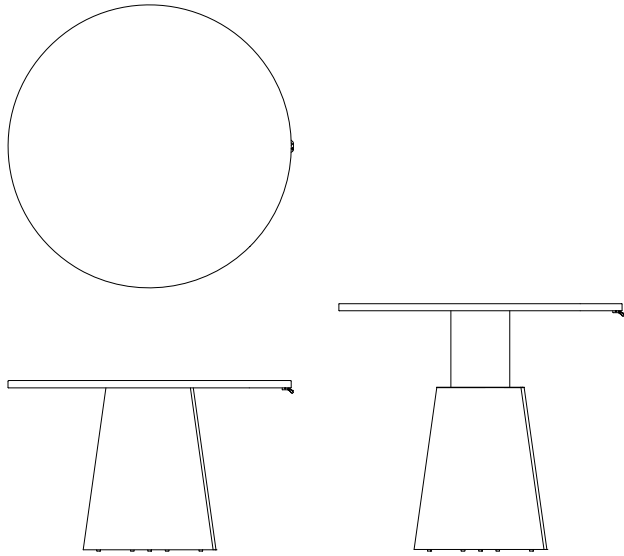

Depth	Width	Height
48"	48"	29" - 42"

Core Product	Core Code	List Price
Café Table - Ash	SG01-T6-HAT-48D-A-MB	7247
Café Table - Walnut	SG01-T6-HAT-48D-W-MB	7517

Standard with Core Product

- Glides
- Forbo Linoleum Top
- Solid Wood Edge Band (finish to match base)
- Wood Veneer Base

Options

Component	Code	List Price Add
Forbo Linoleum Top	FTT	0
Wood Veneer Top (Ash)	VTA	348
Wood Veneer Top (Walnut)	VTW	386
Ash with Stain Finish	WOA/WBA	160
	WWA	180
	WGA/WNP	200
Adjustable Height Column Shroud	PEW/PCY/PFG/POB/PBO/PSG/PDP	0

Specifiable Finishes and Notes overleaf

Specifiable Finishes

Linoleum	Choose from Forbo linoleum products on page 7
Wood	Choose from Memo Wood Finishes on page 7
Painted Wood	PEW/PCY/PFG/POB/PBO/PSG/PDP

Notes

Bases ship with sandbags in certain models, for ballast

For step-by-step specifications and quotes, access our live quote tool online at → [Quotes](#)

Penna

Height Adjustable Meeting Table

Designed by Studio Gorm, 2020

Made in the USA.

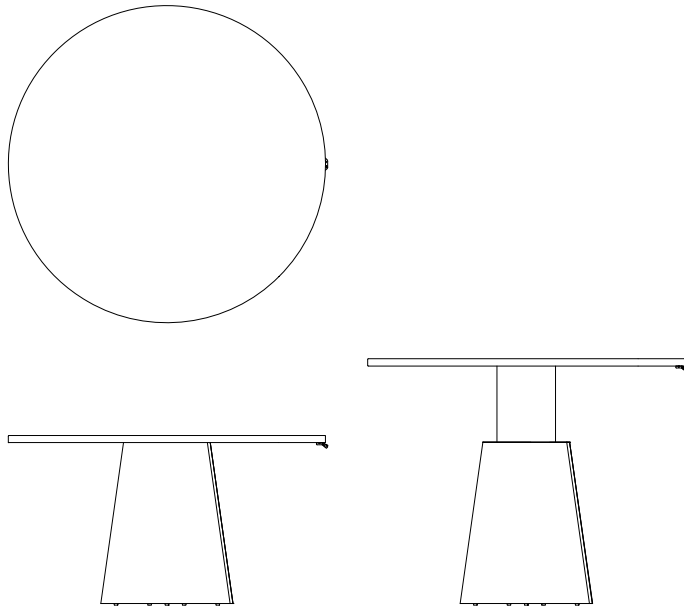

Depth	Width	Height
54"	54"	29" - 42"

Core Product	Core Code	List Price
Meeting Table - Ash	SG01-T7-HAT-54D-A-MB	7329
Meeting Table - Walnut	SG01-T7-HAT-54D-W-MB	7678

Standard with Core Product

- Glides
- Forbo Linoleum Top
- Solid Wood Edge Band (finish to match base)
- Wood Veneer Base

Options

Component	Code	List Price Add
Forbo Linoleum Top	FTT	0
Wood Veneer Top (Ash)	VTA	208
Wood Veneer Top (Walnut)	VTW	437
Ash with Stain Finish	WOA/WBA	160
	WWA	180
	WGA/WNP	200
Adjustable Height Column Shroud	PEW/PCY/PFG/POB/PBO/PSG/PDP	0

Specifiable Finishes and Notes overleaf

Specifiable Finishes

Linoleum	Choose from Forbo linoleum products on page 7
Wood	Choose from Memo Wood Finishes on page 7
Painted Wood	PEW/PCY/PFG/POB/PBO/PSG/PDP

Notes

Bases ship with sandbags in certain models, for ballast

For step-by-step specifications and quotes, access our live quote tool online at → [Quotes](#)

Prose Seating

Side Chair with Arms

Designed by Memo Studio, 2017

Made in the USA.

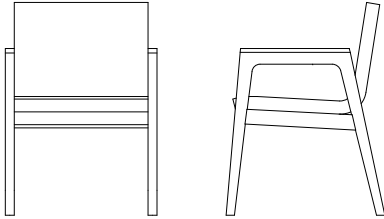

Depth	Width	Height
24"	23"	33"

Core Product

Side Chair with Arms - Ash

Core Code

GC01-10-A

Textile Yardage

Total: 1.50

Seat	Back	Arms
n/a	n/a	n/a

List Price by Textile Grade

	COM / 1	2	3	4	5	6	7	8	9	10	11	12	13	14	15
GC01-10-A	1998	2015	2037	2052	2069	2090	2115	2142	2174	2216	2268	2321	2399	2510	2621

Standard with Core Product

Glides

High Resilience Polyurethane Foam

Solid Wood Arm Caps

Options and Notes overleaf

Options

Component	Code	List Price Add							
Ash with Stain Finish	WOA/WBA	70							
	WWA	140							
	WGA/WNP	210							
Solid Surface Arm Caps	by Grade (right)	CA1	CA2	CA3	CA4	CA5	CA6	CA7	
		277	337	337	474	474	553	553	
Removable Covers	RC	249							
Moisture Barrier	MB	222							

Specifiable Finishes

- Solid Surface Choose from Corian solid surface products on page 82
- Textiles Choose from Camira, Kvadrat, or Maharam textiles on page 80, or contact Memo for assistance with COM fabrics
- Wood Choose from Memo Wood Finishes on page 7

Notes

Due to its continuous seat and back, multiple fabric configurations are not supported on the Prose Side Chair with Arms
For step-by-step specifications and quotes, access our live quote tool online at memofurniture.com/quotes

Prose Seating

Plus Chair

Designed by Memo Studio, 2017

Made in the USA.

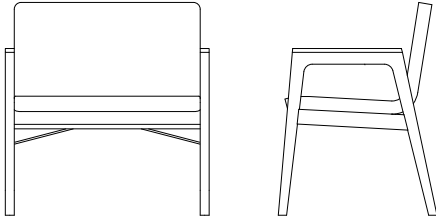

Depth	Width	Height
24"	30.75"	33"

Core Product

Plus Chair - Ash

Core Code

GC01-15-A

Textile Yardage

Total: 2.00

Seat	Back	Arms
n/a	n/a	n/a

List Price by Textile Grade

	COM / 1	2	3	4	5	6	7	8	9	10	11	12	13	14	15
GC01-15-A	2409	2431	2461	2481	2503	2531	2565	2601	2643	2699	2769	2839	2943	3091	3239

Standard with Core Product

Glides

High Resilience Polyurethane Foam

Solid Wood Arm Caps

Options and Notes overleaf

Options

Component	Code	List Price Add							
Ash with Stain Finish	WOA/WBA	70							
	WWA	140							
	WGA/WNP	210							
Solid Surface Arm Caps	by Grade (right)	CA1	CA2	CA3	CA4	CA5	CA6	CA7	
		277	337	337	474	474	553	553	
Removable Covers	RC	179							
Moisture Barrier	MB	222							

Specifiable Finishes

- Solid Surface Choose from Corian solid surface products on page 82
- Textiles Choose from Camira, Kvadrat, or Maharam textiles on page 80, or contact Memo for assistance with COM fabrics
- Wood Choose from Memo Wood Finishes on page 7

Notes

Due to its continuous seat and back, multiple fabric configurations are not supported on the Prose Plus Chair
For step-by-step specifications and quotes, access our live quote tool online at memofurniture.com/quotes

Prose Seating

Settee

Designed by Memo Studio, 2017

Made in the USA.

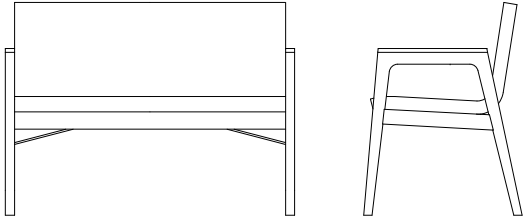

Depth	Width	Height
24"	43.75"	33"

Core Product

Settee - Ash

Core Code

GC01-22-A

Textile Yardage

Total: 2.50

Seat	Back	Arms
n/a	n/a	n/a

List Price by Textile Grade

	COM / 1	2	3	4	5	6	7	8	9	10	11	12	13	14	15
GC01-22-A	3156	3184	3221	3246	3274	3309	3351	3396	3449	3519	3606	3694	3824	4009	4194

Standard with Core Product

Glides

High Resilience Polyurethane Foam

Solid Wood Arm Caps

Options and Notes overleaf

Options

Component	Code	List Price Add							
Ash with Stain Finish	WOA/WBA	88							
	WWA	158							
	WGA/WNP	245							
Solid Surface Arm Caps	by Grade (right)	CA1	CA2	CA3	CA4	CA5	CA6	CA7	
		277	337	337	474	474	553	553	
Removable Covers	RC	297							
Moisture Barrier	MB	244							

Specifiable Finishes

- Solid Surface Choose from Corian solid surface products on page 82
- Textiles Choose from Camira, Kvadrat, or Maharam textiles on page 80, or contact Memo for assistance with COM fabrics
- Wood Choose from Memo Wood Finishes on page 7

Notes

Due to its continuous seat and back, multiple fabric configurations are not supported on the Prose Settee
For step-by-step specifications and quotes, access our live quote tool online at memofurniture.com/quotes

Prose Seating

Lounge

Designed by Memo Studio, 2017

Made in the USA.

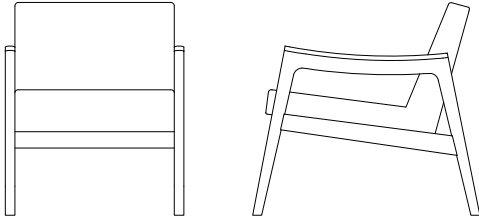

Depth	Width	Height
32"	25.5"	30"

Core Product

Lounge - Ash

Core Code

GC01-01-A

Textile Yardage

Total: 2.00

Seat Back Arms

1.00 1.00 n/a

List Price by Textile Grade

	COM / 1	2	3	4	5	6	7	8	9	10	11	12	13	14	15
GC01-01-A	2772	2794	2824	2844	2866	2894	2928	2964	3006	3062	3132	3202	3306	3454	3602

Standard with Core Product

Glides

High Resilience Polyurethane Foam

Solid Wood Arm Caps

Options and Notes overleaf

Options

Component	Code	List Price Add						
Ash with Stained Finish	WOA/WBA	70						
	WWA	140						
	WGA/WNP	210						
Solid Surface Arm Caps	by Grade (right)	CA1	CA2	CA3	CA4	CA5	CA6	CA7
		291	354	354	499	499	582	582
Removable Covers	RC	279						
Moisture Barrier	MB	222						
Multiple Textiles (Seat/Back)	TA	140						

Specifiable Finishes

- Solid Surface Choose from Corian solid surface products on page 82
- Textiles Choose from Camira, Kvadrat, or Maharam textiles on page 80, or contact Memo for assistance with COM fabrics
- Wood Choose from Memo Wood Finishes on page 7

Notes

Available in custom widths per engineering and quote approval
 Multiple fabric option allows for separate seat and back textiles
 For step-by-step specifications and quotes, access our live quote tool online at memofurniture.com/quotes

Prose Seating

Loveseat

Designed by Memo Studio, 2017

Made in the USA.

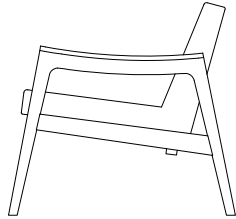
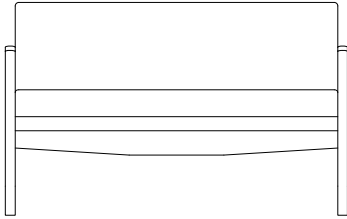

Depth	Width	Height
32"	48"	30"

Core Product

Loveseat - Ash

Core Code

GC01-02-A

Textile Yardage

Total: 4.00

Seat	Back	Arms
2.00	2.00	n/a

List Price by Textile Grade

	COM / 1	2	3	4	5	6	7	8	9	10	11	12	13	14	15
GC01-02-A	3527	3571	3631	3671	3715	3771	3839	3911	3995	4107	4247	4387	4595	4891	5187

Standard with Core Product

Glides

High Resilience Polyurethane Foam

Solid Wood Arm Caps

Options and Notes overleaf

Options

Component	Code	List Price	Add												
Ash with Stain Finish	WOA/WBA	88													
	WWA	158													
	WGA/WNP	245													
Solid Surface Arm Caps	by Grade (right)	CA1	291	CA2	354	CA3	354	CA4	499	CA5	499	CA6	582	CA7	582
Removable Covers	RC	319													
Moisture Barrier	MB	252													
Multiple Textiles (Seat/Back)	TA	140													

Specifiable Finishes

- Solid Surface Choose from Corian solid surface products on page 82
- Textiles Choose from Camira, Kvadrat, or Maharam textiles on page 80, or contact Memo for assistance with COM fabrics
- Wood Choose from Memo Wood Finishes on page 7

Notes

Available in custom widths per engineering and quote approval
 Multiple fabric option allows for separate seat and back textiles
 For step-by-step specifications and quotes, access our live quote tool online at memofurniture.com/quotes

Rolo

Lounge

Designed by Studio Tolvanen, 2021

Made in the USA.

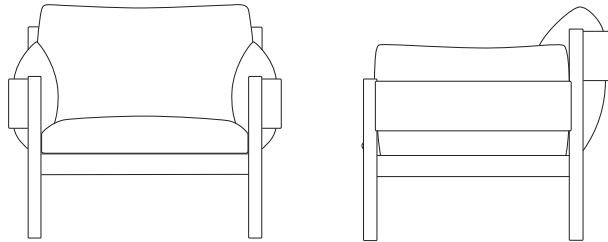

Depth **Width** **Height**
32" 36" 31"

Core Product

Lounge - Ash
Lounge - Walnut

Core Code

ST01-01-A
ST01-01-W

Textile Yardage

Total: 5.25

List Price by Textile Grade*

	COM / 1	2	3	4	5	6	7	8	9	10	11	12	13	14	15
ST01-01-A	4097	4155	4234	4286	4344	4417	4507	4601	4711	4858	5032	5226	5499	5887	6276
ST01-01-W	5234	5292	5371	5423	5481	5554	5644	5738	5848	5995	6169	6363	6636	7024	7413

*Pricing assumes non-railroaded textiles. For railroaded pricing please contact us at info@memofurniture.com

Standard with Core Product

Non-Marring Glides
High Resilience Polyurethane Foam

Options

	Code	List Price Add
Clear Finish (by species)	WCA/WCW	0
Ash with Stain Finish	WOA/WBA	83
	WWA	132
	WGA/WNP	198

Specifiable Finishes

Textiles Choose from Camira, Maharam, or Kvadrat textiles on page 80, or contact Memo for assistance with COM fabrics
Wood Choose from Memo Wood Finishes on page 7

Notes

For step-by-step specifications and quotes, access our live quote tool online at → [Quotes](#)

Rolo

Loveseat

Designed by Studio Tolvanen, 2021

Made in the USA.

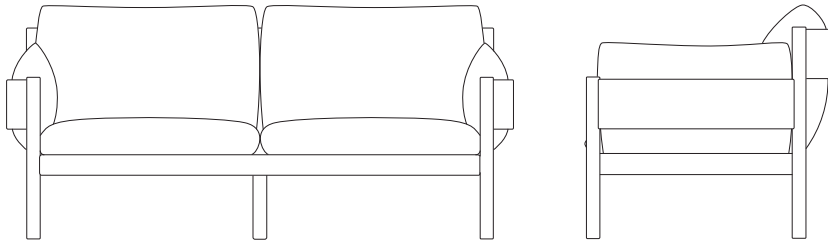

Depth **Width** **Height**
32" 65" 31"

Core Product

Loveseat - Ash
Loveseat - Walnut

Core Code

ST01-02-A
ST01-02-W

Textile Yardage

Total: 8.25

List Price by Textile Grade*

	COM / 1	2	3	4	5	6	7	8	9	10	11	12	13	14	15
ST01-02-A	6141	6232	6356	6438	6529	6644	6785	6933	7106	7337	7610	7915	8344	8954	9565
ST01-02-W	8032	8123	8247	8329	8420	8535	8676	8824	8997	9228	9501	9806	10235	10845	11456

*Pricing assumes non-railroaded textiles. For railroaded pricing please contact us at info@memofurniture.com

Standard with Core Product

Non-Marring Glides
High Resilience Polyurethane Foam

Options

	Code	List Price Add
Clear Finish (by species)	WCA/WCW	0
Ash with Stain Finish	WOA/WBA	96
	WWA	152
	WGA/WNP	231

Specifiable Finishes

Textiles Choose from Camira, Maharam, or Kvadrat textiles on page 80, or contact Memo for assistance with COM fabrics
Wood Choose from Memo Wood Finishes on page 7

Notes

For step-by-step specifications and quotes, access our live quote tool online at → [Quotes](#)

Rolo

Sofa

Designed by Studio Tolvanen, 2021

Made in the USA.

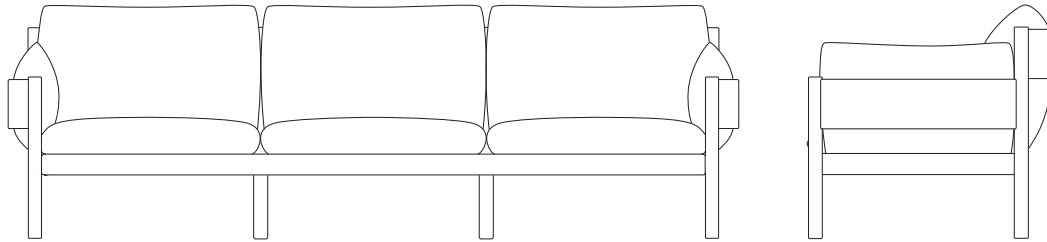

Depth **Width** **Height**
32" 94" 31"

Core Product

Sofa - Ash
Sofa - Walnut

Core Code

ST01-03-A
ST01-03-W

Textile Yardage

Total: 11.5

List Price by Textile Grade*

	COM / 1	2	3	4	5	6	7	8	9	10	11	12	13	14	15
ST01-03-A	8421	8548	8720	8835	8962	9123	9318	9525	9767	10089	10468	10894	11492	12343	13194
ST01-03-W	10640	10767	10939	11054	11181	11342	11537	11744	11986	12308	12687	13113	13711	14562	15413

*Pricing assumes non-railroaded textiles. For railroaded pricing please contact us at info@memofurniture.com

Standard with Core Product

Non-Marring Glides
High Resilience Polyurethane Foam

Options

	Code	List Price Add
Clear Finish (by species)	WCA/WCW	0
Ash with Stain Finish	WOA/WGA	116
	WWA	175
	WGA/WNP	264

Specifiable Finishes

Textiles Choose from Camira, Maharam, or Kvadrat textiles on page 80, or contact Memo for assistance with COM fabrics
Wood Choose from Memo Wood Finishes on page 7

Notes

For step-by-step specifications and quotes, access our live quote tool online at → [Quotes](#)

Rolo

Side Table

Designed by Studio Tolvanen, 2021

Made in the USA.

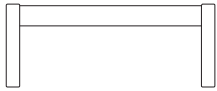
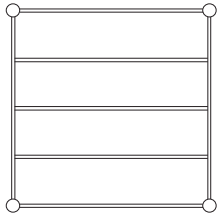

Depth	Width	Height
27.75"	27.75"	11"

Core Product	Core Code	List Price
Side Table - Ash	ST01-T1-A	1249
Side Table - Walnut	ST01-T1-W	1672

Standard with Core Product

Glides

Options

Specifiable Finishes

Choose from Memo Wood Finishes on page 7

	Code	List Price Add
Clear Finish (by species)	WCA/WCW	0
Ash with Stain Finish	WOA/WBA	93
	WWA	147
	WGA/WNP	222

Notes

For step-by-step specifications and quotes, access our live quote tool online at → [Quotes](#)

Rolo

Coffee Table

Designed by Studio Tolvanen, 2021

Made in the USA.

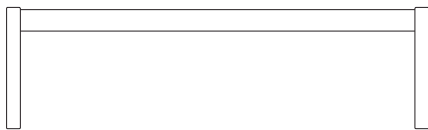
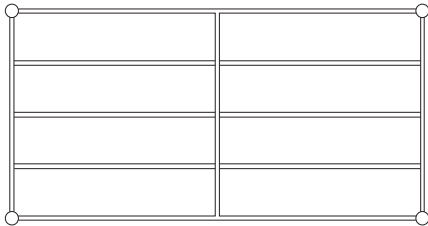

Depth	Width	Height
27.75"	53.75"	15"

Core Product	Core Code	List Price
Coffee Table - Ash	ST01-T2-A	1806
Coffee Table - Walnut	ST01-T2-W	2423

Standard with Core Product

Glides

Options

Specifiable Finishes

Choose from Memo Wood Finishes on page 7

	Code	List Price Add
Clear Finish (by species)	WCA/WCW	0
Ash with Stain Finish	WOA/WBA	112
	WWA	170
	WGA/WNP	256

Notes

For step-by-step specifications and quotes, access our live quote tool online at → [Quotes](#)

Textiles Graded-in sorted by pattern name **Camira**

Pattern Name	Group
Blazer	7
Carragan Flax	10
Era	2
Gravity	2
Main Line Flax	7
Oceanic	6
Quest	3
Rivet	2
Synergy	7

Textiles Graded-in sorted by pattern name **Maharam**

Article	458600	6
Beck	466570	10
Bluff	466489	9
Brindle	466418	8
Campana	466571	12
Chasm	466404	10
Darning Sampler Plaid	466462	15
Felix	466625	12
Firma	466582	11
Flock	901892	8
Frequency	466504	10
Gemma	466568	11
Gemma Multi	466569	11
Isa	466624	12
Jasper	466563	10
Lariat	440401	4
Ledger	463770	9
Manner	466177	5
Mantle	466517	8
Meld	466387	5
Merit	458600	6
Messenger	458640	5
Metaphor	466553	5
Metric	466014	5
Method	466579	5
Mode	466337	6
Murmur	466446	5
Muse	466487	4
Nico	466564	8
Pare	466359	11

Textiles Graded-in sorted by pattern name **Kvadrat**

Pattern Name	Group
Arda (Febrik)	13
Canvas 2	10
Coda 2	14
Divina MD	11
Divina Melange 3	11
Fiord 2	12
Hallingdal 65	12
Harald 3	13
Melange Nap	11
Remix 3	9
Re-Wool	10
Steelcut 2	11
Steelcut Trio 3	11
Tonica 2	10

Textiles Graded-in sorted by Grading Group: **Camira**

Group & Price/yard	Pattern Name
Group 1 48	
Group 2 59	Era
	Gravity
	Rivet
Group 3 74	Quest
Group 4 84	
Group 5 95	
Group 6 109	Oceanic
Group 7 126	Blazer
	Main Line Flax
	Synergy
Group 8 144	
Group 9 165	
Group 10 193	Craggan Flax

Textiles Graded-in sorted by Grading Group: **Kvadrat**

Group & Price/yard	Pattern Name
Group 1 48	
Group 2 59	
Group 3 74	
Group 4 84	
Group 5 95	
Group 6 109	
Group 7 126	
Group 8 144	
Group 9 165	Remix 3
Group 10 193	Canvas 2
	Re-wool
	Tonica 2
Group 11 228	Divina MD
	Divina Melange 3
	Melange Nap
	Steelcut 2
	Steelcut Trio 3
Group 12 263	Fiord 2
	Hallingdal 65
Group 13 315	Arda (Febrik)
	Harald 3
Group 14 389	Coda 2

Textiles Graded-in sorted by Grading Group: **Maharam**

Group & Price/yard	Pattern Name	Number
Group 1 48		
Group 2 59		
Group 3 74		
Group 4 84	Lariat	440401
	Muse	466487
Group 5 95	Manner	466177
	Meld	466387
	Messenger	458640
	Metaphor	466553
	Method	466579
	Metric	466014
	Murmur	466446
Group 6 109	Article	458600
	Merit	458600
	Mode	466337
Group 7 126		
Group 8 144	Brindle	466418
	Flock	901892
	Mantle	466517
	Nico	466564
Group 9 165	Bluff	466489
	Ledger	463770
Group 10 193	Beck	466570
	Chasm	466404
	Frequency	466504
	Jasper	466563
Group 11 228	Firma	466582
	Gemma	466568
	Gemma Multi	466569
	Pare	466359
Group 12 263	Campana	466571
	Felix	466625
	Isa	466624
Group 13		
Group 14 389	Darning Sampler Plaid	466462

Corian Solid Surface Schedule sorted by Grading Group

Group 1	Abalone Bisque Bone Cameo White Glacier White Linen Maui Sahara Sandstone Silver Gray Vanilla	Group 4	Deep Caviar Deep Mink Deep Night Sky Dove Flint Fossil Granola Pine Raffia Rice Paper Royal Red Seafoam Serene Sage Suede Venaro White Whisper White Jasmine	Group 5	Whipped Cream Willow	Group 7	Minera Nimbus Prima Sagebrush Sand Storm Smoke Drift Prima Sonora Stardust White Onyx Windswept Prima
Group 2	Antarctica Aurora Blue Pebble Canyon Cocoa Brown Designer White Modern White Mojave Sand Savannah Stratus Summit White	Group 5	Anthracite Ash Concrete Blue Spice Carbon Concrete Cilantro Deep Anthracite Deep Bedrock Deep Cloud Deep Espresso Deep Nocturne Deep Sable Deep Space Deep Storm Deep Titanium Doeskin Fawn Glacier Ice Matterhorn Neutral Concrete Oat Silver Birch Silverite Weathered Concrete	Group 6	Arrowroot Basil Clam Shell Cool Gray Cosmos Prima Earth Gray Onyx Hazelnut Jasmine Keystone Lava Rock Limev Prima Natural Gray Rain Cloud Riverbed Rosemary Saffron Sandalwood Sorrel Tumbleweed Witch Hazel		
Group 3	Elegant Gray Everest Moss Nightfall Pearl Gray Platinum Silt Sparkling White			Group 7	Allspice Aqualite Burlled Beach Cocoa Prima Deep Inkwell Deep Lapis Deep Smoky Pear Deep Terrain Dune Prima Ecru Elderberry Evening Prima Graylite Hickory Smoke Juniper Milky Way		
Group 4	Arctic Ice Bronzite Canvas Cobalt Concrete Cottage Lane Deep Black Quartz						