

Pricelist
2025 / Q2

memo

Contents

page 3 Terms of Sale
page 4 Limited Lifetime Warranty
page 5 Customer Service
page 6 Finishes Overview
page 8 Textiles Overview

page 12 April Seating
page 12 Side Chair
page 13 ADA Stool
page 14 Counter Stool
page 15 Bar Stool
page 16 Bar Stool w/ Low Back

page 17 B-Side Tables
page 17 Personal Table
page 19 Side Table
page 21 Coffee Table

page 23 Chord Tables
page 23 Personal Table
page 25 Side Table
page 27 Coffee Table

page 29 Chroma Seating
page 29 Lounge
page 30 Lounge Armless
page 31 Lounge Swivel
page 32 Ottoman - 17
page 33 Ottoman - 24
page 34 Ottoman - 29
page 35 Ottoman - 38

page 36 Ida
page 36 Ida

page 37 Kino
page 37 Kino

page 39 Maru Benches
page 39 Three Slat Bench, 3/4 Length
page 41 Three Slat Bench
page 43 Five Slat Bench
page 46 Seven Slat Bench

page 49 Orca Screens
page 49 Vertical Screen
page 51 Horizontal Screen

page 53 Penna Seating
page 53 Penna Lounge

page 54 Penna Tables
page 54 Large Round
page 55 Obround
page 56 Small Round
page 57 Bar Table
page 59 Café Table

page 61 Meeting Table
page 63 Height Adjustable Cafe table 24-42, 48 diameter
page 65 Height Adjustable Meeting table 24-42, 54 diameter
page 67 Height Adjustable Cafe table 29-42, 48 diameter
page 70 Height Adjustable Meeting table 24-42, 54 diameter

page 71 Prose Seating
page 71 Side Chair with Arms
page 73 Plus Chair
page 75 Settee
page 77 Lounge
page 80 Loveseat

page 81 Rolo Seating
page 81 Lounge
page 83 Loveseat
page 84 Sofa

page 84 Rolo Tables
page 84 Side Table
page 85 Coffee Table

page 86 Materials & Finishes Schedules
page 86 Textiles Schedule
page 88 Corian Solid Surface Schedule

Terms of Sale

Pricing Policy

All prices shown for products and accessories are manufacturer's suggested list price. Prices shown do not include freight, surcharges, appropriate taxes, crating (if applicable), storage, or installation charges. Memo reserves the right to amend price lists, change designs, and discontinue or add models without prior notice. Price list of latest date supersedes and cancels all previous lists. All orders accepted are subject to prices upon receipt of order.

Payment Terms

Except as otherwise specified, all orders require a 50% deposit with the balance due with thirty (30) days from the invoice date. All payments are payable in U.S. dollars. Lead times start after the receipt of deposit. Payments not made by the due date may incur, at the sole discretion of Memo, a late payment service charge of 1.5% per month. All payments and deposits are non-refundable.

Changes and Cancellations

Customers will receive a written confirmation of pricing, credit terms and estimated completion date. Changes to orders or cancellations made after production has begun will carry extra charges based on expenses incurred.

Shipping

Standard cartoning and standard surface freight to any point within the 48 contiguous United States is included in Memo quotes as a separate charge independent of product price. For shipments to Alaska, Hawaii and International destinations, additional shipping and handling charges will apply. Orders are shipped cartoned as standard. If crating is requested or required, additional charges will apply and a custom quote will be provided. Service add-ons for freight will also include additional charges as follows:

Gate Lift : \$125 NET

Residential Delivery : \$150 NET

Delivery Appointment in Advance: \$100 NET

Any additional freight charges will be provided at the time of quote. From time to time, market conditions for fuel and/or labor may result in freight surcharges, beyond our standard rates. In these cases, surcharges will be indicated on all quotes.

Freight Claims

Product is shipped FOB Factory, freight prepaid and allowed via truck. The title of goods changes to the purchaser when merchandise leaves Memo's dock. All shipments are transferred to the transportation company in good condition.

Receiver and/or specifier are required to inspect cartons and product upon receipt and note the condition and any damage or shortage on the Bill of Lading upon delivery. Receiver and or specifier are required to notify Memo and the carrier of evident damage or product shortages at time of delivery and request an inspection. Failure to report evident damage or product shortages within (3) business days of delivery will be considered total and full acceptance of goods as is. In the case of shipping damage, the receiver and/or specifier is to provide Memo with photographs of the damaged carton/packaging and goods. Photographs are required for Memo to process and award if approved, any claims for recovery. Shipping cartons and packaging should be retained for carrier inspection and the damaged product should be kept in the receiving location. If the freight carrier will not perform the inspection, receiver and/or specifier should prepare an affidavit; noting that the freight company refused to comply with an inspection - citing date and time.

Any concealed damage claims against Memo for apparent damages must be made by the purchaser and or specifier in writing within five (5) business days of delivery, including a copy of the BOL and photographs of the carton/ packaging and damaged goods. Failure to notify Memo within 5 business days of receipt shall constitute acceptance of the product and waiver of any apparent damages resulting in replacement and or repair of damaged goods being billed to the purchaser.

Any relevant damage or shortages to blanket wrapped shipments must be noted on the Bill of Lading at the time of delivery.

Custom Requests

Requests to modify existing products (Modifications) or to produce ground-up solutions (Specials) should be submitted to our customer service group, at which time they will be assessed and submitted for design and engineering approval. All custom requests will elicit a receipt and a response will be provided within 48 hours of receipt. Upon approval, a price and lead-time quote will be generated and provided for customer review and acceptance.

10 Year Warranty

Memo Furniture warrants its products, to the original user and for the original purpose, to be free of defects in design, material and workmanship, given normal use and care for a period of ten (10) years, from date of delivery. This warranty does not include damage from accident, alteration, misuse, normal wear and tear, transportation or improper installation and maintenance.

During the warranty period, Memo Furniture, at its option, will repair or replace any product which, upon inspection by Memo Furniture or its designated representative, is deemed to be defective in materials or workmanship and is covered by this warranty.

This warranty does not apply to defects, wear, or failures, in components not manufactured by Memo Furniture, including but not limited to textiles, leathers, casters, and electronic components. In these cases, the warranty period provided by the supplier of the component will apply. The liability of Memo Furniture is limited to furnishing new parts as may be necessary to replace any item that may prove to be defective in material or workmanship. Memo Furniture will make every effort to replace parts if they are available from the supplier of those parts. We will not assume liability for charges for labor, consequential expenses or damages incurred.

Approvals by Memo to use COM or COL textiles refer to our ability to apply and execute said material on our products only and do not include durability, cleanability, suitability, and wear. Appropriate specification of any textile or leather is the sole responsibility of the specifier.

Normal aging and wear of any COM, COL, or Graded In, woven and non-woven upholstery are exempt from this warranty. Please check with the textile manufacturer for their warranty and appropriate cleaning instructions.

Due to natural variations, in which Memo Furniture has no control, this warranty does not extend to color, grain, texture or the durability or suitability of any exterior surface coatings or treatments.

In addition to our standard furniture offering, Memo Furniture also manufactures Custom Product Solutions for specific needs. Custom Product Solutions are warranted for a period of one (1) year against defects in materials and workmanship.

This warranty is void in cases of damage in transit, negligence, abuse, abnormal usage, misuse, accidents, and improper cleaning and maintenance.

All other warranties, expressed or implied, are excluded. Memo Furniture shall not be liable for incidental or consequential damages of any sort.

Memo is committed to the complete satisfaction of our customers with our products and performance. If a problem arises with a Memo product after the expiration of the warranty period, Memo will exercise its best efforts to achieve your resolution in a manner that is fair to all concerned.

If you have any questions or wish to file a claim against this warranty, please contact us at: service@memofurniture.com

Customer Service

Memo's Customer Service Group is trained to assist with quotes, orders, custom requests, product details, warranty inquiries, and to answer general questions.

We can be reached Monday through Friday, 8:00 am – 5:00 pm Pacific Time, directly via email at service@memofurniture.com

Inquiries received after-hours via voicemail or email will receive a response before the close of business on the following business day.

Please visit www.memofurniture.com for answers to most questions including product prices, specifications, photos, SketchUp and Revit files, and marketing material.

Please visit our quote tool <https://staging-quotes.memofurniture.com> for 24/7 live access to quotes and our configurator. Additionally, a local sales representative can assist you further. Contact names and numbers are also available on our website.

Finishes

Memo offers a range of proprietary colors and finishes on select materials, as well as support for a broad range of open line laminates and solid surface. Our finishes have been curated to offer a foundation of essential base neutrals, to which accents and stronger colors can be added.

Memo offers finish and pattern selections in the following materials:

Forbo Furniture Linoleum

Memo offers Forbo furniture-grade linoleum on select products. Forbo is a durable surface material, available in a dynamic range of colors. Derived from solidified Linseed Oil and other natural fillers such as cork and wood dust, Forbo is a sustainable and resilient surface choice.

Metal Powder Coat

Our powder coats are applied to both steel and aluminum, and are available in textured and smooth finishes. Powder coating is extremely durable and emits zero pollutants once cured.

Natural Stone

Memo offers natural stone on select table and horizontal surface tops. Our stone is hand selected from the highest quality slabs however natural variances will occur from product to product.

Solid Surface

Memo offers Natural Cork and Wilsonart solid surface options on certain products. Solid Surface is a non-porous high durability product that is stain resistant, easy to clean, and easily repairable. Natural Cork is a lightweight and sustainable material known for its durability and natural insulation.

Wood & Veneer

Our products utilize both solid wood and wood veneer, and are offered in either Ash, Beech or Walnut depending on the product. Products with edge profiles will include a matching wood edge. Wood products are finished in a resilient, long lasting, conversion varnish.

Memo Colors and Finishes

Metal Powder Coat

Steel Gray Gloss	MSG
Med Bronze Gloss	MMB
Black Texture	MBT
Silver Metallic Gloss	MSM
Yellow Leaf Gloss	MYL
Copper Red Matte	MCR
Sage Green Matte	MGG
Navy Blue Matte	MNB

Natural Stone

White Gray Marble	RWM
-------------------	-----

Solid Surface (Wilsonart)

Black Onyx Mirage	STS-BLS
Hidden Spaces	STS-HIS
Kimberlite	STS-KIS
Yukon Riverstone	STS-YUS

Wood & Veneer

Clear Over Ash	WCA
Oak Over Ash	WOA
Gray Over Ash	WGA
Walnut Over Ash	WWA
Navy Over Ash	WBA
Black Over Ash	WBA
Clear Over Beech	WCB
Oak Over Beech	WOB
Gray Over Beech	WGB
Walnut Over Beech	WWB
Black Over Beech	WBB
Clear Over Walnut	WCW

Painted Wood

Blood Orange	PBO
Cashew Yellow	PCY
Cream White	PCW
Dusty Pink	PDP
Forest Green	PFG
Ocean Blue	POB
Stone Gray	PSG

Forbo Furniture Linoleum

Ash - 4132	FAS
Burgundy - 4154	FBU
Iron - 4178	FIR
Pebble - 4175	FPE
Pewter - 4155	FPW
Powder - 4185	FPO
Smokey Blue - 4179	FSB

Cork

Natural	CNC
Dark Chocolate	CDK

Really by Kadrat

Cotton White	RCW
Blue Denim	RBD

Textiles

Graded-in Textiles

Memo has partnered with Camira, Designtex, Kvadrat, and Maharam to offer graded-in textiles. All graded-in textiles are listed by Pattern Name on page 77 and by Grading Group on page 78. Our Grading Groups and their LIST prices per yard are outlined below. Published product prices, including the cost of Graded-in Textiles, have been calculated by multiplying by the price per yard figures below by the yardage requirements indicated on a given product page.

Grading Group	LIST Price per Yard
1	53
2	64
3	75
4	84
5	95
6	109
7	126
8	144
9	165
10	193
11	228
12	263
13	315
14	389
15	463

Memo is glad to grade in textiles from suppliers other than Camira, Designtex, Kvadrat, and Maharam per customer requests. A grading fee of \$200 NET per pattern, per product, will apply in such cases. Please contact us to submit grading requests.

When specifying graded-in textiles the projected completion date of your order may exceed our normal lead times due to constraints of the textile supplier. In such instances, Memo will promptly communicate such delays and advise on adjusted lead times.

Textiles are subject to the quality and shipping standards of the provider. Memo assumes no responsibility for defects, color inaccuracies, shortages, wear, or performance of textiles.

Ordering a Textile Sample

Samples can be ordered by visiting the textile provider's website.

Textiles

Customer's Own Material (COM)

While we recommend selecting from our graded-in partners for the most streamlined process, we also provide the option to use COM. Memo, however, reserves the right to reject textiles which are unsuitable for upholstery on our products. This may be due to inadequate textile weight or unique elastic qualities which impact the integrity of upholstery on our products.

To select fabric outside of the graded-in fabric program, a few steps are required. Memo provides the total yardage for each product on its product spec sheets and pricelist reference pages. These published yardage figures are based on the application conditions of the cutting pattern for each product as well as managing quality issues. Certain textiles, depending on their width and/or repeat, may require additional yardage beyond the figures in our pricing pages. To calculate additional yardage, see our guidelines on page 11. Memo will also provide yardage requirements upon receipt of an order.

Upon receipt of the textile, Memo will immediately advise if flaws or deficiencies in the order are discovered. Memo assumes no responsibility for defects, color inaccuracies, shortages, wear, or sub-standard performance of the specified textiles.

Note that Memo will dispose of excess upholstery material at the time of shipment unless expressly requested to return it with the product shipment.

Customer's Own Leather (COL)

Please contact our customer service group at info@memofurniture.com

Textiles

Delivery of Customer's Own Material (COM)

Customers are responsible for ensuring delivery of COM fabric to Memo. Orders for COM-upholstered products will be scheduled into production upon receipt of all COM and swatches. Please work with our customer service group to procure written confirmation of textile supplier ship dates to ensure the best possible lead time. Since shipment of COM orders depends upon textile availability, lead times may vary.

When supplying COM textiles to Memo, please include the following info:

Textile supplier

Pattern name and number

Color name and number

A representative fabric swatch for identification purposes with face side marked

Any nonstandard treatments applied to the fabric

Any additional documentation

All COM or COL must be sent prepaid to the following address and tagged as follows:

Kaas Tailored c/o Memo Furniture

13000 Beverly Park Road, Suite A

Mukilteo, WA 98275

Attn: Receiving Department

Dealer name

P.O. #

Order code # (for each fabric)

Textiles

Order Requirements for Customer's Own Material (COM)

Memo reserves the right to reject textiles or materials. Textiles requiring secondary backing or coatings should be treated prior to shipping to Memo. All yardage figures listed in Memo product spec sheets and pricelist reference pages are based on at least 54" Wide, Plain Fabric, Standard Cut.

Increases for Textile Width and/or Repeat

In the event that COM textile is both less than 54" wide and also has a repeat, add both of the two increases shown below. For textiles that require matching (stripes, plaids, prints, pattern repeats) it is Memo's policy to match all pattern repeats, stripes, prints or plaids unless specified 'No Matching Required' on purchase order.

Fabric Bolts Less than 54" Wide

Less than 54" wide	Add 08%
Less than 50" wide	Add 13%
Less than 48" wide	Add 20%
Less than 45" wide	Add 50%
Less than 36" wide	Add 60%

Fabrics with Repeats

Repeat 7" & less	Add 11%
Repeat 13" & less	Add 18%
Repeat 21" & less	Add 21%
Repeat 27" & less	Add 24%
Repeat more than 27"	Add 25%

Order Requirements for Customer's Own Leather (COL)

COL orders are based on an average hide size of 45 square feet of usable leather and 19 feet per yard. Due to shape and quality issues with some leather, additional hides may be required after receipt of COL. Ship full hides only.

To convert COM yardage requirements to COL square footage and number of hides, multiply the COM yardage by 19.

Example: 5 yards x 19 = 95 square feet.

April

Side Chair

Designed by Jun Yasumoto, 2022

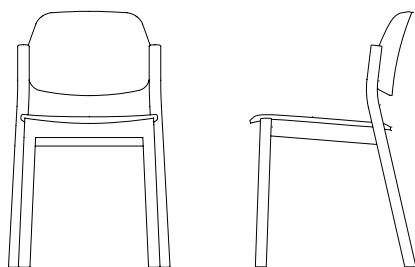

Depth	Width	Height
19.5	19.25	30.75

Core Product	Core Code	List Price
Side Chair - Beech	JY02-10	894

Standard with Core Product

Non-marring Glides

Textile Yardage	Seat
Total: .65	.65

List Price by Textile Grade*

	COM / 1	2	3	4	5	6	7	8	9	10	11	12	13	14	15
JY02-10-UPH	1285	1293	1300	1306	1313	1322	1333	1345	1358	1376	1399	1422	1456	1504	1552

Options	Code	List Price Add
Upholstered Seat	UPH	See above
Clear Over Beech	WCB	0
Stain Finishes	WGB/WOB/WWB/WBB/WBA	73
Painted Wood	PEW/PCY/PFG/POB/PBO/PSG/PDP	105

Notes

For step-by-step specifications and quotes, access our live quote tool on our website.

April
ADA Stool
Designed by Jun Yasumoto, 2022

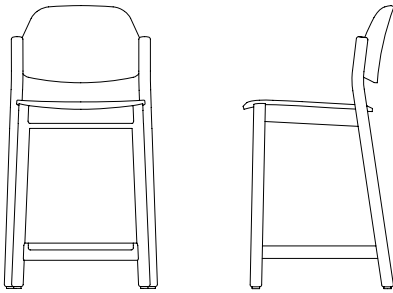

Depth	Width	Height
18	18.5	34

Core Product	Core Code	List Price
ADA Height Stool - Beech	JY02-15	995

Standard with Core Product
Glides
Stainless Steel Footrail

Textile Yardage	Seat
Total: .65	.65

List Price by Textile Grade*

	COM / 1	2	3	4	5	6	7	8	9	10	11	12	13	14	15
JY02-15-UPH	1293	1300	1310	1317	1324	1333	1344	1356	1369	1387	1409	1433	1467	1515	1563

Options	Code	List Price Add
Upholstered Seat	UPH	See above
Clear Over Beech	WCB	0
Stain Finishes	WGB/WOB/WWB/WBB/WBA	83
Painted Wood	PEW/PCY/PFG/POB/PBO/PSG/PDP	113

Notes
For step-by-step specifications and quotes, access our live quote tool on our website.

April
Counter Stool
Designed by Jun Yasumoto, 2022

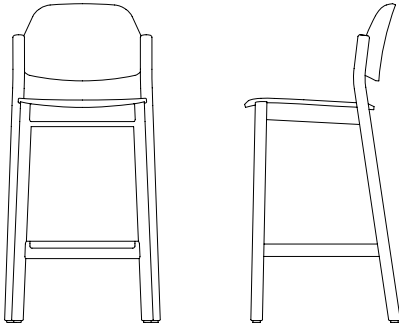

Depth	Width	Height
18	18.5	38

Core Product	Core Code	List Price
Counter Stool - Beech	JY02-16	995

Standard with Core Product
Glides
Stainless Steel Footrail

Textile Yardage	Seat
Total: .65	.65

List Price by Textile Grade*

	COM / 1	2	3	4	5	6	7	8	9	10	11	12	13	14	15
JY02-16-UPH	1461	1468	1475	1481	1488	1497	1508	1520	1533	1552	1574	1597	1631	1679	1727

Options	Code	List Price Add
Upholstered Seat	UPH	See above
Clear Over Beech	WCB	0
Stain Finishes	WGB/WOB/WWB/WBB/WBA	83
Painted Wood	PEW/PCY/PFG/POB/PBO/PSG/PDP	115

Notes
For step-by-step specifications and quotes, access our live quote tool on our website.

April

Bar Stool

Designed by Jun Yasumoto, 2022

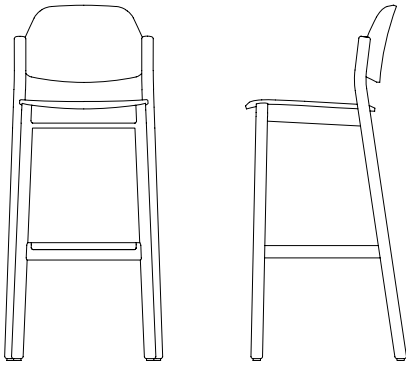

Depth	Width	Height
18	18.75	42.25

Core Product	Core Code	List Price
Bar Stool - Beech	JY02-17	1005

Standard with Core Product
Glides
Stainless Steel Footrail

Textile Yardage	Seat
Total: .65	.65

List Price by Textile Grade*

	COM / 1	2	3	4	5	6	7	8	9	10	11	12	13	14	15
JY02-17-UPH	1487	1494	1501	1507	1514	1523	1534	1546	1560	1578	1601	1623	1657	1705	1753

Options	Code	List Price Add
Upholstered Seat	UPH	See above
Clear over Beech	WCB	0
Stain Finishes	WGB/WOB/WWB/WBB/WBA	83
Painted Wood	PEW/PCY/PFG/POB/PBO/PSG/PDP	115

Notes

For step-by-step specifications and quotes, access our live quote tool on our website.

B-Side

Personal Table

Designed by Standard Issue, 2024

Made in the USA.

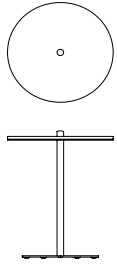

Depth	Width	Height
18"	18"	22"

Core Product	Core Code	List Price
Personal Table	MM03-T1	753

Standard with Core Product

Two Sided Top

Powder Coated Steel and Aluminum Frame

Non-marring glides

Options

	Code	List Price Add
Top Options		
Forbo Linoleum	FTT	525
Wood Veneer (Ash)	VTA	
Clear Finish	WCA/WCW	613
Stain Finish	WOA/WWA/WGA/WNP/WBA	651
Wood Veneer (Walnut)	VTW	648
Solid Surface		
Yukon Riverstone	STS-YUS	613
Black Onyx Mirage	STS-BLS	613
Hidden Space	STS-HIS	613
Kimberlite	STS-KIS	700
Cork		
	CTT-CNC	910
	CTT-CDK	910
Laminate		
	LTT-LTF	525
Formica	LTT-LTP	525
Panolam	LTT-LTW	525
Wilsonart	LTT-LTA	525
Abet Laminate	RTT-RCW	945
	RTT-RBD	945

Specifiable Finishes

- Linoleum Choose from Forbo linoleum products on page 7
- Metal Choose from Memo Metal Powder Coat Finishes on page 7
- Wood Choose from Memo Wood Finishes on page 7
- Solid Surface Choose from Memo Solid Surface Finishes on page 7
- Cork Choose from Memo Cork Finishes on page 7
- Laminate Choose from Open Line Laminates
- Really Choose from Memo Really Finishes on page 7

Notes

For step-by-step specifications and quotes, access our live quote tool on our website.

B-Side
End Table
Designed by Standard Issue, 2024
Made in the USA.

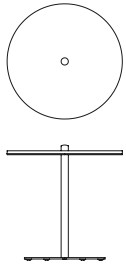

Depth	Width	Height
20"	20"	19"

Core Product	Core Code	List Price
End Table	MM03-T2	798

Standard with Core Product
Two Sided Top
Powder Coated Steel and Aluminum Frame
Non-marring glides

Options		Code	List Price Add
Top Options			
Forbo Linoleum		FTT	578
Wood Veneer (Ash)		VTA	
Clear Finish		WCA/WCW	700
Stain Finish		WOA/WWA/WGA/WNP/WBA	757
Wood Veneer (Walnut)		VTW	753
Solid Surface			
Yukon Riverstone		STS-YUS	700
Black Onyx Mirage		STS-BLS	700
Hidden Space		STS-HIS	700
Kimberlite		STS-KIS	805
Cork		CTT-CNC	945
		CTT-CDK	945
Laminate		LTT-LTF	578
		LTT-LTP	578
		LTT-LTW	578
		LTT-LTA	578
Really		RTT-RCW	980
		RTT-RBD	980

Specifiable Finishes

- Linoleum Choose from Forbo linoleum products on page 7
- Metal Choose from Memo Metal Powder Coat Finishes on page 7
- Wood Choose from Memo Wood Finishes on page 7
- Solid Surface Choose from Memo Solid Surface Finishes on page 7
- Cork Choose from Memo Cork Finishes on page 7
- Laminate Choose from Open Line Laminates
- Really Choose from Memo Really Finishes on page 7

Notes

For step-by-step specifications and quotes, access our live quote tool on our website.

B-Side

Coffee Table

Designed by Standard Issue, 2024

Made in the USA.

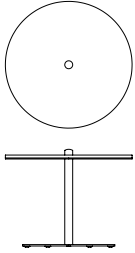

Depth	Width	Height
22"	22"	16"

Core Product	Core Code	List Price
Coffee Table	MM03-T3	865

Standard with Core Product

Two Sided Top

Powder Coated Steel and Aluminum Frame

Non-marring glides

Options

	Code	List Price Add
Top Options		
Forbo Linoleum	FTT	630
Wood Veneer (Ash)	VTA	
Clear Finish	WCA/WCW	788
Stain Finish	WOA/WWA/WGA/WNP/WBA	864
Wood Veneer (Walnut)	VTW	875
Solid Surface		
Yukon Riverstone	STS-YUS	788
Black Onyx Mirage	STS-BLS	788
Hidden Space	STS-HIS	788
Kimberlite	STS-KIS	980
Cork		
	CTT-CNC	980
	CTT-CDK	980
Laminate		
	LTT-LTF	630
	LTT-LTP	630
	LTT-LTW	630
	LTT-LTA	630
Really		
	RTT-RCW	1015
	RTT-RBD	1015

Specifiable Finishes

- Linoleum Choose from Forbo linoleum products on page 7
- Metal Choose from Memo Metal Powder Coat Finishes on page 7
- Wood Choose from Memo Wood Finishes on page 7
- Solid Surface Choose from Memo Solid Surface Finishes on page 7
- Cork Choose from Memo Cork Finishes on page 7
- Laminate Choose from Open Line Laminates
- Really Choose from Memo Really Finishes on page 7

Notes

For step-by-step specifications and quotes, access our live quote tool on our website.

Chord

Personal Table

Designed by Standard Issue, 2019

Made in the USA.

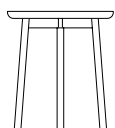
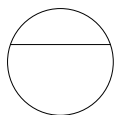

Depth	Width	Height
18"	18"	20.5"

Core Product	Core Code	List Price
Personal Table	MM01-T1	1136

Standard with Core Product

Glides

Open Tray Surface

Powder Coated Steel Frame

Options

	Code	List Price Add
Large Insert Options		
Forbo Linoleum	FTL	301
Wood Veneer (Ash)	VAL	384
Clear Finish	WCA/WCW	0
Stain Finish	WOA/WWA/WGA/WNP/WBA	38
Wood Veneer (Walnut)	VWL	438
Small Insert Options		
No Insert (void)	XXS	0
Forbo Linoleum	FTS	9
Wood Veneer (Ash)	VAS	36
Clear Finish	WCA/WCW	0
Stain Finish	WOA/WWA/WGA/WNP/WBA	38
Wood Veneer (Walnut)	VWS	59
Solid Surface		
Yukon Riverstone	STS-YUS	351
Black Onyx Mirage	STS-BLS	351
Hidden Space	STS-HIS	351
Kimberlite	STS-KIS	452

Specifiable Finishes

- Linoleum** Choose from Forbo linoleum products on page 7
- Metal** Choose from Memo Metal Powder Coat Finishes on page 7
- Wood** Choose from Memo Wood Finishes on page 7
- Solid Surface** Choose from Memo Solid Surface Finishes on page 7

Notes

For step-by-step specifications and quotes, access our live quote tool on our website.

Chord

Side Table

Designed by Standard Issue, 2019

Made in the USA.

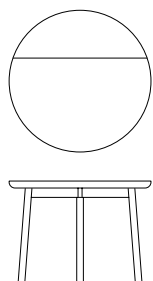

Depth	Width	Height
24"	24"	17.25"

Core Product	Core Code	List Price
Side Table	MM01-T2	1290

Standard with Core Product

Glides

Open Tray Surface

Powder Coated Steel Frame

Options

	Code	List Price Add
Large Insert Options		
Forbo Linoleum	FTL	367
Wood Veneer (Ash)	VAL	530
Clear Finish	WCA/WCW	0
Stain Finish	WOA/WWA/WGA/WNP/WBA	57
Wood Veneer (Walnut)	VWL	620
Small Insert Options		
No Insert (void)	XXS	0
Forbo Linoleum	FTS	17
Wood Veneer (Ash)	VAS	38
Clear Finish	WCA/WCW	0
Stain Finish	WOA/WWA/WGA/WNP/WBA	57
Wood Veneer (Walnut)	VWS	67
Solid Surface		
Yukon Riverstone	STS-YUS	424
Black Onyx Mirage	STS-BLS	424
Hidden Space	STS-HIS	424
Kimberlite	STS-KIS	570

Specifiable Finishes

- Linoleum Choose from Forbo linoleum products on page 7
- Metal Choose from Memo Metal Powder Coat Finishes on page 7
- Wood Choose from Memo Wood Finishes on page 7
- Solid Surface Choose from Memo Solid Surface Finishes on page 7

Notes

For step-by-step specifications and quotes, access our live quote tool on our website.

Chord
Coffee Table
Designed by Standard Issue, 2019
Made in the USA.

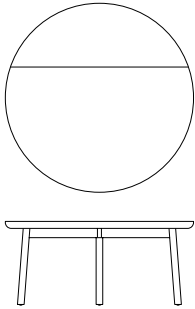

Depth	Width	Height
32"	32"	14.25"

Core Product	Core Code	List Price
Coffee Table	MM01-T3	1488

Standard with Core Product
Glides
Open Tray Surface
Powder Coated Steel Frame

Options

	Code	List Price Add
Large Insert Options		
Forbo Linoleum	FTL	464
Wood Veneer (Ash)	VAL	722
Clear Finish	WCA/WCW	0
Stain Finish	WOA/WWA/WGA/WNP/WBA	76
Wood Veneer (Walnut)	VWL	857
Small Insert Options		
No Insert (void)	XXS	0
Forbo Linoleum	FTS	40
Wood Veneer (Ash)	VAS	50
Clear Finish	WCA/WCW	0
Stain Finish	WOA/WWA/WGA/WNP/WBA	76
Wood Veneer (Walnut)	VWS	85
Solid Surface		
Yukon Riverstone	STS-YUS	659
Black Onyx Mirage	STS-BLS	659
Hidden Space	STS-HIS	659
Kimberlite	STS-KIS	900

Specifiable Finishes

- Linoleum** Choose from Forbo linoleum products on page 7
- Metal** Choose from Memo Metal Powder Coat Finishes on page 7
- Wood** Choose from Memo Wood Finishes on page 7
- Solid Surface** Choose from Memo Solid Surface Finishes on page 7

Notes

For step-by-step specifications and quotes, access our live quote tool on our website.

Chroma
Lounge
Designed by Harri Koskinen, 2019
Made in the USA.

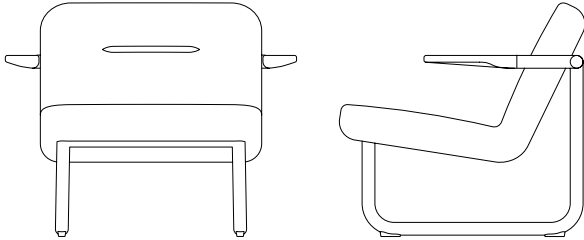

Depth Width Height
28.75" 33.75" 27.5"

Core Product Core Code
Lounge HK01-01

Textile Yardage Seat Back Arms
Total: 2.0 n/a n/a n/a

List Price by Textile Grade

	COM / 1	2	3	4	5	6	7	8	9	10	11	12	13	14	15
HK01-01	3328	3350	3372	3390	3412	3440	3474	3510	3552	3608	3678	3748	3852	4000	4148

Standard with Core Product
Ash Arms
Non-Marring Glides
High Resilience Polyurethane Foam

Options	Component	Code	List Price Add
Ash Arms with Stain		WOA/WBA	21
		WWA	56
		WGA/WNP/WBA	91
Walnut Arms		WCW	294

Specifiable Finishes

Metal Choose from Memo Metal Powder Coat Finishes on page 7
Textiles Choose from Camira, Maharam, or Kvadrat textiles on page 80, or contact Memo for assistance with COM fabrics
Wood Choose from Memo Wood Finishes on page 7

Notes

Due to the continuous seat and back, multiple textiles are not permitted on Chroma Lounge
For step-by-step specifications and quotes, access our live quote tool on our website.

Chroma

Lounge, Armless

Designed by Harri Koskinen, 2019

Made in the USA.

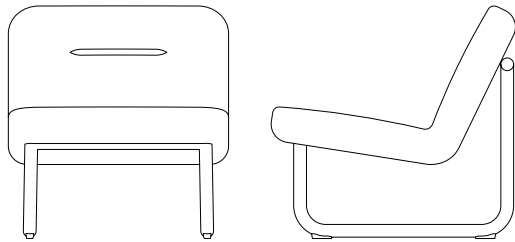

Depth	Width	Height
28.75"	26"	27.5"

Core Product	Core Code
Lounge, Armless	HK01-09

Textile Yardage	Seat	Back	Arms
Total: 2.0	n/a	n/a	n/a

List Price by Textile Grade

	COM / 1	2	3	4	5	6	7	8	9	10	11	12	13	14	15
HK01-09	2754	2776	2798	2816	2838	2866	2900	2936	2978	3034	3104	3174	3278	3426	3574

Standard with Core Product

Non-Marring Glides

High Resilience Polyurethane Foam

Specifiable Finishes

Metal Choose from Memo Metal Powder Coat Finishes on page 7

Textiles Choose from Camira, Maharam, or Kvadrat textiles on page 80, or contact Memo for assistance with COM fabrics

Notes

Due to the continuous seat and back, multiple textiles are not permitted on Chroma Lounge

For step-by-step specifications and quotes, access our live quote tool on our website.

Chroma

Lounge, Swivel

Designed by Harri Koskinen, 2019

Made in the USA.

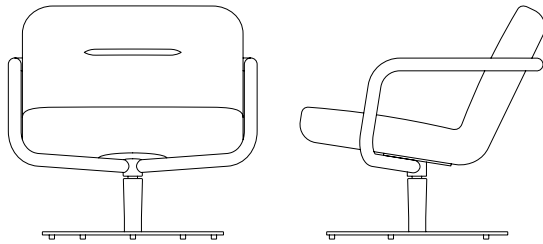

Depth	Width	Height
28.75"	29.25"	27.5"

Core Product	Core Code
Lounge, Swivel	HK01-11

Textile Yardage	Seat	Back	Arms
Total: 2.0	n/a	n/a	n/a

List Price by Textile Grade

	COM / 1	2	3	4	5	6	7	8	9	10	11	12	13	14	15
HK01-11	3876	3898	3920	3938	33960	3988	4022	4058	4100	4156	4226	4296	4400	4548	4696

Standard with Core Product

Free swivel base

High Resilience Polyurethane Foam

Non-Marring Glides

Specifiable Finishes

Metal Choose from Memo Metal Powder Coat Finishes on page 7

Textiles Choose from Camira, Maharam, or Kvadrat textiles on page 80, or contact Memo for assistance with COM fabrics

Notes

Due to the continuous seat and back, multiple textiles are not permitted on Chroma Lounge

For step-by-step specifications and quotes, access our live quote tool on our website.

Chroma
Ottoman - 17
Designed by Harri Koskinen, 2019
Made in the USA.

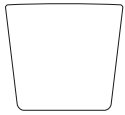
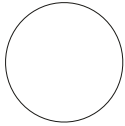

Depth	Width	Height
17.25"	17.25"	15.5"

Core Product	Core Code
Ottoman	HK01-00

Textile Yardage	Seat	Back	Arms
Total: 1.25	1.25	n/a	n/a

List Price by Textile Grade

	COM / 1	2	3	4	5	6	7	8	9	10	11	12	13	14	15
HK01-00	1056	1070	1084	1095	1109	1126	1148	1170	1196	1231	1275	1319	1384	1476	1569

Standard with Core Product
High Resilience Polyurethane Foam
Non-Marring Glides

Specifiable Finishes

Textiles Choose from Camira, Maharam, or Kvadrat textiles on page 80, or contact Memo for assistance with COM fabrics

Notes

For step-by-step specifications and quotes, access our live quote tool on our website.

Chroma

Ottoman - 24

Designed by Harri Koskinen, 2019

Made in the USA.

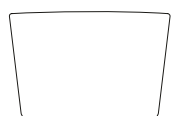
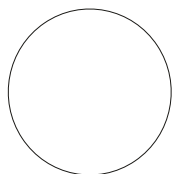

Depth	Width	Height
24"	24"	15.5"

Core Product	Core Code
Ottoman	HK01-24

Textile Yardage	Seat	Back	Arms
Total: 1.5	1.5	n/a	n/a

List Price by Textile Grade

	COM / 1	2	3	4	5	6	7	8	9	10	11	12	13	14	15
HK01-24	1380	1396	1413	1426	1443	1464	1489	1516	1548	1590	1642	1695	1773	1884	1995

Standard with Core Product

High Resilience Polyurethane Foam

Non-Marring Glides

Specifiable Finishes

Textiles Choose from Camira, Maharam, or Kvadrat textiles on page 80, or contact Memo for assistance with COM fabrics

Notes

For step-by-step specifications and quotes, access our live quote tool on our website.

Chroma

Ottoman - 29

Designed by Harri Koskinen, 2019

Made in the USA.

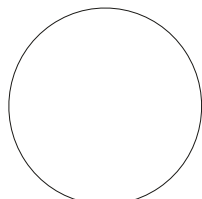

Depth	Width	Height
29"	29"	15.5"

Core Product	Core Code
Ottoman	HK01-29

Textile Yardage	Seat	Back	Arms
Total: 2	2	n/a	n/a

List Price by Textile Grade

	COM / 1	2	3	4	5	6	7	8	9	10	11	12	13	14	15
HK01-29	1595	1617	1639	1657	1679	1707	1741	1777	1819	1875	1945	2015	2119	2267	2415

Standard with Core Product

High Resilience Polyurethane Foam

Non-Marring Glides

Specifiable Finishes

Textiles Choose from Camira, Maharam, or Kvadrat textiles on page 80, or contact Memo for assistance with COM fabrics

Notes

For step-by-step specifications and quotes, access our live quote tool on our website.

Chroma

Ottoman - 38

Designed by Harri Koskinen, 2019

Made in the USA.

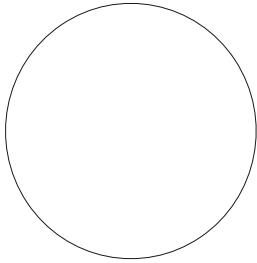

Depth	Width	Height
38"	38"	15.5"

Core Product	Core Code
Ottoman	HK01-38

Textile Yardage	Seat	Back	Arms
Total: 2.25	2.25	n/a	n/a

List Price by Textile Grade

	COM / 1	2	3	4	5	6	7	8	9	10	11	12	13	14	15
HK01-38	2077	2102	2127	2147	2172	2203	2242	2282	2329	2392	2471	2550	2667	2833	3000

Standard with Core Product

High Resilience Polyurethane Foam

Non-Marring Glides

Specifiable Finishes

Textiles Choose from Camira, Maharam, or Kvadrat textiles on page 80, or contact Memo for assistance with COM fabrics

Notes

For step-by-step specifications and quotes, access our live quote tool on our website.

Ida
Table
Designed by Nina Cho, 2022
Made in the USA.

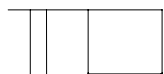
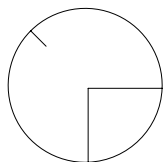

Depth	Width	Height
32"	32"	13.75"

Core Product	Core Code	List Price
Table	NC01-T1	5883

Options

	Code	List Price Add
Shelf Insert Options		
No Shelf Insert	XXS	0
Solid Wood Insert (Ash)	WAS	32
Solid Wood Insert (Ash + Stain)	WOA/WWA/WGA/WNP/WBA	93
Solid Wood Insert (Walnut)	WWS	434
Stone Insert (Marble)	STS	875

Specifiable Finishes

Metal	Choose from Memo Metal Powder Coat Finishes on page 7
Wood (shelf)	Choose from Memo Wood Finishes on page 7

Notes

For step-by-step specifications and quotes, access our live quote tool on our website.

Kino

Stool

Designed by Kensaku Oshiro, 2020

Made in the Canada, Assembled in the USA.

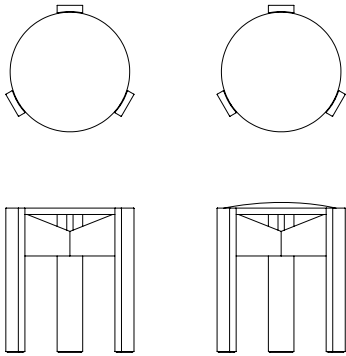

Depth	Width	Height
15.75"	15.75"	17.75 / 18.25"

Core Product	Core Code	List Price
Stool - Ash	KN01-S1-A	660
Stool - Walnut	KN01-S1-W	869

Standard with Core Product

Glides

Solid Wood Frame

Solid Wood Top

Textile Yardage	Seat
Total: .6	.6

List Price by Textile Grade*

	COM / 1	2	3	4	5	6	7	8	9	10	11	12	13	14	15
KN01-S1-A-UTT	902	908	915	920	927	935	946	956	969	986	1007	1028	1059	1103	1148
KN01-S1-W-UTT	1111	1117	1124	1129	1136	1144	1155	1165	1178	1195	1216	1237	1268	1312	1357

Standard with Core Product

Non-Marring Glides

High Resilience Polyurethane Foam

Options and Notes overleaf

Options

	Code	List Price Add
Upholstered Top	UTT	See previous page
Clear Finish (by species)	WCA	0
Stain Finish - Wood Top	WOA/WBA	27
	WWA	44
	WGA/WNP	71
Stain Finish - Upholstered Top	WOA/WBA	27
	WWA	44
	WGA/WNP	71

Specifiable Finishes

Wood Choose from Memo Wood Finishes on Page 7

Textiles Choose from Camira, Maharam, or Kvadrat textiles on page 80, or contact Memo for assistance with COM fabrics

Notes

For step-by-step specifications and quotes, access our live quote tool on our website.

Maru Benches

Three Slat Bench - 3/4-Length

Designed by Studio Gorm, 2020

Made in the USA.



Depth	Width	Height
17.75"	65.5"	17"

Core Product

Three Slat Bench - 3/4-Length - Ash

Core Code

SG03-IND-S3-66W-A

Standard with Core Product

Glides

Solid Ash Wood Frame

Upholstery Configurations

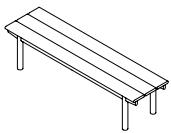

Configuration 1.3-S
(none)

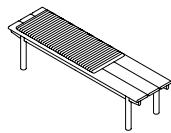

Configuration 2.3-S
-PC2

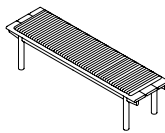

Configuration 3.3-S
-P60D2

Textile Yardage

Pad, Long (60"): 2.75 (each)

Pad, Standard: 1.50 (each)

Upholstery Configurations - List Price by Textile Grade

	Base	COM / 1	2	3	4	5	6	7	8	9	10	11	12	13	14	15
Configuration 1.3-S	6507	n/a	n/a	n/a	n/a	n/a	n/a	n/a	n/a	n/a	n/a	n/a	n/a	n/a	n/a	n/a
Configuration 2.3-S		7157	7173	7190	7203	7220	7241	7266	7293	7325	7367	7416	7472	7550	7661	7772
Configuration 3.3-S		7321	7343	7365	7383	7405	7433	7467	7503	7545	7601	7667	7741	7845	7993	8141

Options and Notes overleaf

Options

Wood Species	Code	List Price Add
Ash	A	0
Walnut	W	2154

Wood Finishes		
Clear over Ash/Walnut	WCA/WCW	0
Ash with Stain Finish	WOA/WWA	298

Accessories (see below for visuals)

Table, Round, Ash Veneer	T1	527
Table, Obround, Ash Veneer	T2	580
Power Module/s	PM1	350

Other Options

Veneer Round Table Top(s), Walnut	VTW	85 (per table)
Veneer Obround Table Top(s), Walnut	VTW	94 (per table)
Veneer Round Table Top(s), Ash with Stain	WOA/WWA	53 (per table)
Veneer Obround Table Top(s), Ash with Stain	WOA/WWA	58 (per table)

Specifiable Finishes

Textiles Choose from Camira, Desingtex, Kvadrat, or Maharam textiles on page 80, contact Memo for assistance with COM fabrics
 Wood/Veneer Choose from Memo Wood Finishes on page 7

Notes

For step-by-step specifications and quotes, access our live quote tool on our website.

Accessories (visuals)

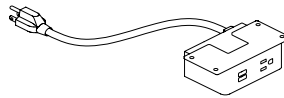
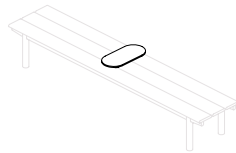
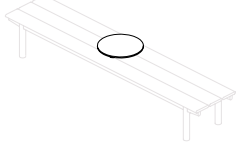

Table, Round
See below for locations

Table, Obround
See below for locations

Power Module
1-Power, 2-USB

Table Locations (Round Table shown)

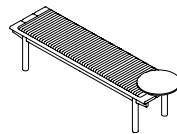
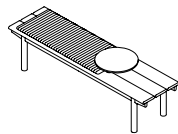
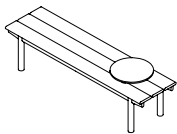

-T1F2
For Configurations 1.3-5

-T1E2
For Configuration 2.3-5

-T1G2
For Configuration 3.3-5

Maru Benches

Three Slat Bench

Designed by Studio Gorm, 2020

Made in the USA.



Depth	Width	Height
17.75"	85.5"	17"

Core Product

Three Slat Bench - Ash

Core Code

SG03-IND-S3-86W-A

Standard with Core Product

Glides

Solid Ash Wood Frame

Upholstery Configurations

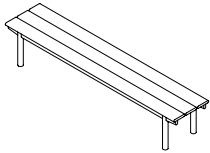

Configuration 1.3
(none)

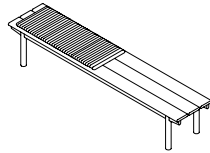

Configuration 2.3
-PC2

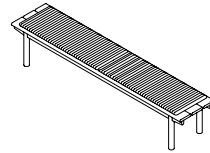

Configuration 3.3
-PC2-PG2

Textile Yardage

Pad: 1.50 (each)

Upholstery Configurations - List Price by Textile Grade

	Base COM / 1	2	3	4	5	6	7	8	9	10	11	12	13	14	15
Configuration 1.3	7077	n/a	n/a	n/a	n/a	n/a	n/a	n/a	n/a	n/a	n/a	n/a	n/a	n/a	n/a
Configuration 2.3	7727	7743	7760	7773	7790	7811	7836	7863	7895	7937	7986	8042	8120	8231	8342
Configuration 3.3	8376	8409	8442	8469	8502	8544	8595	8649	8712	8796	8895	9006	9162	9384	9606

Options and Notes overleaf

Options

Wood Species	Code	List Price Add
Ash	A	0
Walnut	W	2657

Wood Finishes

Clear over Ash/Walnut	WCA/WCW	0
Ash with Stain Finish	WOA/WWA	326

Accessories (see below for visuals)

Table, Round, Ash Veneer	T1	527
Table, Obround, Ash Veneer	T2	580
Power Module/s	PM1/PM2	350/805

Other Options

Veneer Round Table Top(s), Walnut	VTW	85 (per table)
Veneer Obround Table Top(s), Walnut	VTW	94 (per table)
Veneer Round Table Top(s), Ash with Stain	WOA/WWA	53 (per table)
Veneer Obround Table Top(s), Ash with Stain	WOA/WWA	58 (per table)

Specifiable Finishes

Textiles Choose from Camira, Designitix, Kvadrat, or Maharam textiles on page 80, contact Memo for assistance with COM fabrics
 Wood/Veneer Choose from Memo Wood Finishes on page 7

Notes

For step-by-step specifications and quotes, access our live quote tool on our website.

Accessories (visuals)

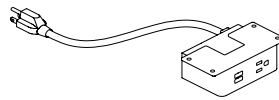
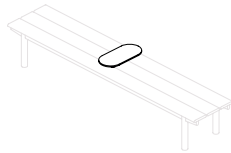
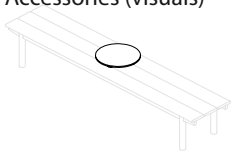

Table, Round
See below for locations

Table, Obround
See below for locations

Power Module
1-Power, 2-USB

Table Locations (Round Table shown)

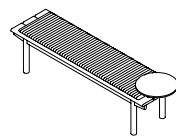
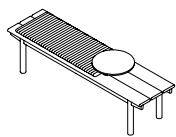
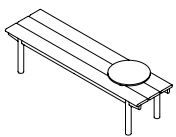

-T1F2
For Configurations 1.3-5

-T1E2
For Configuration 2.3-5

-T1G2
For Configuration 3.3-5

Orca

Vertical Screen

Designed by Alex Brokamp , 2020

Made in the USA.

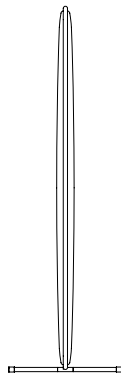
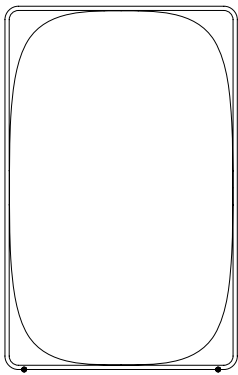
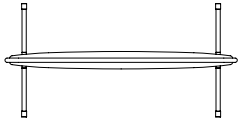

Depth	Width	Height
20"	40.9"	64.3"

Core Product	Core Code
Vertical Screen	AB01-V

List Price by Textile Grade*

	COM / 1	2	3	4	5	6	7	8	9	10	11	12	13	14	15
AB01-V	2014	2055	2096	2130	2171	2224	2288	2355	2434	2539	2670	2801	2996	3274	3551

*Pricing assumes a single textile selection for both sides. For multiple textiles please visit [Quotes](#)

Textiles

AB01 screens are available in select textiles that meet ASTM-E84 Unadhered Testing and are suitable for panel applications.

Choose From:

Camira Lucia T2T (Group 5)	Designtex Woolish (Group 5)	Kvadrat Remix (Group 9)	Maharam Murmur (Group 5)
Camira Blaze (Group 8)	Designtex Dovetail (Group 7)	Kvadrat Melange Nap (Group 11)	Maharam Arlo (Group 8)

Textile Yardage	Side A	Side B
Total: 3.75	1.875	1.875

Standard with Core Product

Steel Frame with Black Powdercoat

Upholstered Field

Non-marring glides

Options

Component	Code	List Price Add
Multiple Textiles (Side A / Side B)	TA	140
Casters	CA	100

Specifiable Finishes

Textiles Choose from Camira, Designtex, Kvadrat, or Maharam textiles on previous page

Notes

Multiple Textile option allows for separate textiles on each side
For step-by-step specifications and quotes, access our live quote tool on our website.

Orca

Horizontal Screen

Designed by Alex Brokamp , 2020

Made in the USA.

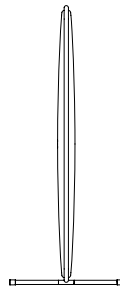
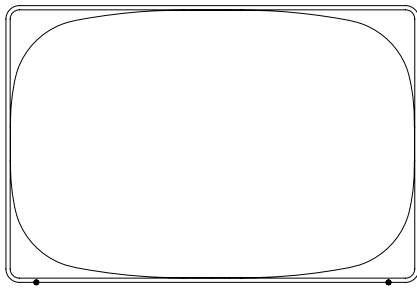
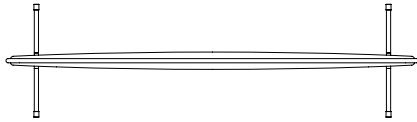

Depth	Width	Height
20"	72.9"	49.3"

Core Product	Core Code
Horizontal Screen	AB01-H

List Price by Textile Grade*

	COM / 1	2	3	4	5	6	7	8	9	10	11	12	13	14	15
AB01-H	1956	2003	2050	2088	2135	2194	2267	2343	2432	2551	2700	2849	3070	3384	3699

Textiles

AB01 screens are available in select textiles that meet ASTM-E84 Unadhered Testing and are suitable for panel applications.

Choose From:

Camira Lucia T2T (Group 5)	Designtex Woolish (Group 5)	Kvadrat Remix (Group 9)	Maharam Murmur (Group 5)
Camira Blaze (Group 8)	Designtex Dovetail (Group 7)	Kvadrat Melange Nap (Group 11)	Maharam Arlo (Group 8)

*Pricing assumes a single textile selection for both sides. For multiple textiles please visit [Quotes](#)

Textile Yardage	Side A	Side B
Total: 4.25	2.125	2.125

Standard with Core Product

Steel Frame with Black Powdercoat

Upholstered Field

Non-marring glides

Options

Component	Code	List Price Add
Multiple Textiles (Side A / Side B)	TA	140
Casters	CA	100

Specifiable Finishes

Textiles Choose from Camira, Designtex, Kvadrat, or Maharam textiles on previous page

Notes

Multiple Textile option allows for separate textiles on each side

For step-by-step specifications and quotes, access our live quote tool on our website.

Penna
Lounge
Designed by Studio Gorm, 2019
Made in the USA.

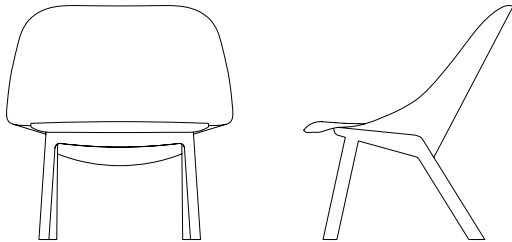

Depth Width Height
32" 25.5" 30"

Core Product	Core Code
Lounge - Ash	SG01-01-A
Lounge - Walnut	SG01-01-W

Textile Yardage	Seat	Back	Arms
Total: 2.5	.75	1.75	n/a

List Price by Textile Grade*

	COM / 1	2	3	4	5	6	7	8	9	10	11	12	13	14	15
SG01-01-A	2753	2780	2808	2830	2858	2893	2935	2980	3033	3103	3190	3278	3408	3593	3778
SG01-01-W	4265	4292	4320	4342	4370	4405	4447	4492	4545	4615	4702	4790	4920	5105	5290

*Pricing assumes a single textile selection for seat and back. For multiple textiles please visit [Quotes](#)

Standard with Core Product
Non-Marring Glides
High Resilience Polyurethane Foam

Options

Component	Code	List Price Add
Multiple Textiles (Seat/Back)	TA	140
Stain Finish on Base	WOA/WBA	54
	WWA	90
	WGA/WNP	126

Specifiable Finishes

Textiles Choose from Camira, Designtex, Kvadrat, or Maharam textiles on page 80, or contact Memo for assistance with COM
Wood Choose from Memo Wood Finishes on page 7

Notes

Multiple Textile option allows for separate seat and back textiles
For step-by-step specifications and quotes, access our live quote tool on our website.

Penna
 Large Round Table
 Designed by Studio Gorm, 2019
 Made in the USA.

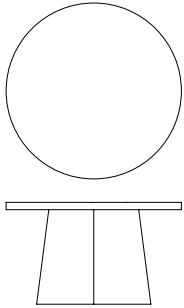

Depth	Width	Height
30"	30"	17.5"

Core Product	Core Code	List Price
Large Round Table - Ash	SG01-T1-A	2322
Large Round Table - Walnut	SG01-T1-W	2543

Standard with Core Product
 Glides
 Forbo Linoleum Top
 Solid Wood Edge Band (finish to match base)
 Wood Veneer Base

Options

Component	Code	List Price Add
Forbo Linoleum Top	FTT	0
Wood Veneer Top (Ash)	VTA	171
Wood Veneer Top (Walnut)	VTW	257
Ash with Stain Finish	WOA/WBA	100
	WWA	110
	WGA/WNP	120
Power Module (2-power, 2-USB)	PM1	361

Specifiable Finishes

Linoleum Choose from Forbo linoleum products on page 7
 Wood Choose from Memo Wood Finishes on page 7

Notes

For step-by-step specifications and quotes, access our live quote tool on our website.

Penna

Obround Table

Designed by Studio Gorm, 2019

Made in the USA.

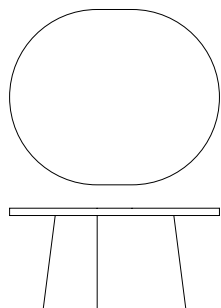

Depth	Width	Height
30"	36"	17.5"

Core Product	Core Code	List Price
Obround Table - Ash	SG01-T2-A	2478
Obround Table - Walnut	SG01-T2-W	2709

Standard with Core Product

Glides

Forbo Linoleum Top

Solid Wood Edge Band (finish to match base)

Wood Veneer Base

Options

Component	Code	List Price Add
Forbo Linoleum Top	FTT	0
Wood Veneer Top (Ash)	VTA	158
Wood Veneer Top (Walnut)	VTW	287
Ash with Stain Finish	WOA/WBA	110
	WWA	120
	WGA/WNP	130
Power Module (2-power, 2-USB)	PM1	361

Specifiable Finishes

Linoleum Choose from Forbo linoleum products on page 7

Wood Choose from Memo Wood Finishes on page 7

Notes

For step-by-step specifications and quotes, access our live quote tool on our website.

Penna
Small Round Table
Designed by Studio Gorm, 2019
Made in the USA.

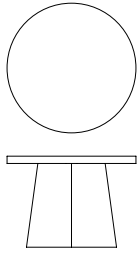

Depth	Width	Height
22.5"	22.5"	16"

Core Product	Core Code	List Price
Small Round Table - Ash	SG01-T3-A	2060
Small Round Table - Walnut	SG01-T3-W	2260

Standard with Core Product
Glides
Forbo Linoleum Top
Solid Wood Edge Band (finish to match base)
Wood Veneer Base

Options

Component	Code	List Price Add
Forbo Linoleum Top	FTT	0
Wood Veneer Top (Ash)	VTA	141
Wood Veneer Top (Walnut)	VTW	186
Ash with Stain Finish	WOA/WBA	90
	WWA	100
	WGA/WNP	110
PowerModule (2-power, 2-USB)	PM1	361

Specifiable Finishes

Linoleum Choose from Forbo linoleum products on page 7
Wood Choose from Memo Wood Finishes on page 7

Notes

For step-by-step specifications and quotes, access our live quote tool on our website.

Penna

Bar Table

Designed by Studio Gorm, 2020

Made in the USA.

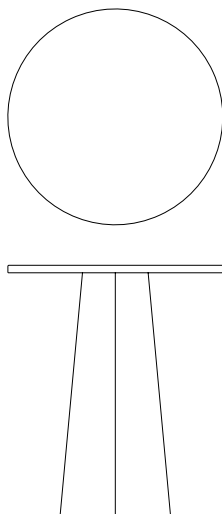

Depth	Width	Height
36"	36"	42"

Core Product	Core Code	List Price
Bar Table - Ash	SG01-T8-36D-A	3806
Bar Table - Walnut	SG01-T8-36D-W	4015

Standard with Core Product

Glides

Forbo Linoleum Top

Solid Wood Edge Band (finish to match base)

Wood Veneer Base

Options

Component	Code	List Price Add
Forbo Linoleum Top	FTT	0
Wood Veneer Top (Ash)	VTA	234
Wood Veneer Top (Walnut)	VTW	305
Ash with Stain Finish	WOA/WBA	110
	WWA	130
	WGA/WNP	150
Power Module (2-power, 2-USB)	PM1	361

Specifiable Finishes

Linoleum Choose from Forbo linoleum products on page 7

Wood Choose from Memo Wood Finishes on page 7

Notes

Bases ship with sandbags in certain models, for ballast

For step-by-step specifications and quotes, access our live quote tool on our website.

Penna
Café Table
Designed by Studio Gorm, 2020
Made in the USA.

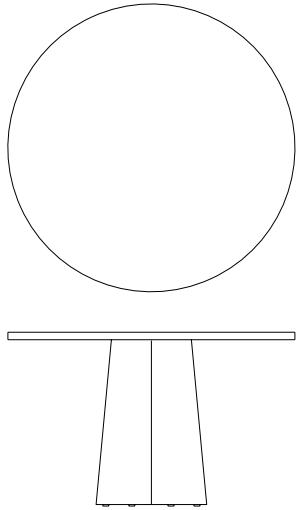

Depth	Width	Height
48"	48"	29"

Core Product	Core Code	List Price
Café Table - Ash	SG01-T6-48D-A	3898
Café Table - Walnut	SG01-T6-48D-W	4194

Standard with Core Product

- Glides
- Forbo Linoleum Top
- Solid Wood Edge Band (finish to match base)
- Wood Veneer Base

Options

Component	Code	List Price Add
Forbo Linoleum Top	FTT	0
Wood Veneer Top (Ash)	VTA	249
Wood Veneer Top (Walnut)	VTW	317
Ash with Stain Finish	WOA/WBA	100
	WWA	120
	WGA/WNP	140
Power Module (2-power, 2-USB)	PM1	361

Specifiable Finishes

- Linoleum Choose from Forbo linoleum products on page 7
- Wood Choose from Memo Wood Finishes on page 7

Notes

Bases ship with sandbags in certain models, for ballast

For step-by-step specifications and quotes, access our live quote tool on our website.

Penna
Meeting Table
Designed by Studio Gorm, 2020
Made in the USA.

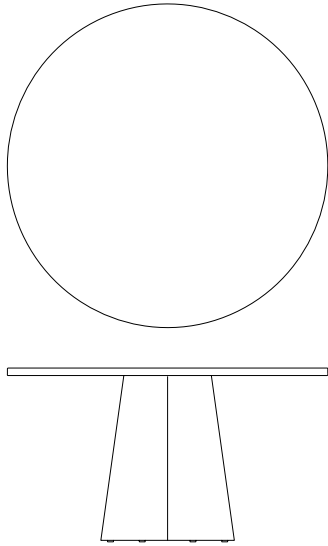

Depth	Width	Height
54"	54"	29"

Core Product	Core Code	List Price
Meeting Table - Ash	SG01-T7-54D-A	3980
Meeting Table - Walnut	SG01-T7-54D-W	4331

Standard with Core Product

- Glides
- Forbo Linoleum Top
- Solid Wood Edge Band (finish to match base)
- Wood Veneer Base

Options

Component	Code	List Price Add
Forbo Linoleum Top	FTT	0
Wood Veneer Top (Ash)	VTA	296
Wood Veneer Top (Walnut)	VTW	400
Ash with Stain Finish	WOA/WBA	100
	WWA	120
	WGA/WNP	140
Power Module (2-power, 2-USB)	PM1	3

Specifiable Finishes

- Linoleum Choose from Forbo linoleum products on page 7
- Wood Choose from Memo Wood Finishes on page 7

Notes

Bases ship with sandbags in certain models, for ballast

For step-by-step specifications and quotes, access our live quote tool on our website.

Penna
Height Adjustable Café Table
Designed by Studio Gorm, 2020
Made in the USA.

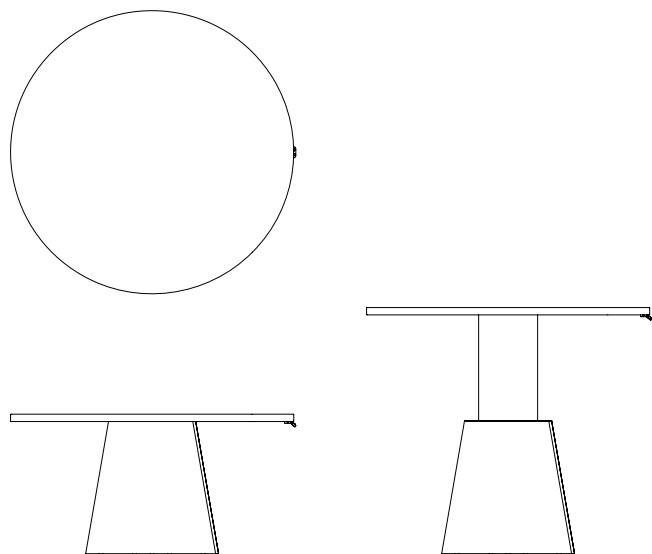

Depth	Width	Height
48"	48"	24" - 42"

Core Product	Core Code	List Price
Café Table - Ash	SG01-T6-HAT-48D-A-MA	7443
Café Table - Walnut	SG01-T6-HAT-48D-W-MA	7849

Standard with Core Product
Glides
Forbo Linoleum Top
Solid Wood Edge Band (finish to match base)
Wood Veneer Base

Options

Component	Code	List Price Add
Forbo Linoleum Top	FTT	0
Wood Veneer Top (Ash)	VTA	254
Wood Veneer Top (Walnut)	VTW	332
Ash with Stain Finish	WOA/WBA	160
	WWA	180
	WGA/WNP	200
Adjustable Height Column Shroud	PEW/PCY/PFG/POB/PBO/PSG/PDP	0

Specifiable Finishes and Notes overleaf

Specifiable Finishes

- Linoleum Choose from Forbo linoleum products on page 7
- Wood Choose from Memo Wood Finishes on page 7
- Painted Wood PEW/PCY/PFG/POB/PBO/PSG/PDP

Notes

Bases ship with sandbags in certain models, for ballast

For step-by-step specifications and quotes, access our live quote tool on our website.

Penna
Height Adjustable Meeting Table
Designed by Studio Gorm, 2020
Made in the USA.

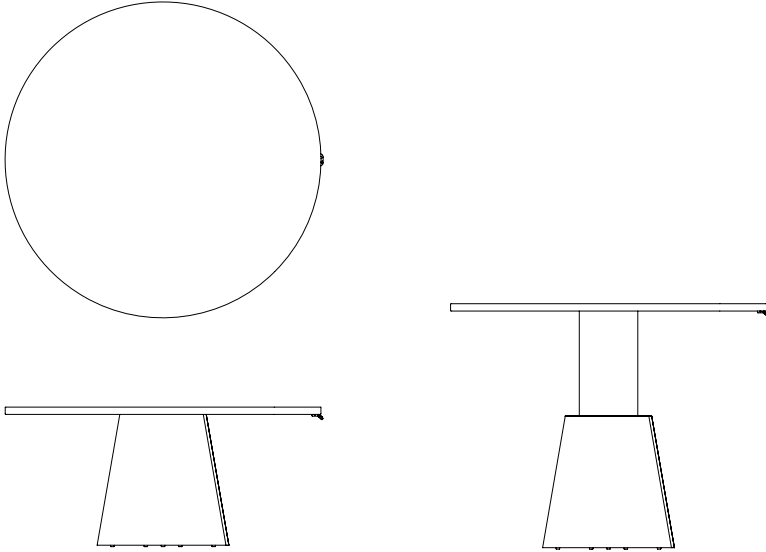

Depth	Width	Height
54"	54"	24" - 42"

Core Product	Core Code	List Price
Meeting Table - Ash	SG01-T7-HAT-54D-A-MA	7482
Meeting Table - Walnut	SG01-T7-HAT-54D-W-MA	7891

Standard with Core Product

- Glides
- Forbo Linoleum Top
- Solid Wood Edge Band (finish to match base)
- Wood Veneer Base

Options

Component	Code	List Price Add
Forbo Linoleum Top	FTT	0
Wood Veneer Top (Ash)	VTA	254
Wood Veneer Top (Walnut)	VTW	332
Ash with Stain Finish	WOA/WBA	160
	WWA	180
	WGA/WNP	200
Adjustable Height Column Shroud	PEW/PCY/PFG/POB/PBO/PSG/PDP	0

Specifiable Finishes and Notes overleaf

Specifiable Finishes

- Linoleum Choose from Forbo linoleum products on page 7
- Wood Choose from Memo Wood Finishes on page 7
- Painted Wood PEW/PCY/PFG/POB/PBO/PSG/PDP

Notes

Bases ship with sandbags in certain models, for ballast

For step-by-step specifications and quotes, access our live quote tool on our website.

Penna

Height Adjustable Café Table

Designed by Studio Gorm, 2020

Made in the USA.

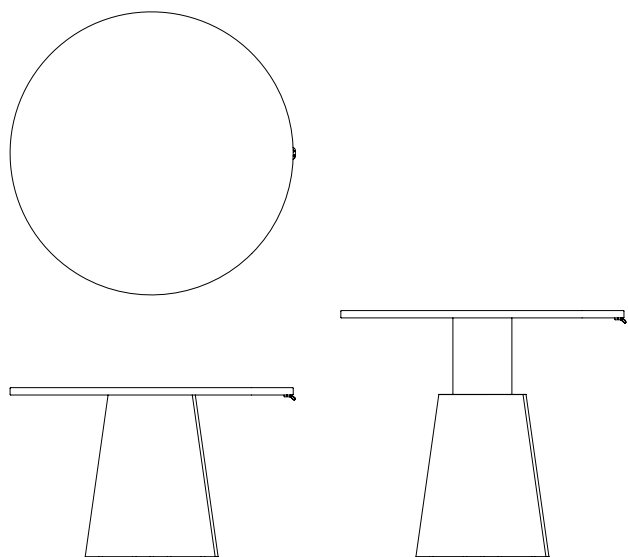

Depth	Width	Height
48"	48"	29" - 42"

Core Product	Core Code	List Price
Café Table - Ash	SG01-T6-HAT-48D-A-MB	7550
Café Table - Walnut	SG01-T6-HAT-48D-W-MB	7917

Standard with Core Product

- Glides
- Forbo Linoleum Top
- Solid Wood Edge Band (finish to match base)
- Wood Veneer Base

Options

Component	Code	List Price Add
Forbo Linoleum Top	FTT	0
Wood Veneer Top (Ash)	VTA	244
Wood Veneer Top (Walnut)	VTW	380
Ash with Stain Finish	WOA/WBA	160
	WWA	180
	WGA/WNP	200
Adjustable Height Column Shroud	PEW/PCY/PFG/POB/PBO/PSG/PDP	0

Specifiable Finishes and Notes overleaf

Specifiable Finishes

- Linoleum Choose from Forbo linoleum products on page 7
- Wood Choose from Memo Wood Finishes on page 7
- Painted Wood PEW/PCY/PFG/POB/PBO/PSG/PDP

Notes

Bases ship with sandbags in certain models, for ballast

For step-by-step specifications and quotes, access our live quote tool on our website.

Penna
Height Adjustable Meeting Table
Designed by Studio Gorm, 2020
Made in the USA.

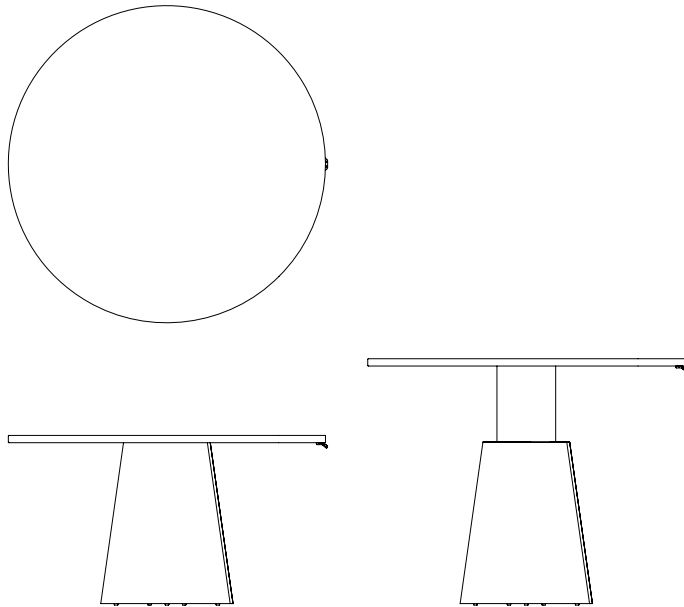

Depth	Width	Height
54"	54"	29" - 42"

Core Product	Core Code	List Price
Meeting Table - Ash	SG01-T7-HAT-54D-A-MB	7589
Meeting Table - Walnut	SG01-T7-HAT-54D-W-MB	7959

Standard with Core Product

- Glides
- Forbo Linoleum Top
- Solid Wood Edge Band (finish to match base)
- Wood Veneer Base

Options

Component	Code	List Price Add
Forbo Linoleum Top	FTT	0
Wood Veneer Top (Ash)	VTA	244
Wood Veneer Top (Walnut)	VTW	380
Ash with Stain Finish	WOA/WBA	160
	WWA	180
	WGA/WNP	200
Adjustable Height Column Shroud PEW/PCY/PFG/POB/PBO/PSG/PDP		0

Specifiable Finishes and Notes overleaf

Specifiable Finishes

- Linoleum Choose from Forbo linoleum products on page 7
- Wood Choose from Memo Wood Finishes on page 7
- Painted Wood PEW/PCY/PFG/POB/PBO/PSG/PDP

Notes

Bases ship with sandbags in certain models, for ballast

For step-by-step specifications and quotes, access our live quote tool on our website.

Rolo

Lounge

Designed by Studio Tolvanen, 2021

Made in the USA.

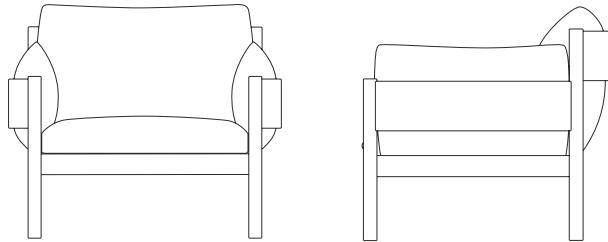

Depth	Width	Height
32"	36"	31"

Core Product	Core Code
Lounge - Ash	ST01-01-A
Lounge - Walnut	ST01-01-W

Textile Yardage

Total: 5.25

List Price by Textile Grade*

	COM / 1	2	3	4	5	6	7	8	9	10	11	12	13	14	15
ST01-01-A	4316	4374	4432	4479	4537	4610	4700	4794	4904	5051	5235	5419	5692	6080	6469
ST01-01-W	5419	5549	5607	5654	5712	5785	5875	5969	6079	6226	6410	6594	6876	7255	7644

*Pricing assumes non-railroaded textiles. For railroaded pricing please contact us at info@memofurniture.com

Standard with Core Product

Non-Marring Glides

High Resilience Polyurethane Foam

Options

	Code	List Price Add
Clear Finish (by species)	WCA/WCW	0
Ash with Stain Finish	WOA/WBA	83
	WWA	132
	WGA/WNP	198

Specifiable Finishes

Textiles Choose from Camira, Deisgntex, Kvradrat, or Maharam textiles on page 80, or contact Memo for assistance with COM fabrics

Wood Choose from Memo Wood Finishes on page 7

Notes

For step-by-step specifications and quotes, access our live quote tool on our website.

Rolo

Loveseat

Designed by Studio Tolvanen, 2021

Made in the USA.

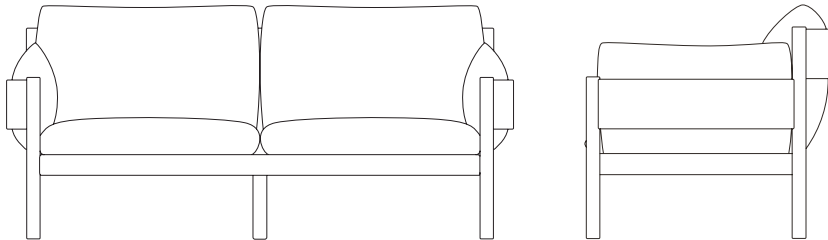

Depth	Width	Height
32"	65"	31"

Core Product	Core Code
Loveseat - Ash	ST01-02-A
Loveseat - Walnut	ST01-02-W

Textile Yardage

Total: 8.25

List Price by Textile Grade*

	COM / 1	2	3	4	5	6	7	8	9	10	11	12	13	14	15
ST01-02-A	6446	6537	6628	6702	6793	6908	7049	7197	7370	7601	7890	8179	8608	9218	9829
ST01-02-W	8533	8624	8715	8789	8800	8995	9136	9284	9457	9688	9977	10266	10695	11305	11916

*Pricing assumes non-railroaded textiles. For railroaded pricing please contact us at info@memofurniture.com

Standard with Core Product

Non-Marring Glides

High Resilience Polyurethane Foam

Options

	Code	List Price Add
Clear Finish (by species)	WCA/WCW	0
Ash with Stain Finish	WOA/WBA	96
	WWA	152
	WGA/WNP	231

Specifiable Finishes

Textiles Choose from Camira, Designtex, Kvadrat, or Maharam textiles on page 80, or contact Memo for assistance with COM fabrics

Wood Choose from Memo Wood Finishes on page 7

Notes

For step-by-step specifications and quotes, access our live quote tool on our website.

Rolo
Sofa
Designed by Studio Tolvanen, 2021
Made in the USA.

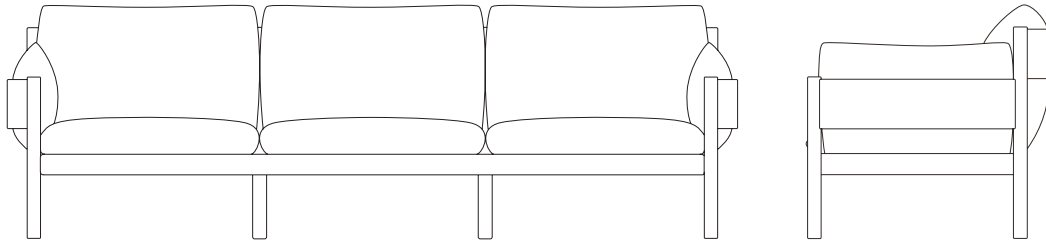

Depth Width Height
32" 94" 31"

Core Product	Core Code
Sofa - Ash	ST01-03-A
Sofa - Walnut	ST01-03-W

Textile Yardage
Total: 11.5

List Price by Textile Grade*

	COM / 1	2	3	4	5	6	7	8	9	10	11	12	13	14	15
ST01-03-A	8939	9065	9192	8835	8962	9123	9318	9525	9767	10089	10468	10894	11492	12343	13194
ST01-03-W	11190	11316	11443	11546	11673	11834	12029	12236	12478	12800	13202	13605	14203	15054	15905

*Pricing assumes non-railroaded textiles. For railroaded pricing please contact us at info@memofurniture.com

Standard with Core Product
Non-Marring Glides
High Resilience Polyurethane Foam

Options

	Code	List Price Add
Clear Finish (by species)	WCA/WCW	0
Ash with Stain Finish	WOA/WGA	116
	WWA	175
	WGA/WNP	264

Specifiable Finishes

Textiles Choose from Camira, Designtex, Kvadrat, or Maharam textiles on page 80, or contact Memo for assistance with COM fabrics
Wood Choose from Memo Wood Finishes on page 7

Notes

For step-by-step specifications and quotes, access our live quote tool on our website.

Rolo

Side Table

Designed by Studio Tolvanen, 2021

Made in the USA.

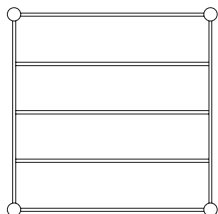

Depth	Width	Height
27.75"	27.75"	11"

Core Product	Core Code	List Price
Side Table - Ash	ST01-T1-A	1366
Side Table - Walnut	ST01-T1-W	1774

Standard with Core Product

Glides

Options

Specifiable Finishes

Choose from Memo Wood Finishes on page 7

	Code	List Price Add
Clear Finish (by species)	WCA/WCW	0
Ash with Stain Finish	WOA/WBA	96
	WWA	152
	WGA/WNP	231

Notes

For step-by-step specifications and quotes, access our live quote tool on our website.

Rolo

Coffee Table

Designed by Studio Tolvanen, 2021

Made in the USA.

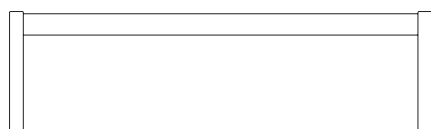
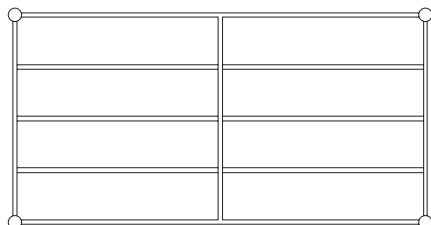

Depth	Width	Height
27.75"	53.75"	15"

Core Product	Core Code	List Price
Coffee Table - Ash	ST01-T2-A	1987
Coffee Table - Walnut	ST01-T2-W	2580

Standard with Core Product

Glides

Options

Specifiable Finishes

Choose from Memo Wood Finishes on page 7

	Code	List Price Add
Clear Finish (by species)	WCA/WCW	0
Ash with Stain Finish	WOA/WBA	116
	WWA	175
	WGA/WNP	264

Notes

For step-by-step specifications and quotes, access our live quote tool on our website.

Textiles Graded-in sorted by pattern name Camira

Pattern Name	Group
Blazer	8
Carragan Flax	11
Era	2
Gravity	2
Lucia T2T	5
Main Line Flax	7
Monochrome Set	7
Oceanic	7
Sumi	7
Synergy	8

Textiles Graded-in sorted by pattern name Kvadrat, cont.

Pattern Name	Group
Hallingdal 65	12
Melange Nap	11
Re-wool	10
Remix 3	9
Sisu	14
Steelcut 2	11
Steelcut Trio 3	11
Tonica 2	10

Textiles Graded-in sorted by pattern name Designtex

Pattern Name	Group
Alphabet	7
Billiard Cloth	9
Brushed Flannel	7
Checker	11
Dovetail	5
Everywhere Texture	9
Gamut	5
Hashtag	8
Microweed	10
Overtone	5
Rein	6
Rocket	7
Tour	7
Tweedy Twill	6
Woolish	7

Textiles Graded-in sorted by pattern name Maharam

Arlo	466598	8
Article	458600	6
Beck	466570	10
Brindle	466418	8
Campana	466571	12
Chapter	466610	??
Compound	466196	10
Darning Sampler Plaid	466462	15
Felix	466625	12
Firma	466582	12
Gemma	466568	12
Gemma Multi	466569	12
Hearth	466536	13
Isa	466624	12
Jasper	466563	10
Lariat	440401	4
Manner	466177	5
Mantle	466517	8
Meld	466387	5
Merit	458600	6
Messenger	458640	5
Metaphor	466553	5
Metric	466014	5
Method	466579	5
Mode	466337	6
Murmur	466446	5
Muse	466487	4
Nico	466564	9
Nova	466620	15
Province	466549	12

Textiles Graded-in sorted by pattern name Kvadrat

Pattern Name	Group
Arda (Febrik)	13
Canvas 2	10
Coda 2	13
Divina MD	11
Divina Melange 3	11

Textiles Graded-in sorted by Grading Group: Camira

Group & Price/yard	Pattern Name
Group 1 53	
Group 2 64	Era
Group 3 75	Gravity
Group 4 84	
Group 5 95	Lucia T2T
Group 6 109	
Group 7 126	Main Line FLax Monochrome Set Oceanic Sumi
Group 8 144	Blazer Synergy
Group 9 165	
Group 10 193	
Group 11 228	Craggen FLax

Textiles Graded-in sorted by Grading Group: Kvadrat

Group & Price/yard	Pattern Name
Group 1 53	
Group 2 64	
Group 3 75	
Group 4 84	
Group 5 95	
Group 6 109	
Group 7 126	
Group 8 144	
Group 9 165	Remix 3
Group 10 193	Canvas 2 Re-wool Tonica 2
Group 11 228	Divina MD Divina Melange 3 Melange Nap Steelcut 2 Steelcut Trio 3
Group 12 263	Hallingdal 65
Group 13 315	Arda Coda 2
Group 14	Sisu

Textiles Graded-in sorted by Grading Group: Designtex

Group & Price/yard	Pattern Name
Group 1 53	
Group 2 64	
Group 3 75	
Group 4 84	
Group 5 95	Dovetail Gamut Overtone
Group 6 109	Tweedy Twill
Group 7 126	Brushed Flannel Rocket Woolish
Group 8 144	Hashtag
Group 9 165	Billiard Cloth Everywhere Texture
Group 10 193	Microtweed
Group 11 228	Checker

Textiles Graded-in sorted by Grading Group: Maharam

Group 1	53		
Group 2	64		
Group 3	75		
Group 4	84	Lariat	440401
		Muse	466487
Group 5	95	Manner	466177
		Meld	466387
		Messenger	458640
		Metaphor	466553
		Method	466579
		Metric	466014
		Murmur	466446
Group 6	109	Article	458600
		Merit	458600
		Mode	466337
Group 7	126		
Group 8	144	Arlo	466598
		Brindle	466418
		Mantle	466517
Group 9	165	Nico	466564
Group 10	193	Beck	463770
		Compound	466196
		Jasper	466563
Group 11	228		
Group 12	263	Campana	466571
		Felix	466625
		Firma	466582
		Gemma	466568
		Gemma Multi	466469
		Isa	466624
		Province	466549
Group 13	315	Chapter	466610
		Hearth	466536
Group 14	389		
Group 15	463	Darning Sampler Plaid	466462
		Nova	466620

memo

Thank You

memo